



deca 

CATÁLOGO GERAL DE PRODUTOS

CATÁLOGO GERAL DE PRODUTOS

Sinônimo de design, tecnologia e inovação, a Deca é uma marca que está sempre buscando o melhor para você. Por isso desenvolve constantemente novos produtos e sistemas que garantem um toque especial de conforto e sofisticação no seu dia-a-dia.

Bem-vindo ao mundo Deca.

A DECA

A Deca é uma empresa de capital nacional que faz parte do Grupo Duratex, integrante da holding Itausa S.A.

Desde 1947, a empresa ocupa lugar de destaque no cenário nacional, no desenvolvimento de louças e metais sanitários de alta qualidade para o mercado brasileiro e também para o exterior, somando atualmente mais de 1.200 itens de louças e 5.000 de metais em seu portfólio.

A Deca investe continuamente no desenvolvimento de novos produtos, incluindo economizadores de água e produtos com design inovador. As fábricas estão localizadas, em território nacional, em São Paulo (SP), Jundiaí (SP), São Leopoldo (RS), Recife (PE) e João Pessoa (PB), além de uma unidade no exterior na Argentina. A produção nacional gira em torno de 18 milhões de metais e 13,5 milhões de louças por ano.

Com certificação ISO 9001/2000 e aproximadamente 6 mil funcionários em seu quadro de colaboradores, a empresa exporta para mais de 26 países, com destaque para África do Sul, Portugal, Inglaterra e Estados Unidos.

O foco no design levou a Deca a conquistar importantes premiações como o IF Design Awards, de Hannover, Alemanha, por quatro anos consecutivos, além de ser presença constante no mais conceituado prêmio nacional, o Prêmio Design Museu da Casa Brasileira. A preocupação com o meio ambiente fez da Deca, em conjunto com outras empresas, membro fundador do GBC Brasil no ano de 2007, para auxiliar o desenvolvimento de produtos, processos e normas sustentáveis ligadas à construção civil. Foi a única do seu setor a ter esta iniciativa.

A Empresa ainda possui programas para reciclagem e reuso de água, o destaque pode ser dado para as unidades de louças que atingem 52% no reuso de água.



SUSTENTABILIDADE E CONFORTO

Para Deca, trabalho significa pensar no futuro.

Para a Deca, ser uma grande marca não é apenas criar produtos inovadores e de qualidade, é também ter consciência do impacto de cada atividade no meio ambiente, na sociedade, no planeta. E ter como uma das principais metas a construção de um futuro melhor.

É por isso que concentramos nossos esforços em ações voltadas à sustentabilidade, tema que devido à sua urgência e relevância, sempre esteve presente no dia-a-dia da organização. Além de investir em pesquisas para aprimorar seus processos de produção e produtividade com o uso racional de recursos naturais, de baixo impacto ambiental, apoia projetos de capacitação profissional, educação, tratamento de efluentes, gestão de resíduos e proteção e estudo da biodiversidade, entre outros.

A Deca investe constantemente no desenvolvimento de produtos economizadores para fins residenciais, comerciais, industriais e também para o setor público. São tecnologias diversas de acionamento automático, mecânico ou óptico e de restrição de vazão, todas gerando consumo consciente e significativa economia de água para o usuário.

LOUÇAS

10

Difícil acreditar que não foi feito só para você.

CUBAS

72

Soluções exclusivas para deixar seu projeto ainda mais seu.

METAIS

116

A combinação perfeita entre design e tecnologia.



BANHO

290

Para fazer do seu banho um momento único.

COMPLEMENTARES

324

A diferença nos pequenos detalhes.

ACESSIBILIDADE E HOTEL

338

Conforto e acessibilidade em qualquer espaço.

MONOCOMANDOS

236

Produtos de última geração para a sua casa.



FILTROS

256

Tecnologia a serviço do seu bem-estar.



COZINHA

262

Mais do que uma cozinha, um verdadeiro espaço gourmet.



ECONOMIZADORES

Economia como você quer, sustentabilidade como o planeta precisa.

362



BÁSICOS

Qualidade e tecnologia no produto que você confia.

396

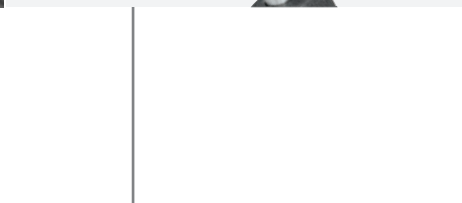

HYDRA

A solução na ponta dos dedos.

422



ÍCONES

LOUÇAS E CUBAS



MAIS ALTA



DUAL FLUX - 3 E 6 LITROS

METAIS E ECONOMIZADORES



1/8 DE VOLTA



ANTI VANDALISMO



1/4 DE VOLTA



ECONOMIZA ÁGUA



1/2 VOLTA

COZINHA



1/8 DE VOLTA



AREJADOR ARTICULADO



1/4 DE VOLTA



DUCHA, BICA MÓVEL



1/2 VOLTA

BANHO



JATO LINEAR



JATO TRADICIONAL + MASSAGEM



JATO MASSAGEM



JATO NEBULIZADOR



JATO TRADICIONAL



JATO TRADICIONAL + NEBULIZADOR



CRIVO ARTICULADO



06 LITROS POR MINUTO



12 LITROS POR MINUTO



CONTROLE DE ACIONAMENTO



CRIVOS SALIENTES
FACILITAM A LIMPEZA



SISTEMA AUTOLIMPANTE



TECNOLOGIA QUE MISTURA AR E ÁGUA



ECONOMIZA ÁGUA

HYDRA



DUPLO ACIONAMENTO



ECONOMIZA ÁGUA



ANTI VANDALISMO



SOFT TOUCH

OUTROS



LANÇAMENTO



LOCAIS DE UTILIZAÇÃO:
HOSPITAIS, CONSULTÓRIOS



DICAS DE INSTALAÇÃO



LOCAIS DE UTILIZAÇÃO:
BANHEIROS PÚBLICOS, EDIFÍCIOS COMERCIAIS



LOUÇAS

CUBO	13	STUDIO	39
DECA WISH	14	STUDIO KIDS	40
LK	15	MONTE CARLO	41
DREAM	17	SPOT	43
ASSENTO ELETRÔNICO CONFORTO	18	VILLAGE	45
PIANO	19	FAST	47
DK	20	RAVENA	48
WINDSOR	21	ASPEN	51
OXFORD	23	IZY	52
BELLE ÉPOQUE	25	MICTÓRIO SAVE	54
DUOMO PLUS	27	MICTÓRIOS	56
ONE PIECE	28	TANQUES	59
OMEGA	29	ACESSÓRIOS	61
CARRARA	30	COMPLEMENTARES	62
NUOVA	31	COMPLEMENTOS	64
DUNA	33	DICAS DE INSTALAÇÃO	66
QUADRA	34	ITENS DE INSTALAÇÃO	68
VOGUE PLUS	35	INFORMAÇÕES ÚTEIS	70

P.26C
bacia

P.26D
bacia

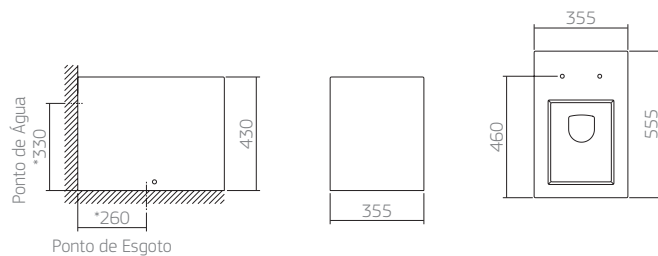

Bacia vendida junto com o assento, fixação e conector.

CD.26F
caixa acoplada
acionamento Dual flux

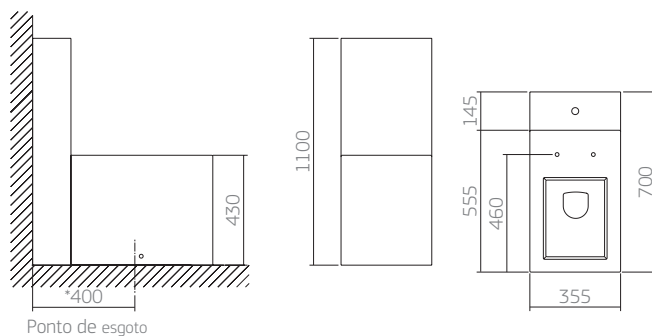

17 branco

95 ébano



Microban
proteção antibacteriana

Dimensões indicadas devem ser rigorosamente atendidas para uma perfeita instalação.

dimensões em milímetros

NOVO

P.280.17
bacia para caixa acoplada

CD.28F.17
caixa acoplada
acionamento Dual Flux



Bacia vendida junto com a fixação.

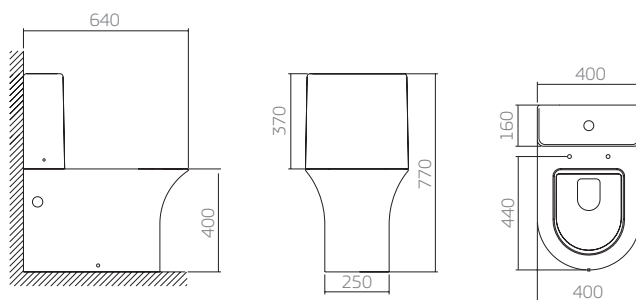

P.28.17
bacia convencional

Bacia vendida junto com a fixação.

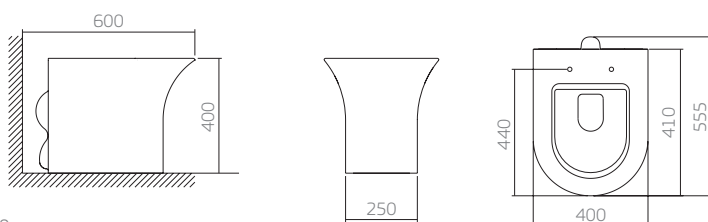

B.28.17
bidê 3 furos

Bidê vendido junto com a fixação.

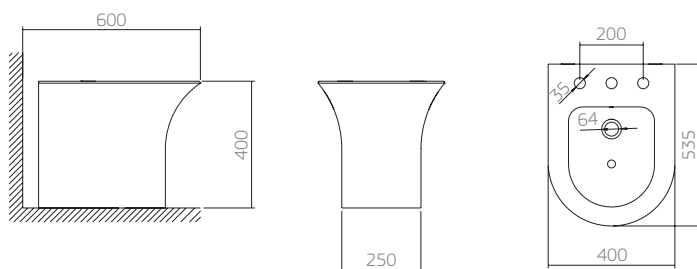

17 branco

95 ébano

AP.287 - assento poliéster slow close fixação cromada e dourada
AP.286 - assento termofixo slow close e easy clean

dimensões em milímetros

P.230
bacia para caixa acoplada

CD.23F
caixa acoplada
acionamento Dual flux

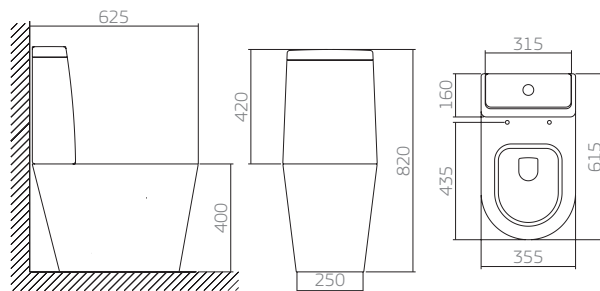

P.23
bacia convencional

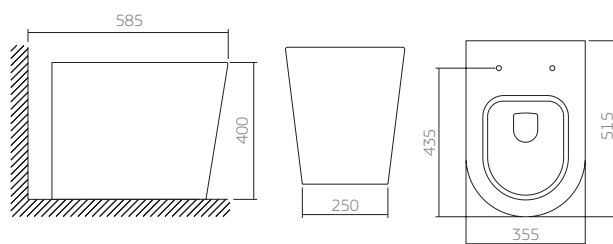

17 branco

94 ébano
fosco

95 ébano

22 marrom
fosco



Microban
proteção antibacteriana

AP.236 - assento termofixo slow close e easy clean

AP.237 - assento poliéster slow close

AP.60 - assento plástico

AP.23 - assento poliéster fixação cromada

AP.230 - assento poliéster fixação dourada

dimensões em milímetros

B.23
bidê (3 furos)

B.231
bidê (1 furo na mesa,
sem furo para ducha
vertical)

BV.231
bidê (1 furo na mesa,
com furo para ducha
vertical)

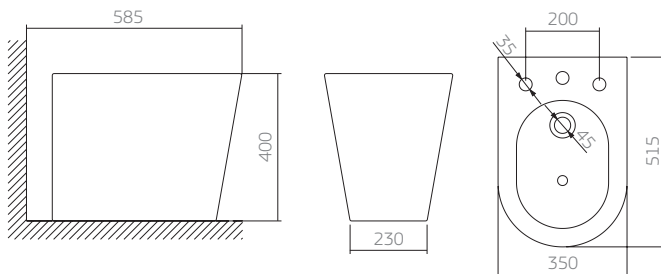

Os produtos B.231 e BV.231 estão disponíveis nas versão branco e ébano.

P.232
bacia convencional
suspensa

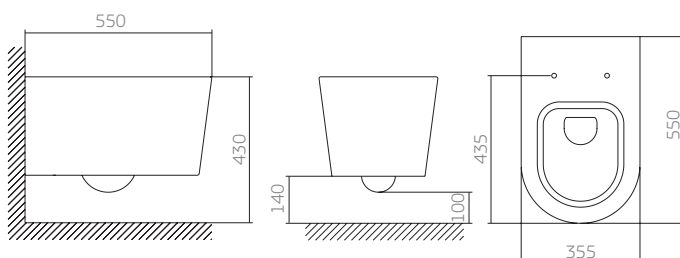

Disponível nas versões branco e ébano.

Somente instalar esta peça com suporte para bacia suspensa: alvenaria (SP.132.01), alvenaria com drywall (1100.SP.133.01) e drywall (1100.SP.133.01 com 1100.SP.134.01) - vendidos separadamente.

B.232
bidê (3 furos
suspensão)

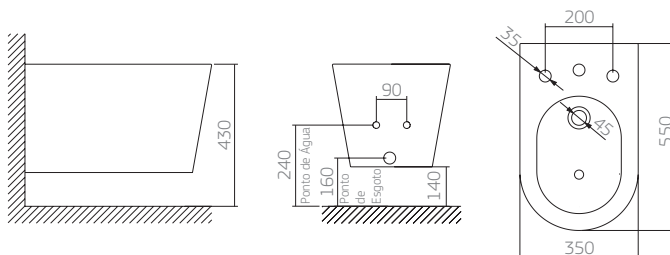

Disponível nas versões branco e ébano.

Somente instalar esta peça com suporte para bidê suspensão: alvenaria (SP.132.010) - vendido separadamente.

17 branco

94 ébano
fosco

95 ébano

22 marrom
fosco



AP.236 - assento termofixo slow close e easy clean

AP.237 - assento poliéster slow close

AP.60 - assento plástico

AP.23 - assento poliéster fixação cromada

AP.230 - assento poliéster fixação dourada

dimensões em milímetros

P.320C
bacia para
caixa acoplada

CD.32F
caixa
acoplada
acionamento
Dual flux

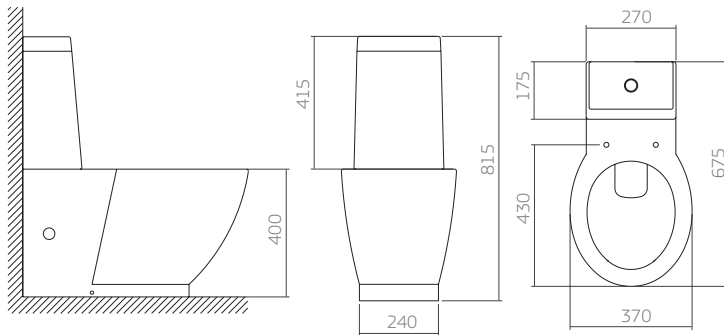

Bacia vendida junto com o assento e fixação.

P.32C
bacia convencional

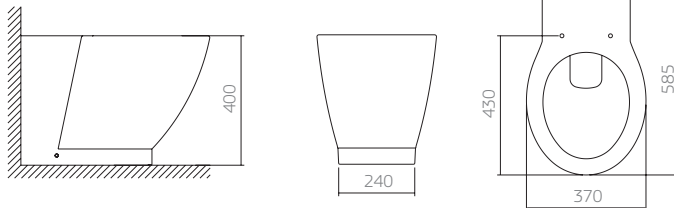

Bacia vendida junto com o assento e fixação.

B.32
bidê (3 furos)

B.321
bidê (1 furo na
mesa sem
furo para ducha
vertical)

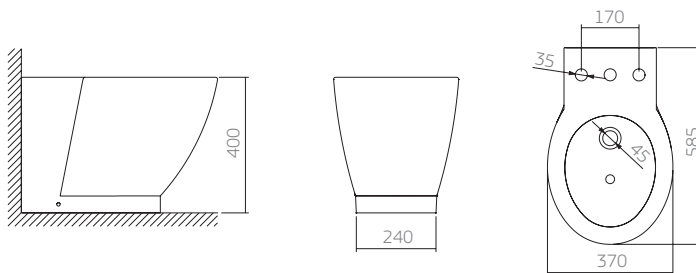

17 branco

95 ébano



Microban
proteção antibacteriana

dimensões em milímetros

ASSENTO ELETRÔNICO CONFORTO



ducha masculina e feminina



controle de posição da ducha



controle de temperatura de água e assento



controle pressão de água e ar



secagem com ar quente



auto limpeza



iluminação noturna com LED



programação de perfis

AP.1001 (110 V)
assento eletrônico

AP.1002 (220 V)
assento eletrônico

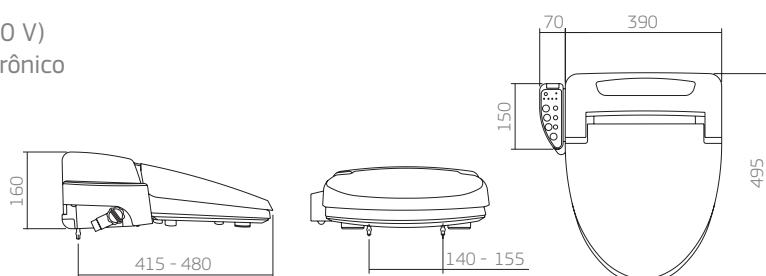

Prever ponto de energia que corresponda a voltagem do assento (110 v ou 220 v)
Pressão mínima de funcionamento 10 mca.

17 branco

dimensões em milímetros

18 LOUÇAS

P.330
bacia para caixa
acoplada

CD.21F
caixa acoplada
acionamento Dual
flux

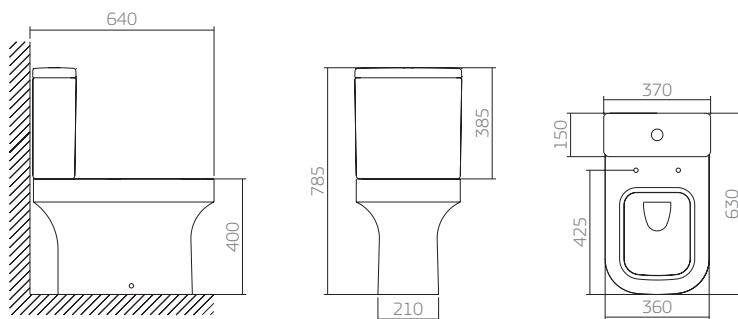

Bacia vendida junto com a fixação.

P.33
bacia
convencional

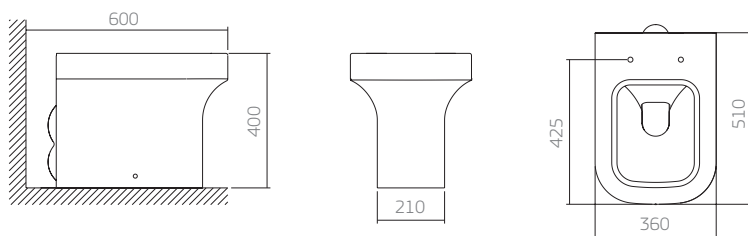

Bacia vendida junto com a fixação.

B.33
bidê (3 furos)

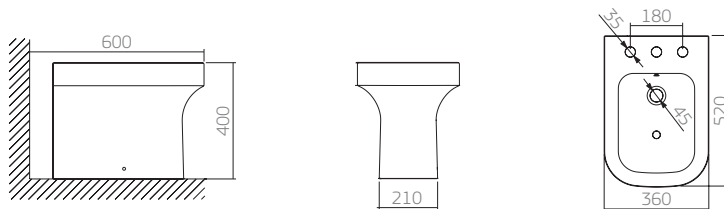

Bidê vendido junto com a fixação.

17 branco

94 ébano fosco

95 ébano

22 marrom fosco



AP.33 - assento poliéster fixação cromada
AP.330 - assento poliéster fixação dourada
AP.336 - assento termofixo slow close e easy clean
AP.337 - assento poliéster slow close

dimensões em milímetros

P.192
bacia convencional
suspensa

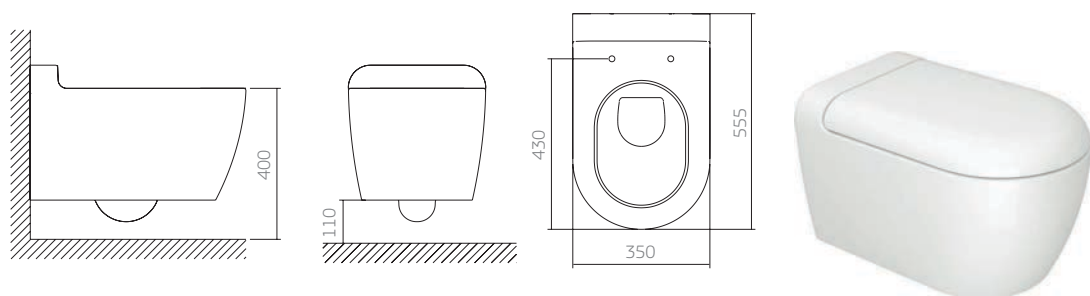

Somente instalar esta peça com suporte para bacia suspensa: alvenaria (SP.132.01), alvenaria com drywall (1100.SP.133.01) e drywall (1100.SP.133.01 com 1100.SP.134.01) - vendidos separadamente

B.192
bidê suspenso
(3 furos)

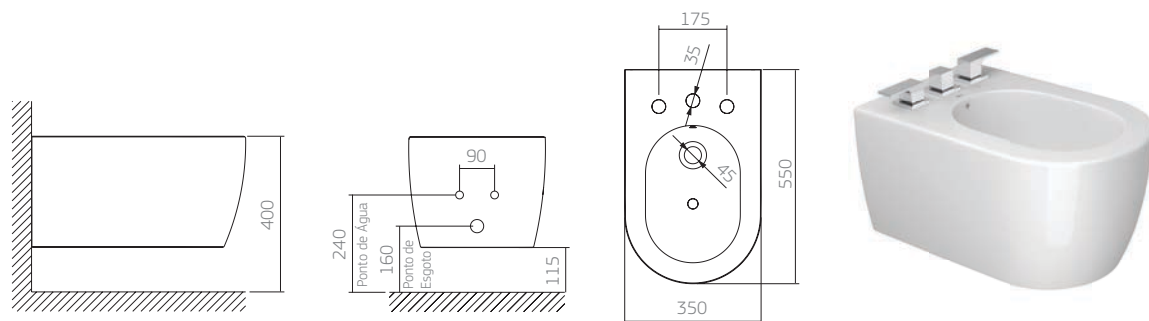

Somente instalar esta peça com suporte para bidê suspenso: alvenaria (SP.132.01) - vendido separadamente.

P.170
bacia para
caixa acoplada

CD.17F
caixa acoplada
acionamento
Dual flux

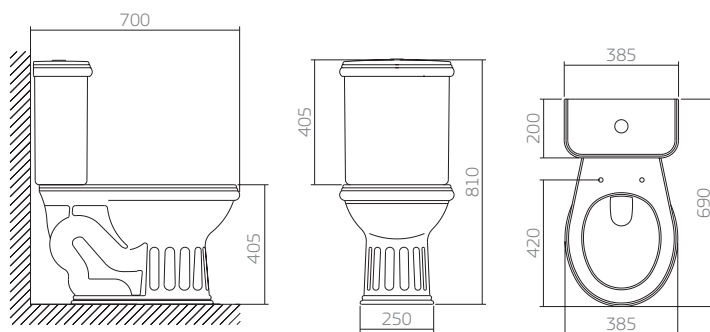

P.17
bacia
convencional

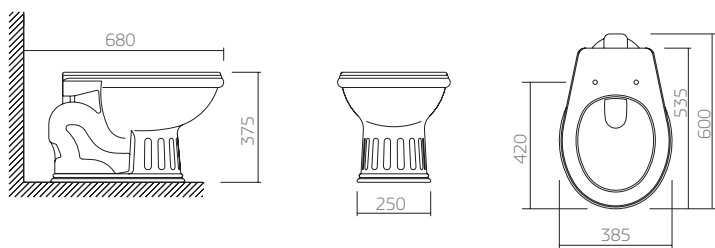

17 branco

37 creme

95 ébano



AP.17 - assento poliéster (fixação cromada)

AP.170 - assento poliéster (fixação dourada)

dimensões em milímetros

B.17
bidê (3 furos)

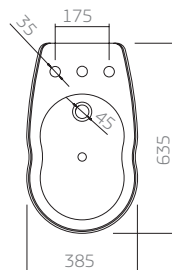
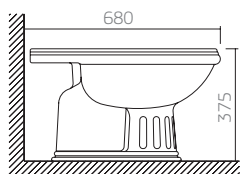

L.17 (lavatório grande)
L.171 (lavatório pequeno)
C.17 (coluna)
lavatório com coluna

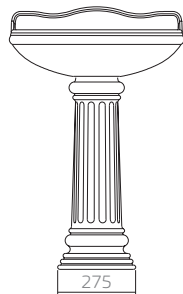
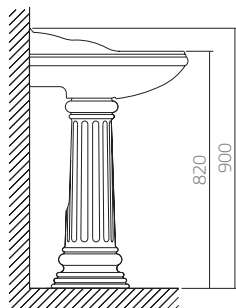

L.17

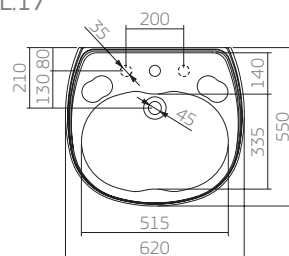

L.171

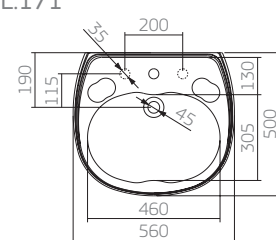

- 17 branco
- 37 creme
- 95 ébano

dimensões em milímetros

P.250
bacia para caixa acoplada

CD.25F
caixa acoplada
acionamento Dual flux

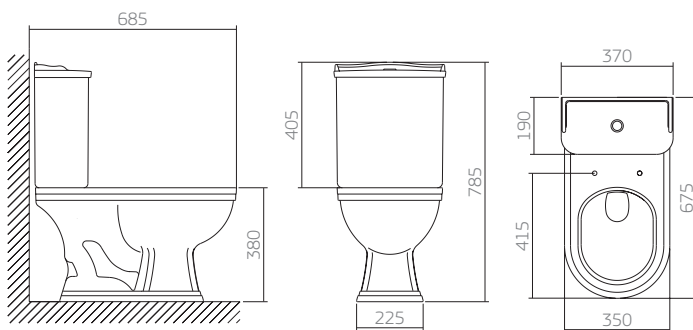

P.25
bacia convencional

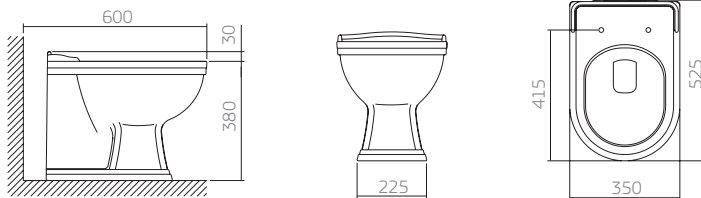

B.25
bidê (3 furos)

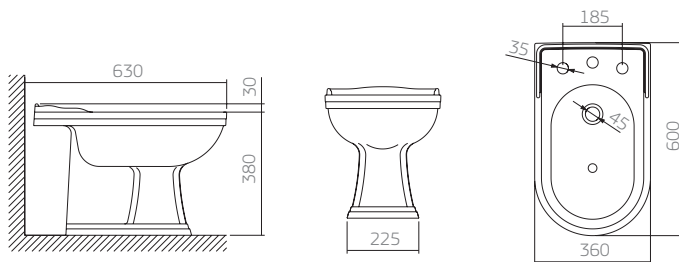

17 branco

37 creme

95 ébano



Microban®
proteção antibacteriana

AP.22 - assento poliéster (fixação cromada)
AP.220 - assento poliéster (fixação dourada)

dimensões em milímetros

L.25 (lavatório)
C.25 (coluna)
lavatório com coluna

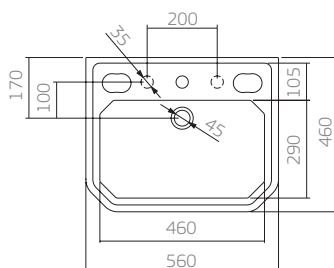
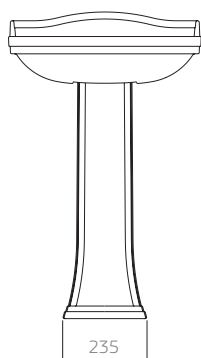
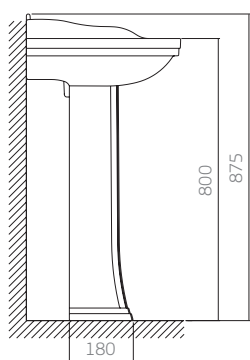

L.200
lavatório suspenso

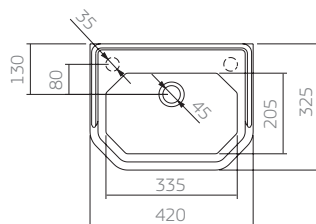
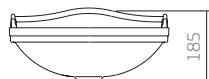
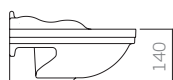

- 17 branco
- 37 creme
- 95 ébano

dimensões em milímetros

P.202
bacia para caixa
acoplada

CD.22F
caixa acoplada
acionamento
Dual flux

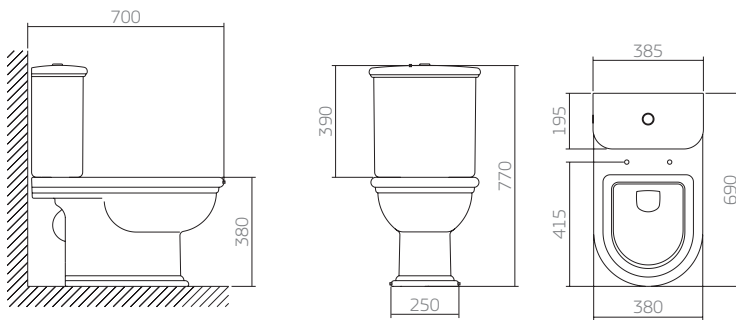

P.2
bacia
convencional

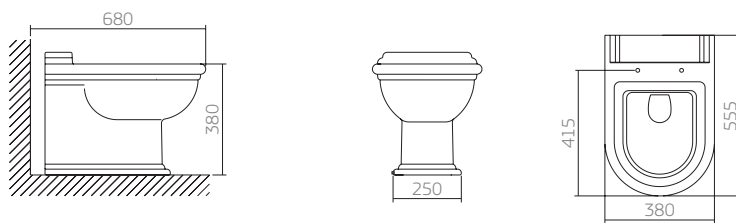

17 branco

37 creme

95 ébano



AP.22 - assento poliéster (fixação cromada)
AP.220 - assento poliéster (fixação dourada)

dimensões em milímetros

B.2
bidê (3 furos)

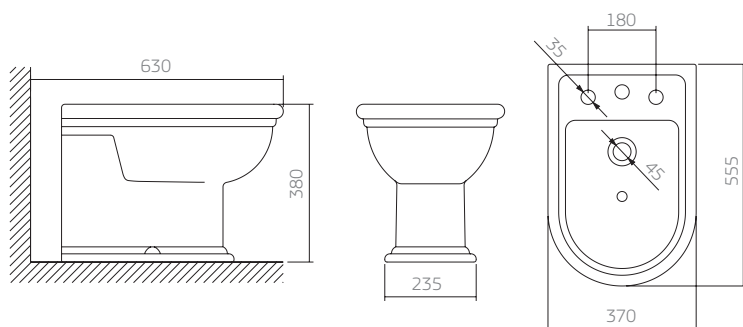

L.2 (lavatório)
C.2 (coluna)
lavatório com coluna

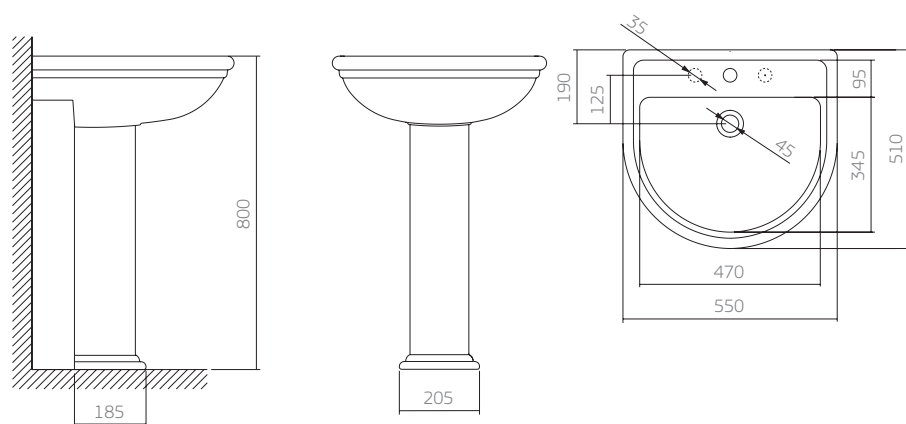

- 17 branco
- 37 creme
- 95 ébano

dimensões em milímetros

P.120
bacia para
caixa acoplada

CD.12F
caixa acoplada
acionamento
Dual flux

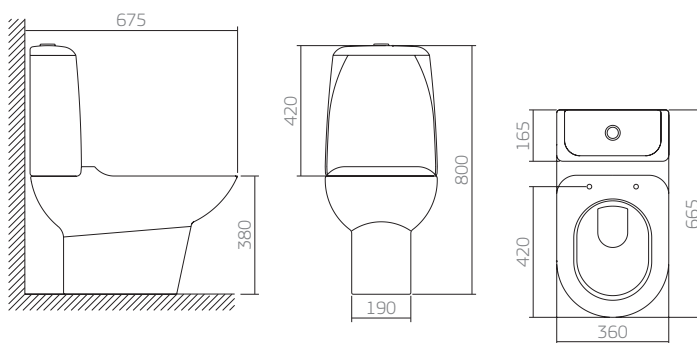

P.12
bacia
convencional

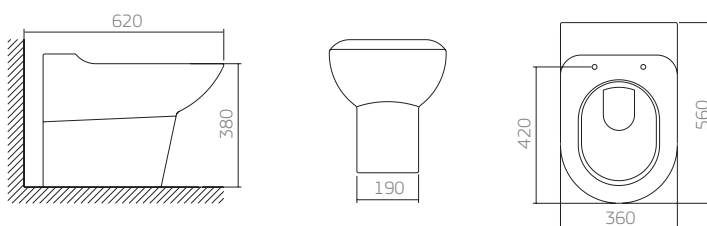

P.122
bacia
convencional
suspensa

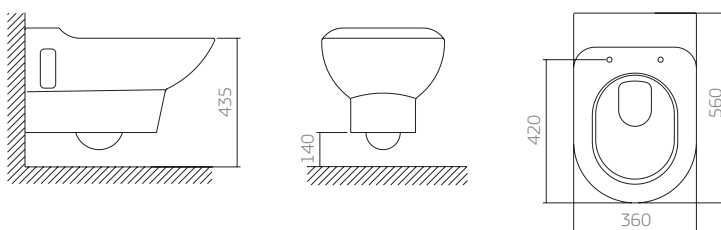

Somente instalar esta peça com suporte para bacia suspensa: alvenaria (SP.132.01), alvenaria com drywall (1100.SP.133.01) e drywall (1100.SP.133.01 com 1100.SP.134.01) - vendido separadamente.

B.12
bidê (3 furos)

B.121
bidê (1 furo na mesa,
sem furo para ducha
vertical)

BV.121
bidê (1 furo na mesa,
com furo para ducha
vertical)

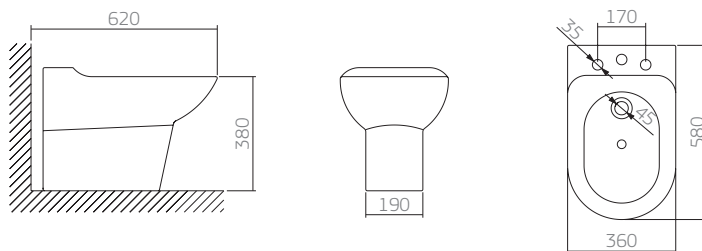

17 branco

37 creme

95 ébano



Microban
proteção antibacteriana

AP.121 - assento poliéster (fixação cromada)
AP.122 - assento poliéster (fixação dourada)
AP.123 - assento termofixo

dimensões em milímetros

P.143
bacia monobloco
e assento plástico slow close

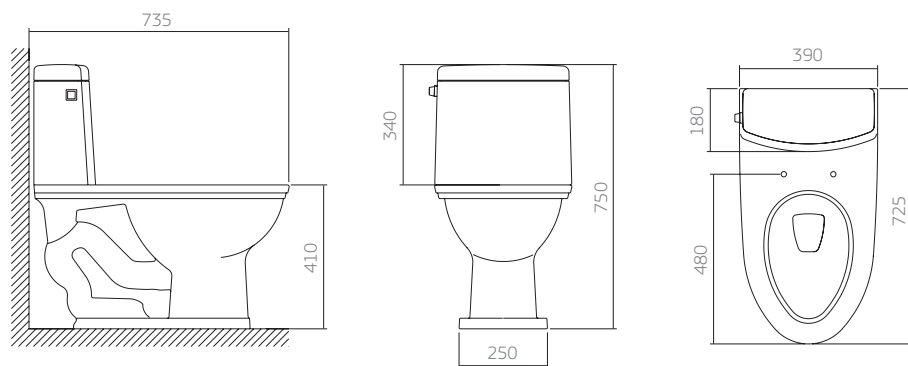

Bacia vendida com assento

17 branco

dimensões em milímetros

P.290
bacia para caixa acoplada

CD.09
caixa acoplada
acionamento convencional

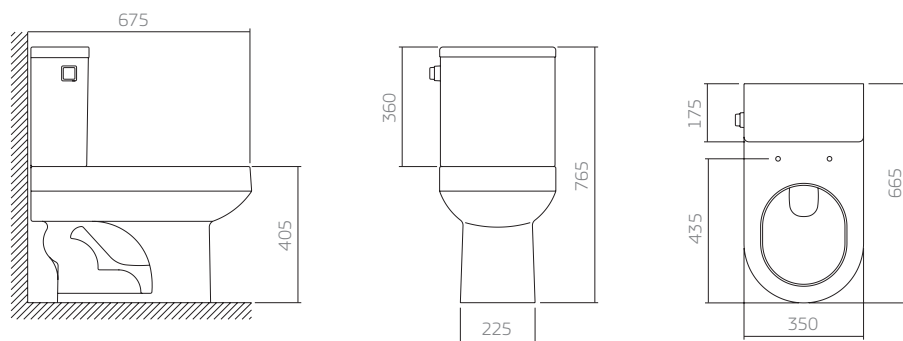

- 17 branco
- 95 ébano



- AP.23 - assento poliéster (fixação cromada)
- AP.230 - assento poliéster (fixação dourada)
- AP.236 - assento termofixo slow close e easy clean
- AP.237 - assento poliéster slow close

dimensões em milímetros

P.606
bacia para caixa
acoplada

CD.11F
caixa acoplada
acionamento Dual flux

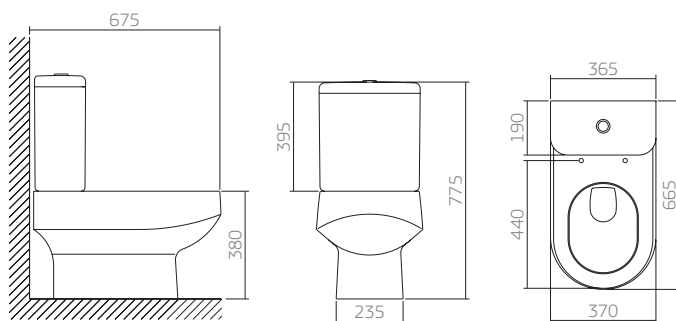

P.60
bacia convencional

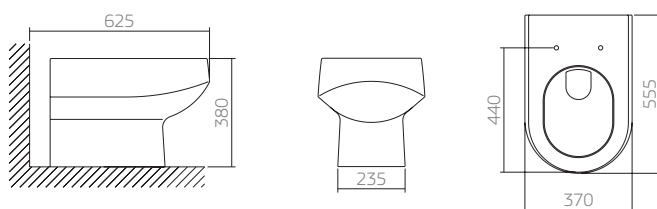

B.60
bidê (3 furos)

B.61
bidê (1 furo na mesa,
sem furo para ducha
vertical)

BV.61
bidê (1 furo na mesa,
com furo para ducha
vertical)

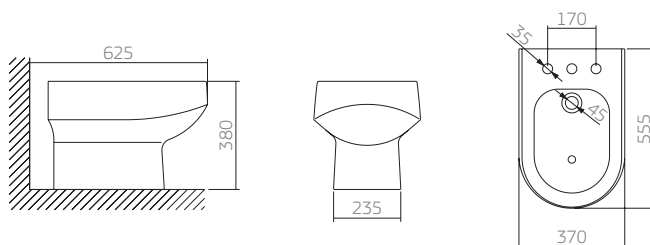

Os produtos B.61 e BV.61 estão disponíveis nas versões branco, creme e ébano.

17 branco

94 ébano
fosco

37 creme

95 ébano

22 marrom
fosco



AP.60 - assento plástico
AP.23 - assento poliéster (fixação cromada)
AP.230 - assento poliéster (fixação dourada)
AP.236 - assento termofixo slow close e easy clean
AP.237 - assento poliéster slow close

dimensões em milímetros

P.130
bacia para
caixa acoplada

CD.11F
caixa acoplada
acionamento dual flux

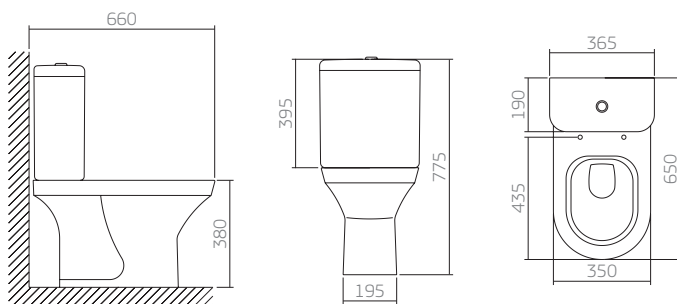

P.133*
bacia para
caixa acoplada
saída horizontal

CD.11F
caixa acoplada
acionamento dual flux

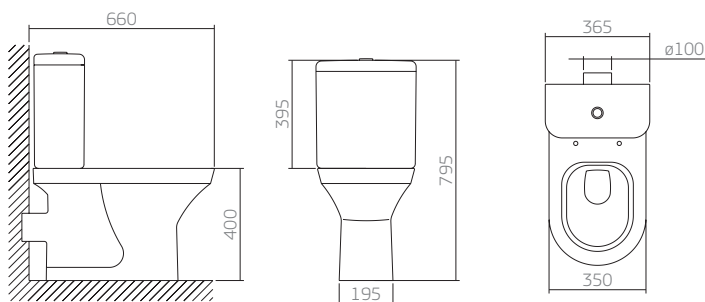

*Recomendamos utilizar canopla de acabamento CH.01

P.13
bacia convencional

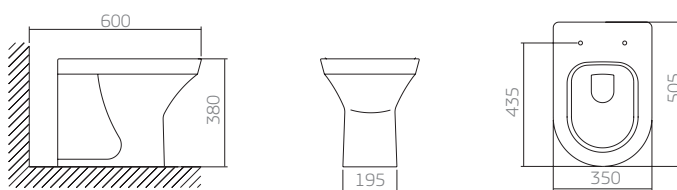

17 branco

95 ébano



- AP.60 - assento plástico
- AP.23 - assento poliéster (fixação cromada)
- AP.230 - assento poliéster (fixação dourada)
- AP.236 - assento termofixo slow close e easy clean
- AP.237 - assento poliéster slow close

dimensões em milímetros

P.131
bacia convencional
com saída horizontal

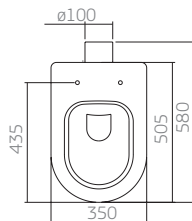
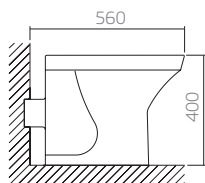

Recomendamos utilizar canopla de acabamento CH.01

B.13
bidê (3 furos)

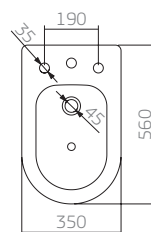
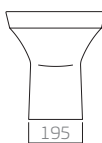
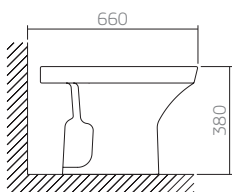

P.132
bacia suspensa

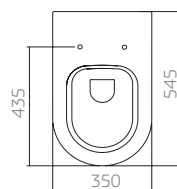
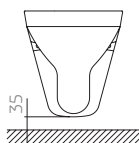
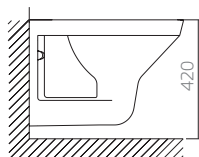

Somente instalar esta peça com suporte para bacia suspensa: alvenaria (SP.132.01), alvenaria com drywall (1100.SP.133.01) e drywall (1100.SP.133.01 com 1100.SP.134.01) - vendidos separadamente.

B.132
bidê suspenso

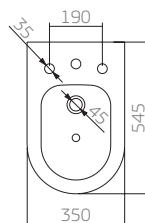
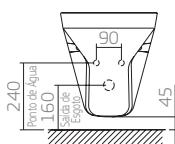
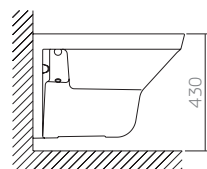

Somente instalar esta peça com suporte para bidê suspenso: alvenaria (SP.132.01) - vendido separadamente.

17 branco

95 ébano



- AP.60 - assento plástico
- AP.23 - assento poliéster (fixação cromada)
- AP.230 - assento poliéster (fixação dourada)
- AP.236 - assento termofixo slow close e easy clean
- AP.237 - assento poliéster slow close

dimensões em milímetros

P.707
bacia para
caixa acoplada

CD.01
caixa acoplada
acionamento
convencional

CD.01F
caixa acoplada
acionamento
Dual flux

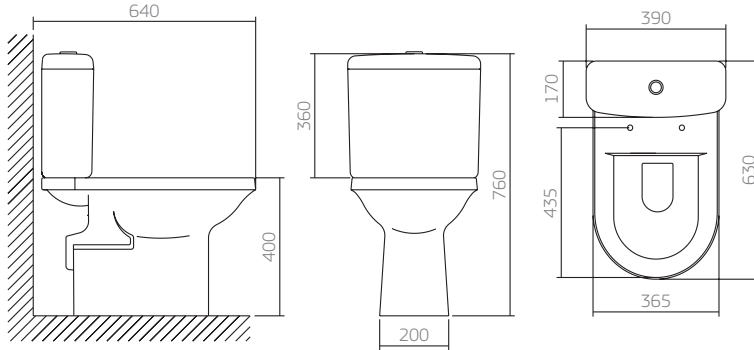

P.7
bacia convencional

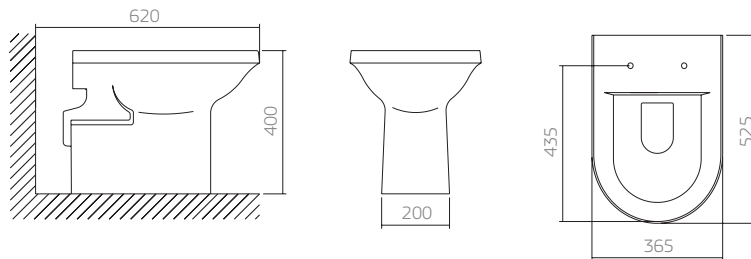

B.7
bidê (3 furos)

B.71
bidê (1 furo na
mesa, sem furo
para ducha vertical)

BV.71
bidê (1 furo na
mesa, com furo
para ducha vertical)

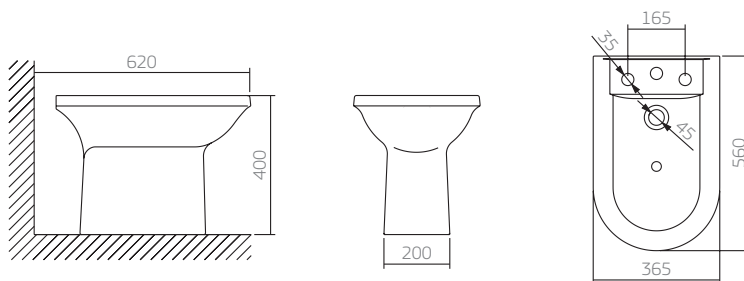

17 branco

37 creme



AP.60 - assento plástico
AP.23 - assento poliéster (fixação cromada)
AP.230 - assento poliéster (fixação dourada)
AP.236 - assento termofixo slow close e easy clean
AP.237 - assento poliéster slow close

dimensões em milímetros

P.210
bacia para caixa acoplada

CD.21F
caixa acoplada acionamento
Dual flux

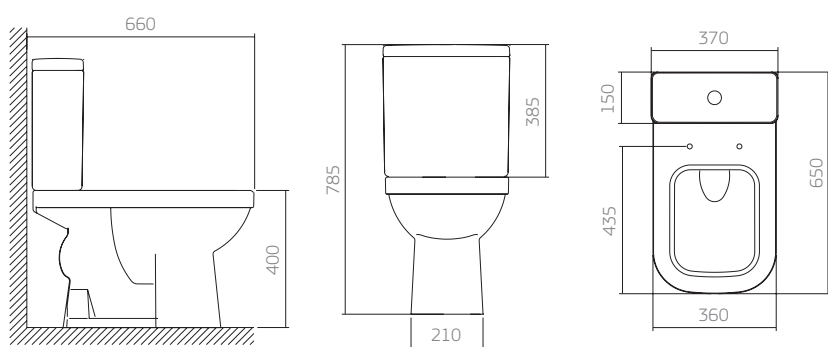

P.21
bacia convencional

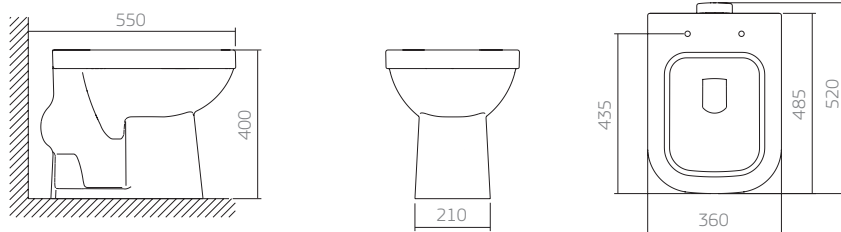

B.210
bidê (3 furos)

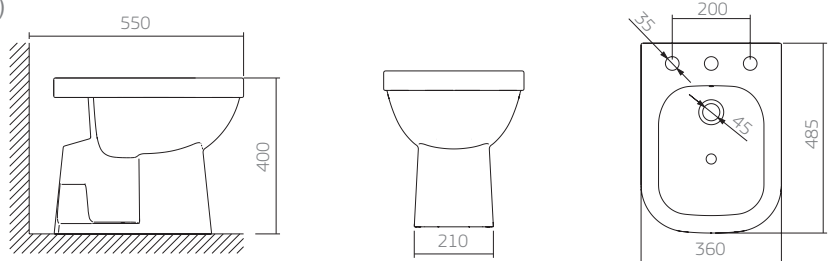

17 branco

37 creme

95 ébano



AP.215 - assento plástico slow close
AP.336 - assento termofixo slow close e easy clean
AP.21 - assento poliéster (fixação cromada)
AP.210 - assento poliéster (fixação dourada)

dimensões em milímetros

P.505
bacia para
caixa acoplada

CD.01
caixa acoplada
acionamento
convencional

CD.01F
caixa acoplada
acionamento Dual
flux

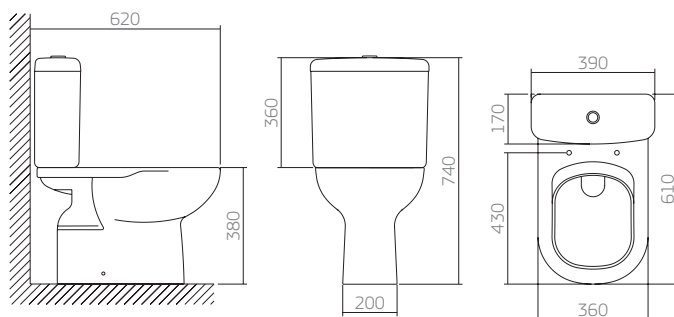

P.5
bacia convencional

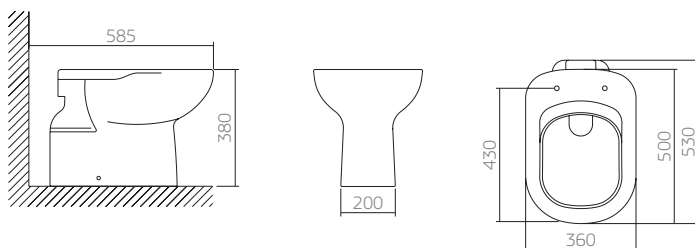

17 branco

37 creme

87 cinza



AP.50 - assento plástico

AP.52 - assento com abertura frontal (fixação cromada)

AP.516 - assento termofixo slow close e easy clean

AP.51 - assento poliéster (fixação cromada)

AP.510 - assento poliéster (fixação dourada)

AP.521 - assento com abertura frontal sem tampa

dimensões em milímetros

P.510
bacia convencional
linha conforto
sem abertura frontal

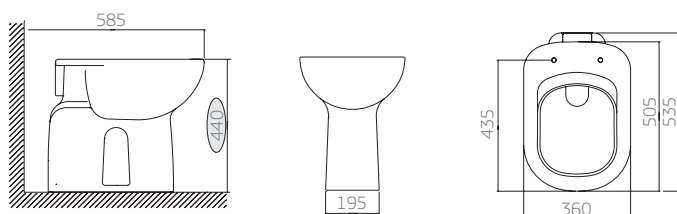

Produto fabricado somente na cor branco.

P.51
bacia convencional
linha conforto
com abertura frontal

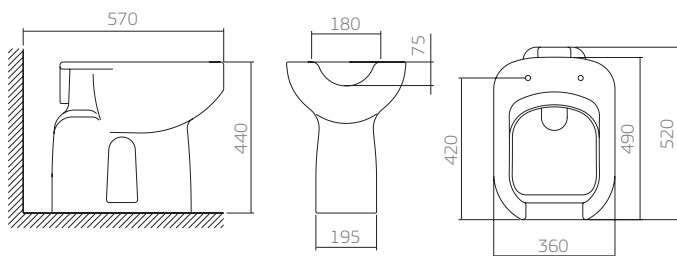

Recomendado para usuários que necessitem de auxílio em sua higienização.
Utilizar com assento AP.52 ou AP.521



- 17 branco
- 37 creme
- 87 cinza



dimensões em milímetros

- AP.50 - assento plástico
- AP.52 - assento com abertura frontal (fixação cromada)
- AP.516 - assento termofixo slow close e easy clean
- AP.51 - assento poliéster (fixação cromada)
- AP.510 - assento poliéster (fixação dourada)
- AP.521 - assento com abertura frontal sem tampa

B.5
bidê (3 furos)

B.51
bidê (1 furo na mesa,
sem furo para ducha
vertical)

BV.51
bidê (1 furo na mesa,
com furo para ducha
vertical)

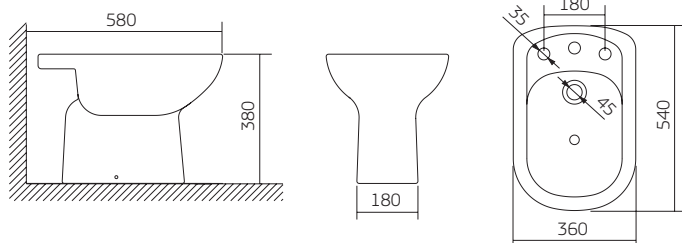

L.51
(lavatório)

C.1
(coluna)
lavatório com
coluna

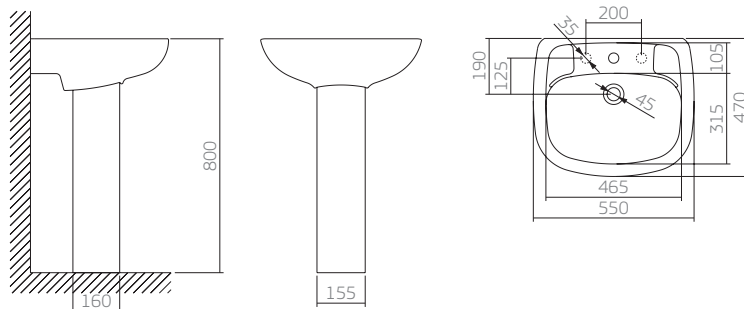

dimensões em milímetros

- 17 branco
- 37 creme
- 87 cinza

L.510
(lavatório)

C.510
(coluna suspensa)
lavatório pequeno
com coluna suspensa

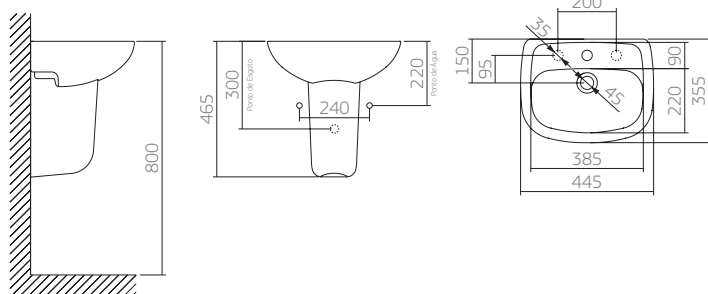

L.51
(lavatório)

CS.1
(coluna suspensa)
lavatório com
coluna suspensa

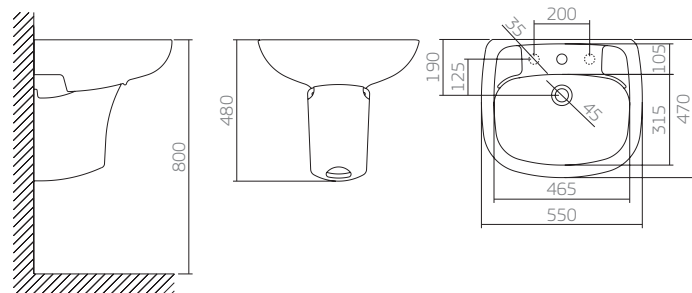

- 17 branco
- 37 creme
- 87 cinza



dimensões em milímetros

P.106
bacia para
caixa acoplada

CD.106
caixa acoplada
acionamento
convencional

CD.16F
caixa acoplada
acionamento Dual flux

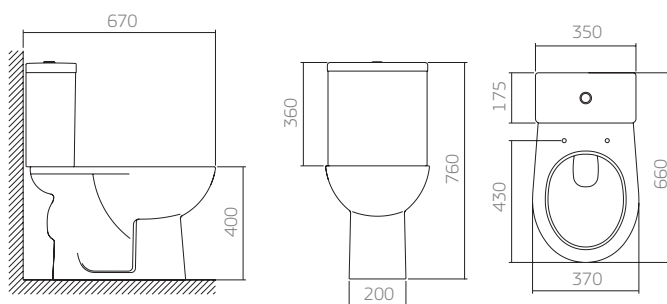

P.16
bacia convencional

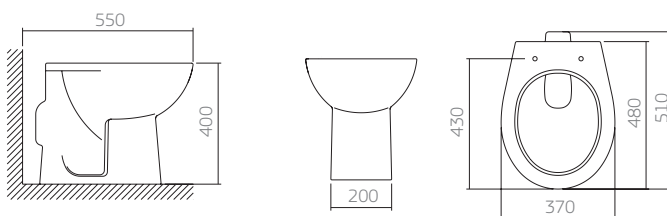

17 branco



Microban
proteção antibacteriana

AP.165 - assento plástico slow close
AP.01 - assento plástico com Microban

dimensões em milímetros

Caixa acoplada com sistema inovador de travamento da tampa, garantindo assim maior segurança para as crianças.

PI.106
bacia infantil para
caixa acoplada

CDS.00F
caixa acoplada
acionamento dual flux

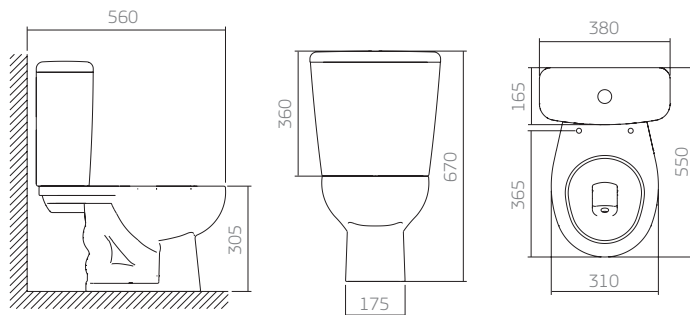

PI.16
bacia infantil
convencional

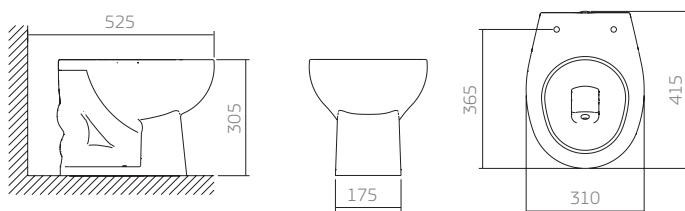

Conheça o tubo de ligação para bacia infantil

1968.C.KID / 1968.E.KID.BR
tubo de ligação para bacia infantil

Tubo de ligação para bacia infantil convencional: você instala a bacia ou troca por outro modelo Deca, sem quebrar nada.

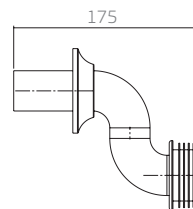
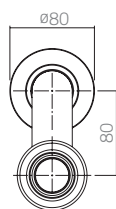

P.808
bacia para caixa
acoplada

CD.01
caixa acoplada
acionamento
convencional

CD.01F
caixa acoplada
acionamento Dual flux

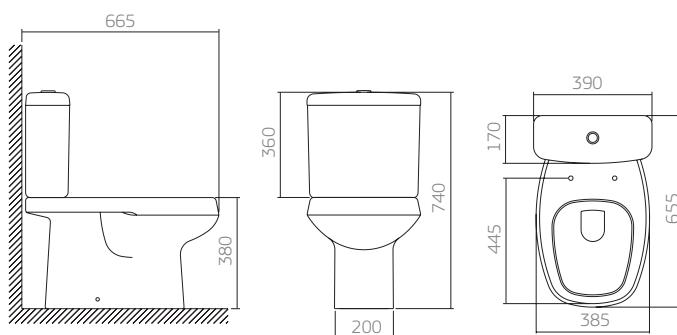

P.8
bacia convencional

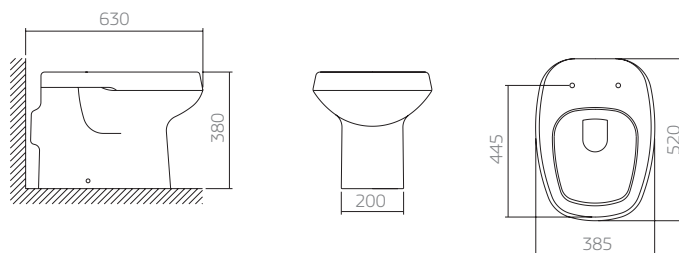

B.8
bidê (3 furos)

B.81
bidê (1 furo na mesa, sem
furo para ducha vertical)

BV.81
bidê (1 furo na mesa, com
furo para ducha vertical)

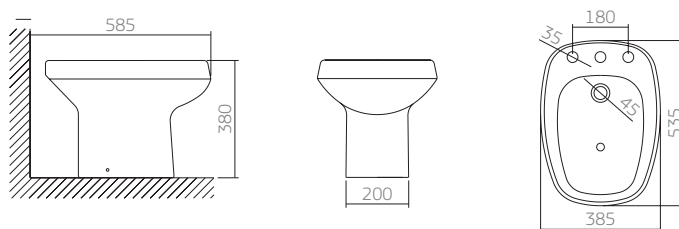

dimensões em milímetros

- | | | |
|------------------|-----------------|-----------------|
| 17 branco | 95 ébano | 37 creme |
| 51 azul | 60 verde | 87 cinza |



- AP.816 - assento termofixo slow close e easy clean
- AP.80 - assento plástico (exceto na cor ébano)
- AP.81 - assento poliéster (fixação cromada)
- AP.810 - assento poliéster (fixação dourada)

L.81
(lavatório)

C.1
(coluna)

lavatório com
coluna

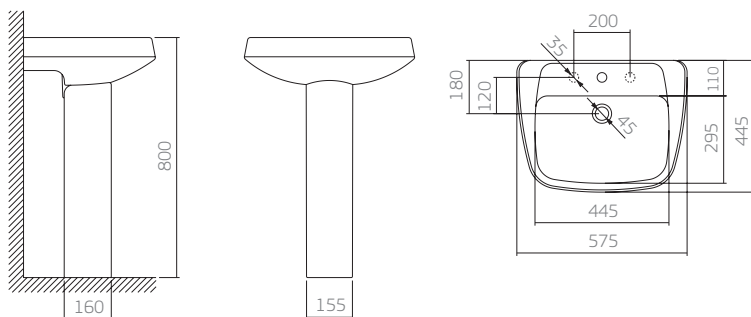

L.81
(lavatório)

CS.1
(coluna suspensa)

lavatório com
coluna suspensa

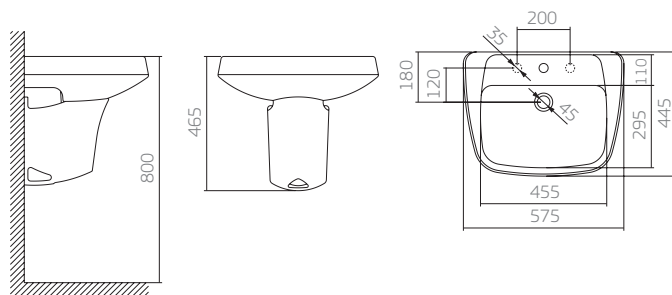

dimensões em milímetros

P.390
bacia para caixa
acoplada

CD.39
caixa acoplada
acionamento
convencional

CD.39F
caixa acoplada
acionamento
Dual flux

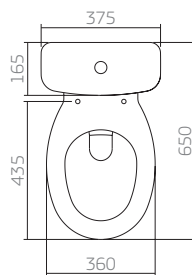
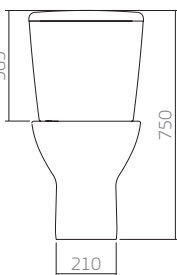
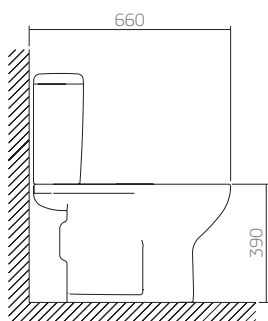

P.39
bacia convencional

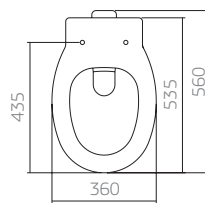
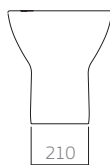
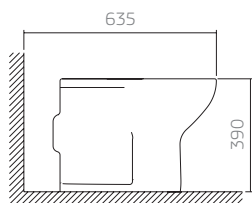

- 17 branco
- 37 creme
- 95 ébano

AP.394 - assento plástico slow close

dimensões em milímetros

L.39
(lavatório)

CS.39
(coluna suspensa)

lavatório com
coluna suspensa

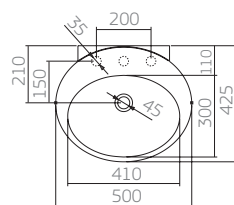
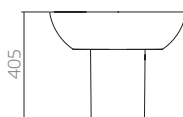
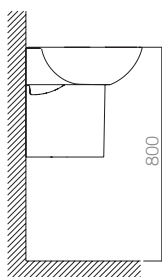

L.39
(lavatório de apoio)

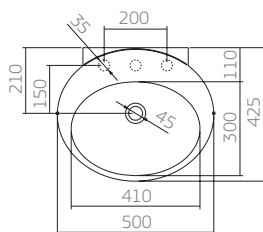

Pode ser utilizado como cuba de apoio.
Recomendamos encostar na parede devido a furação existente na parte traseira do lavatório.
Consulte um profissional especializado para instalar o lavatório como cuba de apoio.

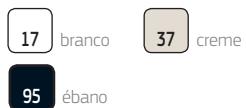

dimensões em milímetros

P.180
bacia para
caixa acoplada

CD.01
caixa acoplada
acionamento
convencional

CD.01F
caixa acoplada
acionamento Dual flux

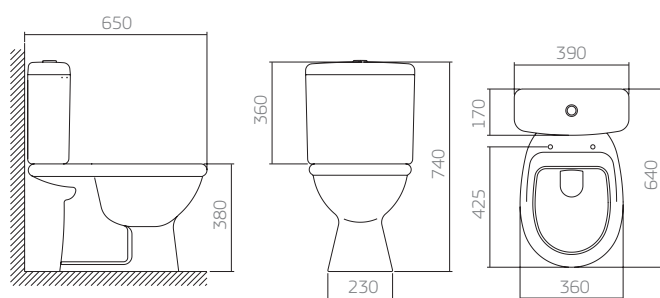

P.18
bacia convencional



B.18
bidê (3 furos)

BV.181
bidê (1 furo na mesa,
com furo para ducha
vertical)

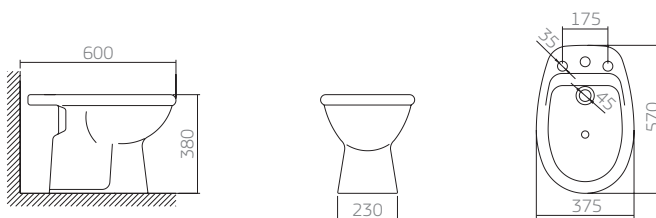

- 17 branco
- 37 creme
- 95 ébano
- 87 cinza



- AP.183 - assento termofixo
- AP.30 - assento plástico
- AP.18 - assento poliéster (fixação cromada)
- AP.180 - assento poliéster (fixação dourada)

dimensões em milímetros

L.18
(lavatório)

C.1
(coluna)

lavatório com coluna

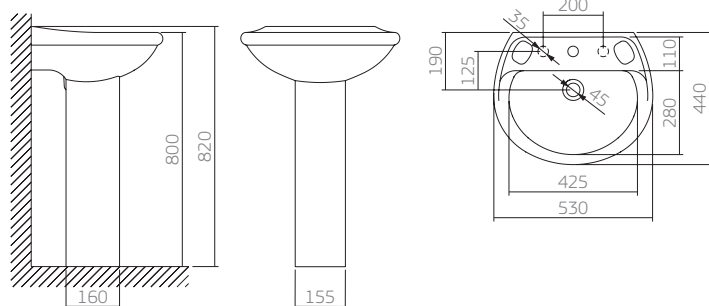

L.18
(lavatório)

CS.1
(coluna suspensa)

lavatório com
coluna suspensa

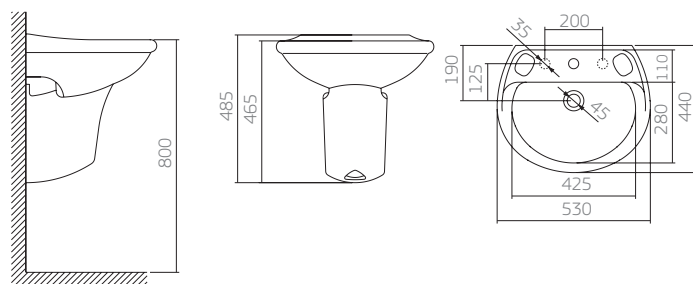

dimensões em milímetros

17 branco 37 creme

87 cinza

NOVO

P.76
bacia convencional

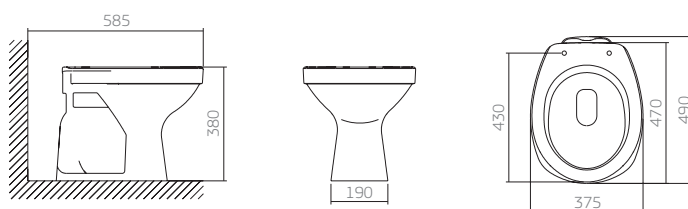

P.760
bacia para caixa
acoplada

CD.01
caixa acoplada
acionamento
convencional

CD.01F
caixa acoplada
acionamento Dual Flux

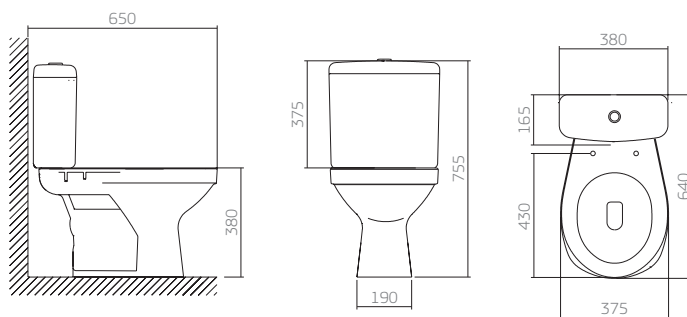

- 17 branco
- 95 ébano
- 37 creme
- 87 cinza



Microban
proteção antibacteriana

AP.75 - assento plástico com Microban

dimensões em milímetros

P.909
bacia para
caixa acoplada

CD.00
caixa acoplada
acionamento
convencional

CD.00F
caixa acoplada
acionamento
Dual flux

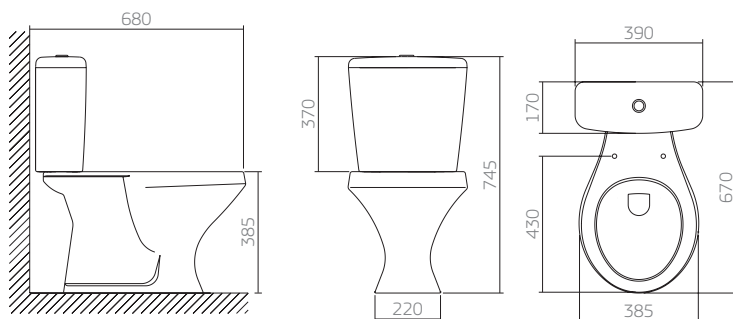

P.900
bacia para caixa
acoplada
saída horizontal

CD.00
caixa acoplada
acionamento
convencional

CD.00F
caixa acoplada
acionamento Dual flux

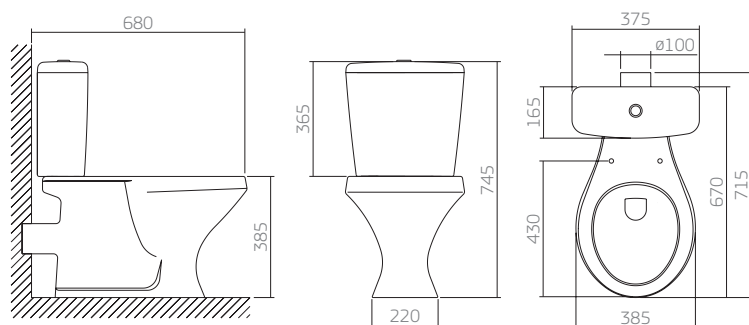

Recomendamos utilizar canopla de acabamento CH.01

P.9
bacia convencional

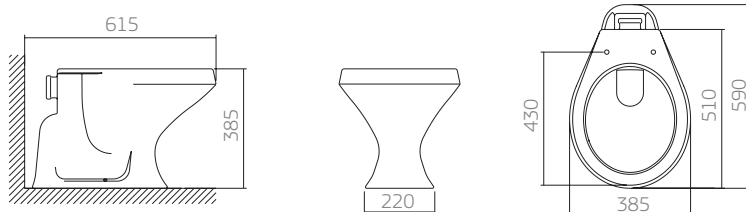

17	branco	95	ébano	37	creme	87	cinza
51	azul	60	verde	23	caramelo	89	rosa



AP.01 - assento plástico com Microban
AP.165 - assento plástico slow close (disponível na versão branco)

dimensões em milímetros

P.90
bacia
convencional
com saída
horizontal

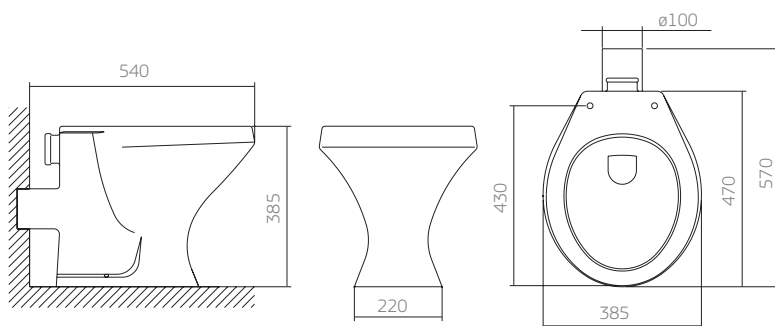

Recomendamos utilizar canopla de acabamento CH.01

B.9
bidê (3 furos)

B.91
bidê (1 furo
na mesa, sem
furo para ducha
vertical)

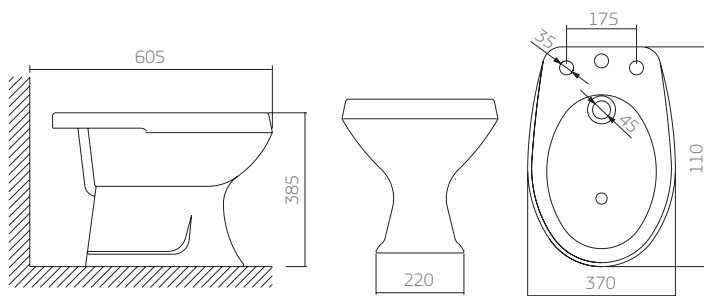

17	branco	95	ébano	37	creme	87	cinza
51	azul	60	verde	23	caramelo	89	rosa



Microban®
proteção antibacteriana

dimensões em milímetros

AP.01 - assento plástico com Microban
AP.165 - assento plástico slow close (disponível na versão branco)

L.91
(lavatório)

C.9
(coluna)

lavatório
com coluna

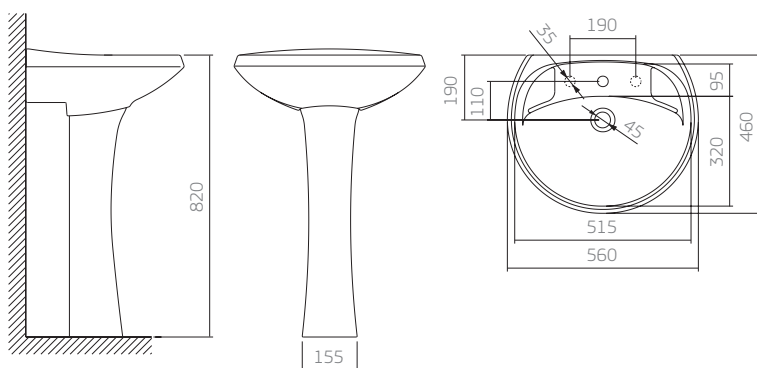

L.915
lavatório pequeno

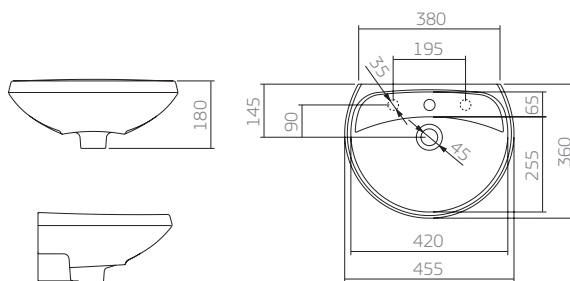

dimensões em milímetros

P.750
bacia para caixa
acoplada

CD.00
caixa acoplada
acionamento
convencional

CD.00F
caixa acoplada
acionamento Dual Flux

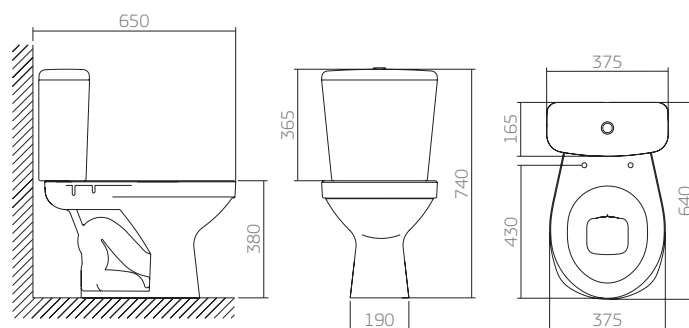

P.75
bacia convencional

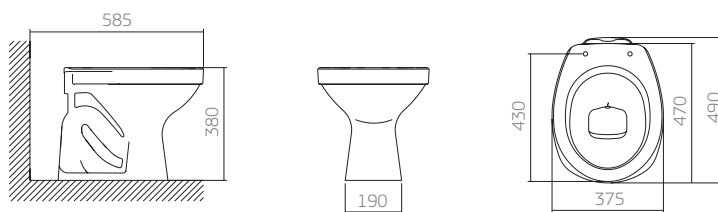

L.510
(lavatório)

C.10
(coluna)

lavatório com
coluna

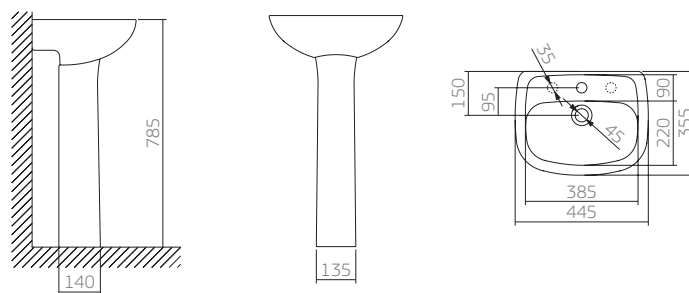

17	branco	95	ébano	37	creme	87	cinza
51	azul	60	verde	23	caramelo	89	rosa



AP.75 - assento plástico com Microban

dimensões em milímetros

P.111
bacia para
caixa acoplada

CD.00
caixa acoplada
acionamento
convencional

CD.00F
caixa acoplada
acionamento
Dual flux

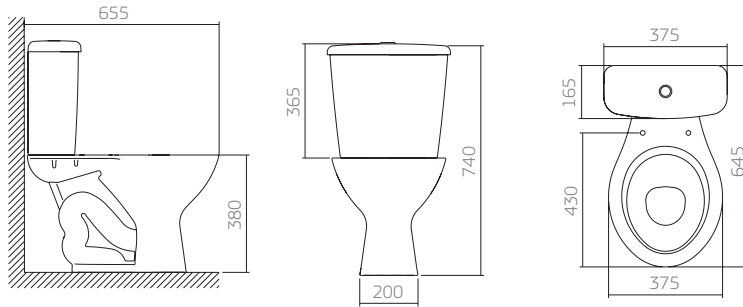

P.11
bacia convencional

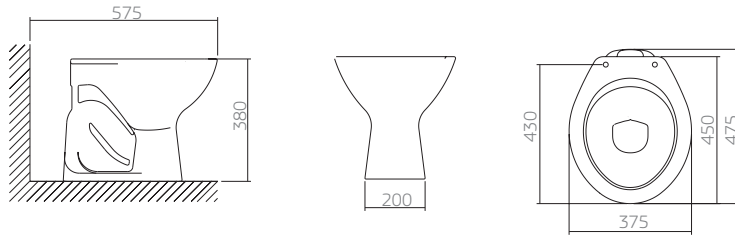

L.915
(lavatório)

C.10
(coluna)

lavatório com coluna

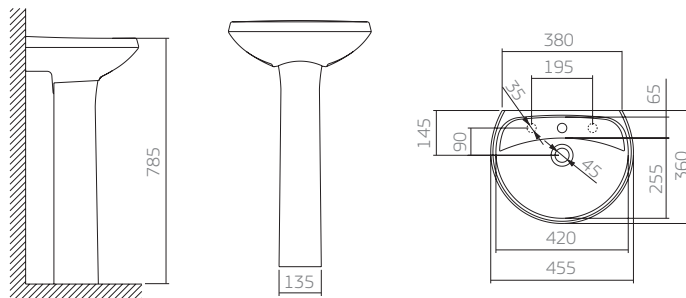

- 17 branco
- 37 creme
- 23 caramelo
- 87 cinza



AP.01 - assento plástico com Microban

AP.165 - assento plástico slow close (disponível na versão branco)

dimensões em milímetros

L.15
lavatório pequeno

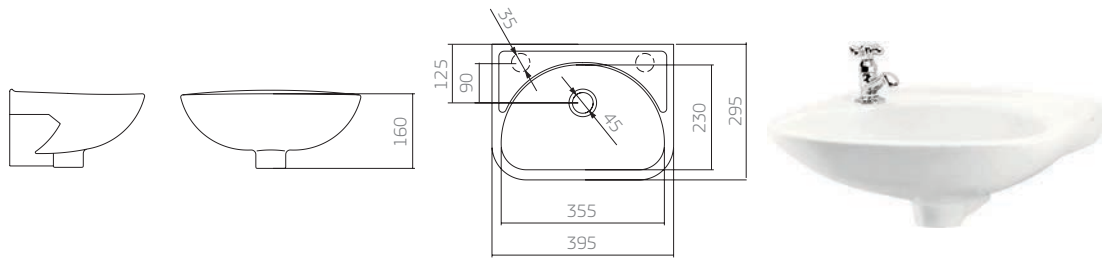

L.100
lavatório pequeno

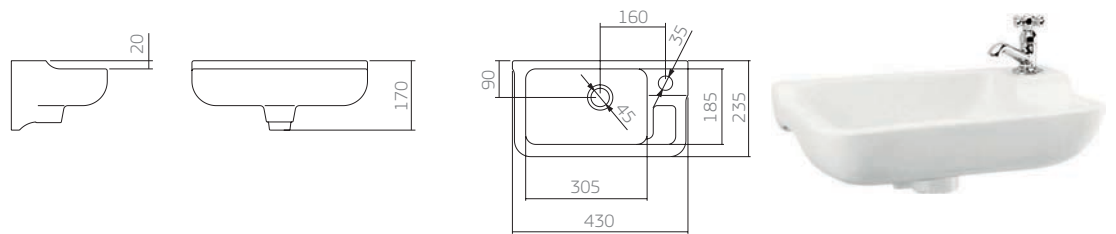

L.101
lavatório de canto

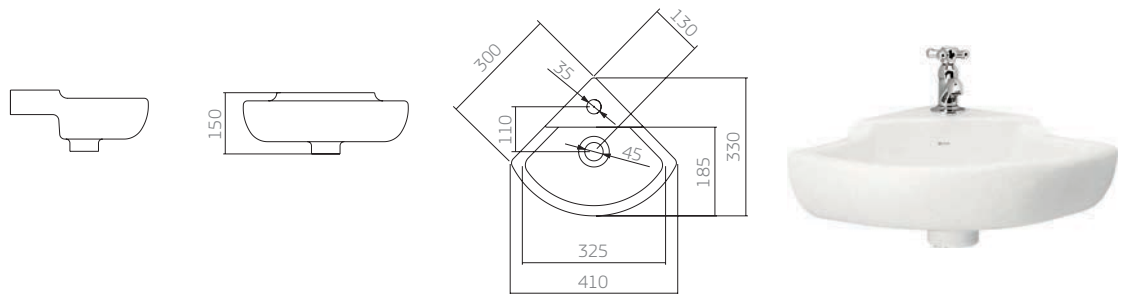

dimensões em milímetros

- 17 branco
- 37 creme
- 23 caramelo
- 87 cinza

MICTÓRIO SAVE DECA

Mictório Save Deca não necessita de água. É a solução econômica e ecológica para seu estabelecimento. É mais fácil e rápido de instalar, com ele você não precisa acrescentar pontos de água. O usuário não precisa apertar a descarga, ou seja, é mais higiênico e prático.

Veja por quê:

- Possui sistema interno de vedação por membrana.
- Ambiente higiênico: menor proliferação de bactérias.
- Não deixa odores: vedação por membrana que evita o retorno do mau cheiro
- Alta durabilidade: cartucho que dura 7.500 ciclos;
- Fácil higienização: o mictório deve ser **pulverizado** uma vez ao dia com solução de água e detergente com PH neutro e limpo com pano macio;

TECNOLOGIA QUE FAZ A DIFERENÇA

O anel superior tem as seguintes funções:

- Detergente: faz a limpeza da válvula e da tubulação.
- Desodorizador: mantém o ambiente livre de mau cheiro e perfumado, sem a necessidade de aplicação de outros produtos (ex: pastilhas, naftalina, limão e gelo).
- Sinalizador visual: aponta a hora certa de trocar. Quando o anel perde a cor, é o momento de trocar o refil.

Obs: o cartucho e a chave para troca acompanham os mictórios Save e Save Design.



Na parte interna você tem:

- Válvula com sistema interno de vedação por membrana: evita que o mau cheiro do esgoto retorne para o ambiente.

RECOMENDAÇÕES DE INSTALAÇÃO

Para uso confortável do mictório, são recomendadas as seguintes medidas de instalação:

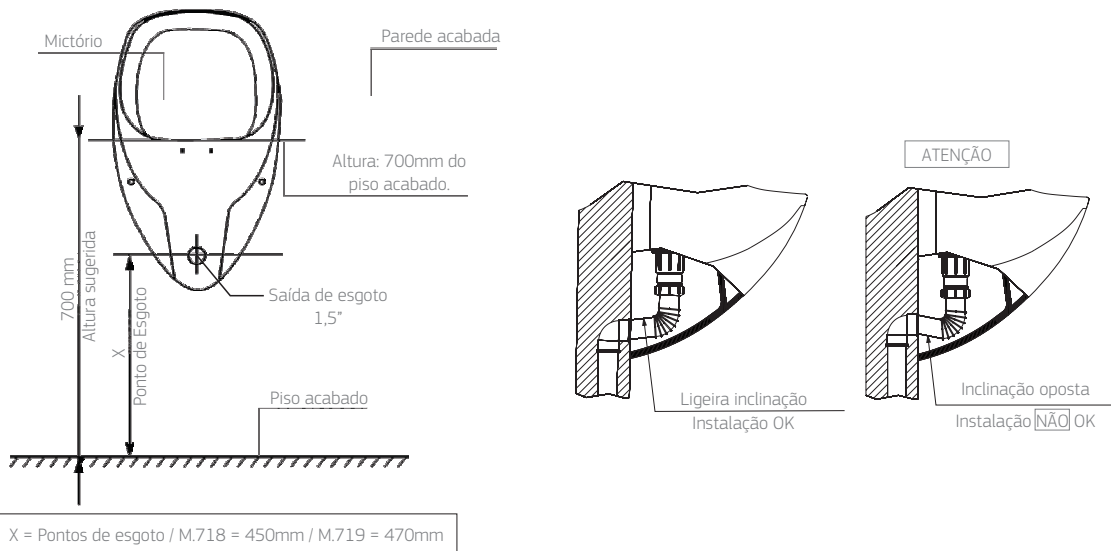

M.719
mictório com
sifão integrado

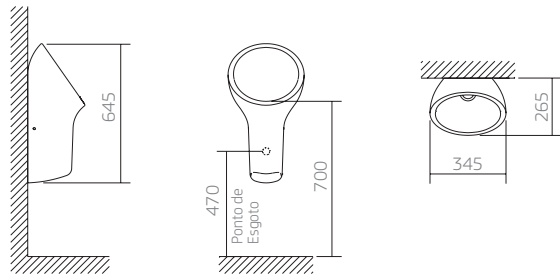

Acompanha fixação.

M.718
mictório com
sifão integrado

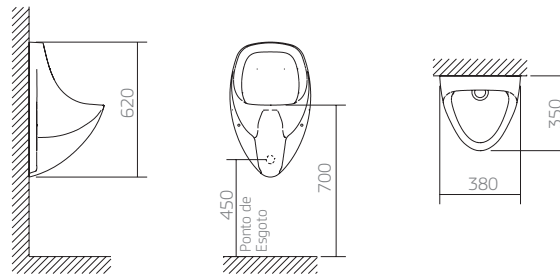

Utilizar SP.13 para fixação

SD.01.01
cartucho mictório save



dimensões em milímetros

M.716 mictório com sifão integrado

Disponível apenas na cor branco gelo
Utilizar FM.716 para instalação
Diâmetro de saída do esgoto = 1 ½"

17 branco

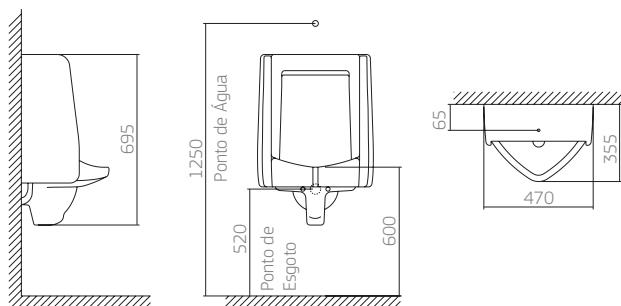

M.715 mictório com sifão integrado

17 branco

37 creme

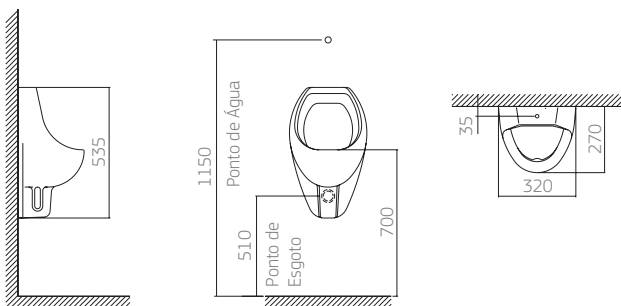

Utilizar FM.713 para instalação
Diâmetro de saída do esgoto = 1 ½"

dimensões em milímetros

M.714
mictório com sifão integrado
entrada de água embutida
(anti vandalismo)

Disponível apenas na cor branco gelo
Utilizar FM.714 para instalação
Utilizar com Decalux embutido 2780.C
Diâmetro de saída do esgoto = 1 ½"

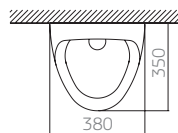
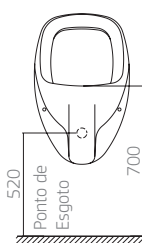
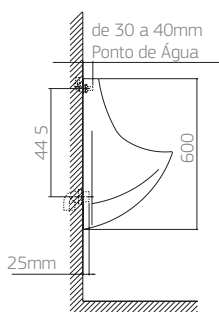

M.713
mictório com sifão integrado

Utilizar FM.713 para instalação
Diâmetro de saída do esgoto = 1 ½"

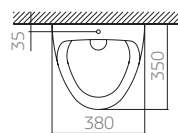
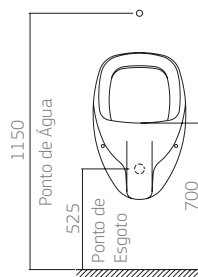
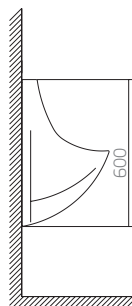

dimensões em milímetros

M.712 mictório com sifão integrado

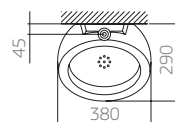
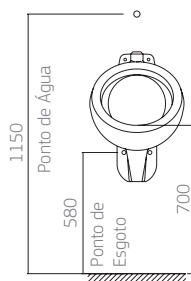
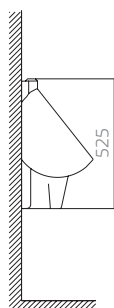

Utilizar FM.712 para instalação
Diâmetro de saída do esgoto = 2"

M.711 mictório

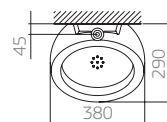
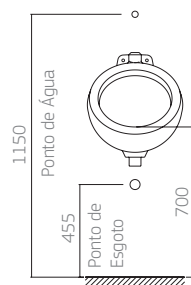
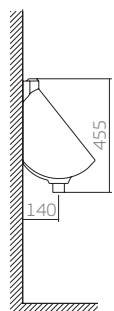

Utilizar com FM.711 para instalação
Diâmetro de saída do esgoto = 2"
Utilizar sifão 1681.C.100

17 branco

37 creme

dimensões em milímetros

TQ.01
tanque
capacidade total:
18 litros

CT.11
coluna para TQ.01

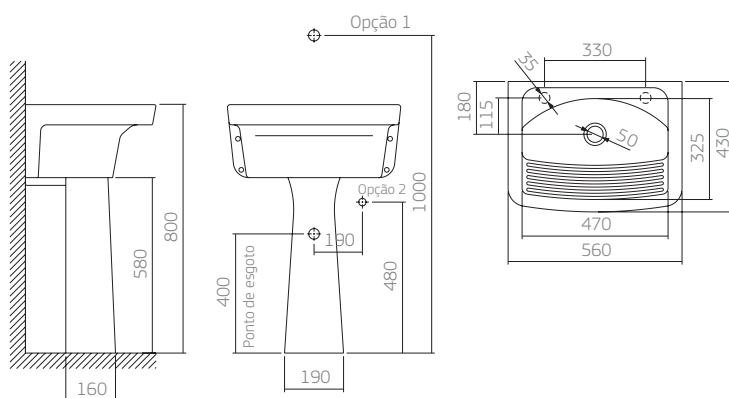

Utilizar válvula de escoamento 1606.C (1 ½ DN40)
Opção 1: para a instalação da torneira na parede.
Opção 2: para a instalação da torneira no tanque (esquerdo/direito)

TQ.02
tanque
capacidade total:
30 litros

CT.25
coluna para
TQ.02 e TQ.03

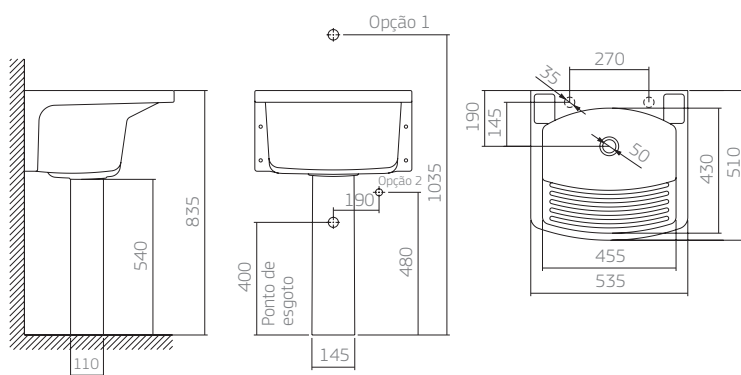

Utilizar válvula de escoamento 1606.C (1 ½ DN40)
Opção 1: para a instalação da torneira na parede.
Opção 2: para a instalação da torneira no tanque (esquerdo/direito)

- 17 branco
- 37 creme

Todos os modelos de tanques podem ser instalados sem a coluna.
Verifique qualidade da parede (ideal tijolo maciço, instalação sempre com FT.11)

dimensões em milímetros

TANQUES

TQ.03
tanque
capacidade total:
40 litros

CT.25
coluna para
TQ.02 e TQ.03

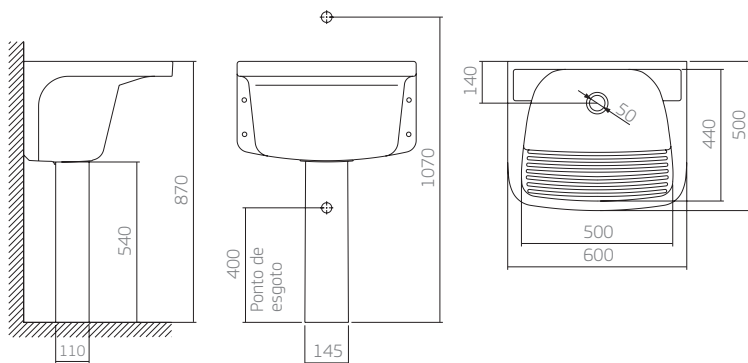

Utilizar válvula de escoamento 1606.C (1 ½ DN40)



17 branco

37 creme

Todos os modelos de tanques podem ser instalados sem a coluna.
Verifique qualidade da parede (ideal tijolo maciço, instalação sempre com FT.11)

dimensões em milímetros

A.180
saboneteira

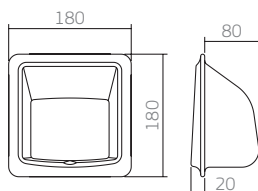

A.380
meia saboneteira

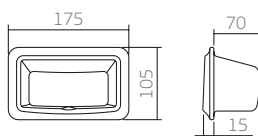

A.480
papeleira
(com rolete plástico)

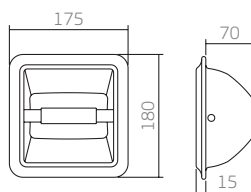

A.680
cabide

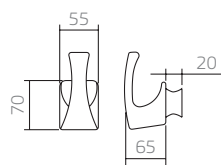

A.586
porta-toalha
(com bastão plástico)



- | | | | |
|------------------|--------------------|-----------------|-----------------|
| 17 branco | 95 ébano | 37 creme | 87 cinza |
| 60 verde | 23 caramelo | 89 rosa | |

Conjunto 3 peças CA.3.17 (A.380, A.480 e A.680)
Conjunto 5 peças CA.2.17 (A.180, A.380, A.480, A.586 e A.680)

dimensões em milímetros

1968.C
tubo de ligação com anel expansor para bacia disponível nas versões: Cromado, Branco, Bege, Dourado e Preto fosco.



1968.C.KID / 1968.E.KID.BR
tubo de ligação para bacia infantil



SP.13 (cromado)
SP.130 (dourado)
conjunto de fixação para bacia e bidê



SP.121
conjunto de fixação lateral para bacias



SP.7
conjunto de fixação para lavatório e coluna



FT.11
conjunto de fixação para tanque



1100.SP.134
opcional



SP.132
suporte para instalação de bacia e bidê suspensos em **alvenaria**



1100.SP.133
suporte para instalação para bacia em **drywall**



dimensões em milímetros

FM.711
conjunto de instalação para
mictório M.711



FM.712
conjunto de instalação para
mictório M.712



FM.713
conjunto de instalação para mictório
M.713 e M.715



FM.714
conjunto de instalação para
mictório M.714



FM.716
conjunto de instalação para
mictório M.716



4606.C
ligação flexível (30 e 40cm)
disponível nas versões” Cromado e
Dourado.



4607.C
ligação flexível malha de aço
(30 e 40cm)
Cromado



BS.5
conexão de entrada de água para
bacia convencional



CH.01
canopla para bacia com saída horizontal
P.90 / P.131 / P.133 / P.900



dimensões em milímetros

2553.C.114* / Deca Slim / DN 32 1 ¼" / ALTA E BAIXA PRESSÃO

2553.C.112* / Deca Slim / DN 40 1 ½" / ALTA E BAIXA PRESSÃO

Disponível nas versões cromado, preto fosco, dourado e gold.



2525.C.114*** / Hydra Retrô / DN 32 1 ¼" / ALTA PRESSÃO

2525.C.112*** / Hydra Retrô / DN 40 1 ½" / BAIXA PRESSÃO

É necessário utilizar com bacias de 6 litros.
Disponível nas versões cromado e dourado.



2555.C.114 / Hydra Plus / DN 32 1 ¼" / ALTA E BAIXA PRESSÃO

2555.C.112 / Hydra Plus / DN 40 1 ½" / ALTA E BAIXA PRESSÃO

Disponível nas versões cromado e dourado.



2545.C.114 / Hydra Duo / DN 32 1 ¼" / ALTA PRESSÃO

2545.C.112 / Hydra Duo / DN 40 1 ½" / BAIXA PRESSÃO

4900.C.DUO / acabamento Hydra Duo

Disponível nas versões com acabamento metálico: cromado e com acabamento em ABS: bege, cinza, branco e preto.



2565.C.114 / Hydra Eco / DN 32 1 ¼" / ALTA PRESSÃO

2565.C.112 / Hydra Eco / DN 40 1 ½" / BAIXA PRESSÃO

4900.C.ECO / Acabamento Hydra Eco

É necessário utilizar com bacias de 6 litros.
Disponível na versão cromado.



dimensões em milímetros

2590.C.114** / Hydra Clean / DN 32 1 ¼" / ALTA E BAIXA PRESSÃO

2590.C.112** / Hydra Clean / DN 40 1 ½" / ALTA E BAIXA PRESSÃO

4900.C.CLN / Acabamento Hydra Clean

Disponível nas versões com acabamento metálico: cromado, dourado e branco e com acabamento em ABS: branco, bege e cinza.



2550.C.114 / Hydra Max / DN 32 1 ¼" / ALTA E BAIXA PRESSÃO

2550.C.112 / Hydra Max / DN 40 1 ½" / ALTA E BAIXA PRESSÃO

4900.C.MAX / acabamento Hydra Max (cromado, branco, bege, cinza e dourado)

Disponível nas versões cromado, branco, bege, cinza e dourado.



2551.C.114 / Hydra Pro / DN 1 ¼" / ALTA E BAIXA PRESSÃO

2551.C.112 / Hydra Pro / DN 1 ½" / ALTA E BAIXA PRESSÃO

Disponível na versão cromado.



AV.90

DECANEL - anel de vedação com guia para bacias

- veda o mau cheiro do esgoto e dispensa o uso de bolsa plástica.
- anti-bacteriana.
- não resseca.
- não mancha o piso.



dimensões em milímetros

Sugestão de medidas para instalação de bidês

BIDÊS	
Linha	Ponto de Esgoto
Belle Époque	295
Carrara	255
Deca Wish	300
Duna	240
Duomo Plus	300
LK	255
Monte Carlo	265
Nuova	255
Oxford	250
Piano	285
Quadra	240
Ravena	210
Village	255
Vogue Plus	230
Windsor	275

Sugestão de medidas para instalação de lavatórios suspensos sem coluna

LAVATÓRIO SUSPENSO	
Produto	Ponto de Esgoto
L.915	330
L.15	310
L.100	300
L.101	280
L.200	290

Distância mínima entre bacia e bidê e da louça até a parede

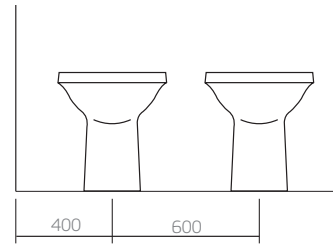

Sugestão de medidas para instalação da bacia Studio Kids (sem tubo de ligação para bacia infantil, com este tubo, manter pontos convencionais).

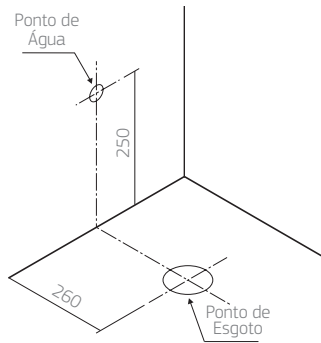

Sugestão de medidas para instalação de lavatórios suspensos sem coluna.

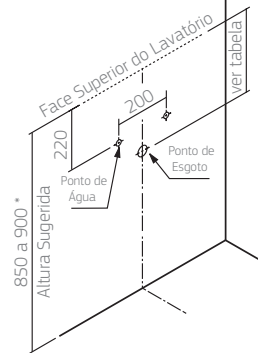

* Exceto PNE, que deve estar entre 780 a 800.

Sugestão de medidas para instalação de lavatórios com coluna suspensa (exceto L.510)

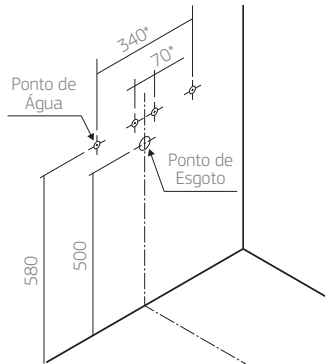

* Opções internas e externas para ponto de água, exceto L.510.

Sugestão de medidas para instalação de lavatórios com coluna

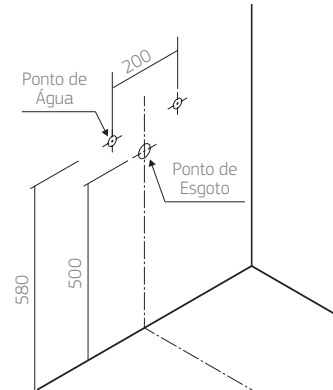

dimensões em milímetros

Sugestão de medidas para instalação de bacias com caixa acoplada (exceto linha cubo). Sugestão de medidas no folheto de instrução de instalação.

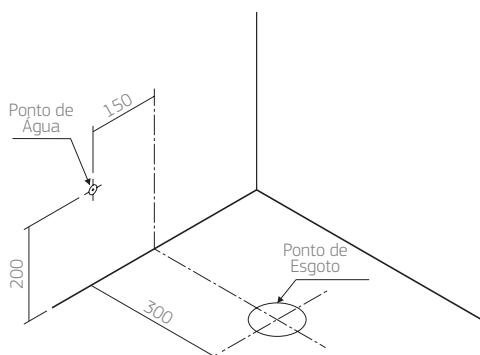

Sugestão de medidas para instalação de bacias convencionais.

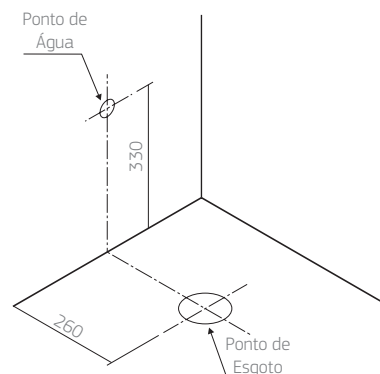

Sugestão de medidas para instalação de bidês. Dimensões válidas para os bidês de piso exceto B.32 - Bidê Dream. Verificar sugestão de medidas no folheto de instrução de instalação.

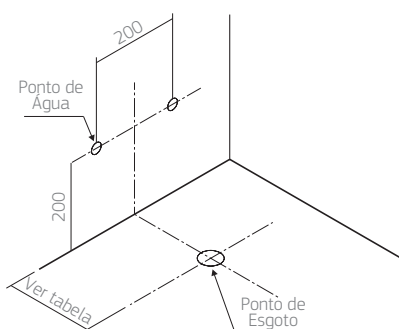

Sugestão de medidas para instalação de bacias com caixa acoplada com saída horizontal, apoiadas no piso.

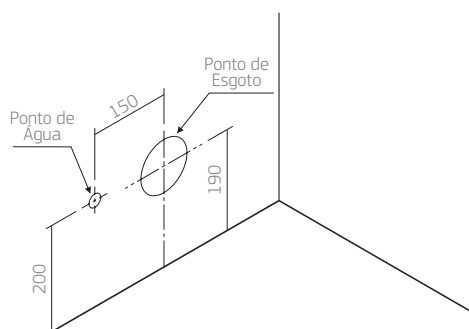

Sugestão de medidas para instalação de bacias convencionais com saída horizontal, apoiadas no piso ou suspensas.

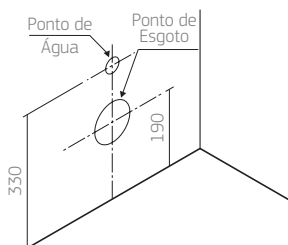

Sugestão de medidas para instalação de bidês suspensos.

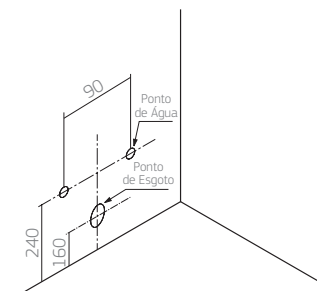

Para bacias suspensas somente instalar com o suporte de fixação:

- Em paredes de alvenaria usar o suporte código SP.132.
- Em paredes drywall usar os suportes código 1100.SP.133.01 e 1100.SP.134.01.

dimensões em milímetros

BACIA CONVENCIONAL

Linha	LK, Windsor, Oxford, Belle Époque, Duomo, Carrara, Nuova, Duna, Quadra, Studio, Studio Kids, Spot, Village, Fast, Ravena, Aspen, Izy, P.51, P.510	Vogue Plus*, Monte Carlo * Exceto P.51 e P.510	Deca Wish, Piano	Dream	Cubo
Fixação	SP.13.01 / SP.130.03	SP.121.01	Acompanha	Acompanha	Acompanha
Anel de Vedação	AV.90.01	AV.90.01	AV.90.01	AV.90.01	Acompanha
Tubo de Ligação	1968.C / BS.05.01	1968.C / BS.05.01	1968.C / BS.05.01	Acompanha conector	Acompanha conector

BACIA CONVENCIONAL COM SAÍDA HORIZONTAL

Linha	Nuova Ravena
Fixação	SP.13.01 SP.130.03
Tubo de Ligação	1968.C BS.05.01
Canopla	CH.01

BACIA COM CAIXA

Linha	LK, Windsor, Oxford, Belle Époque, Duomo, One Piece, Omega, Carrara, Nuova, Duna, Quadra, Studio, Studio Kids, Spot, Village, Fast, Ravena, Aspen, Izy	Vogue Plus, Monte Carlo	Deca Wish, Dream, Piano	Cubo
Fixação	SP.13.01 / SP.130.03	SP.121.01	Acompanha	Acompanha
Anel de Vedação	AV.90.01	AV.90.01	AV.90.01	Acompanha
Flexível	4607.C / 4606.C	4607.C / 4606.C	4607.C / 4606.C	Acompanha

BACIA COM CAIXA COM SAÍDA HORIZONTAL

Linha	Nuova Ravena
Fixação	SP.13.01 SP.130.03
Flexível	4607.C 4606.C
Canopla	CH.01

BACIA SUSPENSA

Linha	LK, DK, Duomo Plus, Nuova
Fixação	SP.132.01 / 1100.SP.133.01 / 1100.SP.134.01
Tubo de Ligação	1968.C / BS.05.01

BIDÊ SUSPENSO

Linha	LK, DK, Nuova
Fixação	SP.132.01*
Válvula de Escoamento	1601.C / 1601.C.CLI 1602.C / 1602.C.PLA

* somente em parede de alvenaria

dimensões em milímetros

BIDÊ

Linha	LK, Windsor, Oxford, Belle Époque, Duomo, Carrara, Nuova, Duna, Quadra, Village, Ravena	Vogue Plus, Monte Carlo	Deca Wish, Dream, Piano
Fixação	SP.13.01 / SP.130.03	SP.121.01	Acompanha
Válvula de Escoamento	1601.C / 1601.C.CLI / 1602.C / 1602C.PLA	1601.C / 1601.C.CLI / 1602.C / 1602C.PLA	1601.C / 1601.C.CLI / 1602.C / 1602C.PLA
Flexível*	4607.C / 4606.C	4607.C / 4606.C	4607.C / 4606.C

* para flexível de 40cm verifique posição dos pontos de alimentação

LAVATÓRIO COM COLUNA

Linha	Windsor, Oxford, Belle Époque, Vogue Plus, Monte Carlo, Village, Ravena, Aspen, Izy
Fixação	SP.7.01
Sifão	1684.C.100.112 / 1685.C.100.112 / 1680.C.100.112 / 1682.C.100.112
Válvula de Escoamento	1601.C / 1601.C.CLI / 1602.C.PLA / 1602.C

LAVATÓRIO SUSPENSO

Linha	Oxford, Ravena, Izy
Fixação	SP.9.01
Válvula de Escoamento	1601.C. 1601.C.CLI 1602.C.PLA 1602.C

LAVATÓRIO COM COLUNA SUSPensa

Linha	Vogue Plus, Spot, Village
Fixação	SP.9.01
Válvula de Escoamento	1601.C. 1601.C.CLI 1602.C.PLA 1602.C

MICTÓRIO

Linha	M.719	M.718	M.716	M.713 M.715	M.714	M.712	M.711
Fixação	Acompanha	SP.13.01 SP.130.03	FM.716.01	FM.713.01	FM.714.01	FM.712.01	FM.711.01
Sifão	Sifão Integrado	Sifão Integrado	Sifão Integrado	Sifão Integrado	Sifão Integrado	Sifão Integrado	1681.C.100

TANQUE

Linha	TQ.01 / TQ.02 / TQ.03
Fixação	FT.11.01
Sifão	1680.C.114 / 1682.C.112
Válvula de Escoamento	1605.C.114 / 1606.C.112

COLUNA DE TANQUE

Linha	CT.11 / CT.25
Fixação	SP.13.01

dimensões em milímetros

DualFlux

Um sistema inteligente que economiza água e preserva o meio ambiente.

Quando você economiza recursos, todo mundo sai ganhando. Afinal, além de diminuir a conta no fim do mês, você ainda ajuda a preservar o meio ambiente.

Pensando assim, a Deca criou o DualFlux.

Um sistema de descarga de alta tecnologia que, com 2 opções de acionamento, permite o consumo racional de água nos sanitários.

Você usa sempre de acordo com sua necessidade, economiza água e contribui para um futuro sustentável.

COMO FUNCIONA?	
■ Meia descarga ≈ 3 litros:	Indicado para transporte de líquidos.
■ Descarga completa ≈ 6 litros:	Indicado para transporte de sólidos.
INSTALAÇÃO	
■ Dual Flux acompanha alguns modelos de bacias. Também é opção nos modelos competitivos.	



1. Botão de acionamento.
2. Corpo do mecanismo.
3. Extravasador.



dimensões em milímetros

ASSENTO COM SLOW CLOSE

- Sistema de fechamento slow close que, ao mínimo toque, permite à tampa e ao assento um fechamento suave;

AP.165
assento plástico slow close
compatível com as linhas
Studio, Ravena e Izy

AP.215
assento plástico slow close
compatível com a linha Quadra

AP.237
assento poliéster slow close
compatível com as linhas Link,
Omega, Carrara, Nuova e Duna

AP.394
assento plástico slow close
compatível com a linha Spot

AP.337
assento poliéster slow close
compatível com a linha Piano

ASSENTO COM EASY CLEAN

- Sistema que permite a retirada do assento com um clique;
- Facilita a limpeza do assento e da bacia;
- Todos os assentos Easy Clean possuem o sistema de fechamento Slow Close e são feitos em termofixo;

API.166
compatível com a linha
STUDIO KIDS

AP.516
compatível com a linha
VOGUE PLUS

AP.816
compatível com a linha
MONTE CARLO

AP.336
compatível com as linhas
QUADRA e PIANO

AP.236
compatível com as linhas
LK, OMEGA, CARRARA,
NUOVA e DUNA

AP.196
compatível com a
linha DK

**ASSENTO COM MICROBAN**

Todos os assentos Deca (exceto assentos termofixos e os assentos de plástico AP.165, AP.215 e AP.394) contam com proteção antibacteriana MICROBAN.



Esta proteção confere ao produto:

- Inibição de bactérias causadoras de maus odores, manchas e doenças.
- Ação contínua, inclusive durante o uso, por toda a vida do assento.
- Maior segurança e proteção, com mais higiene para toda a família.

obs:

- A proteção Microban não substitui a necessidade de limpeza, mas é um complemento à higiene do seu assento Deca.
- A tecnologia é incorporada durante a fabricação, e não sai com a lavagem e limpeza do assento.
- Microban é de propriedade da Microban Products Company - EUA

IMPORTANTE

- as dimensões apresentadas neste catálogo são nominais, podendo apresentar uma tolerância de +/- 3%



CUBAS

CUBAS DE PISO	75
CUBAS DE APOIO	77
CUBAS DE APOIO / SOBREPOR	91
CUBAS DE SOBREPOR	93
CUBAS DE SEMI-ENCAIXE	102
CUBAS SUSPENSAS	105
CUBAS DE EMBUTIR	107
SÉRIE LAVABO	110
CUBAS MULTIUSO	111
ITENS DE INSTALAÇÃO	112
DICAS DE INSTALAÇÃO	113

LC.1272*
cuba de piso cilíndrica
com mesa

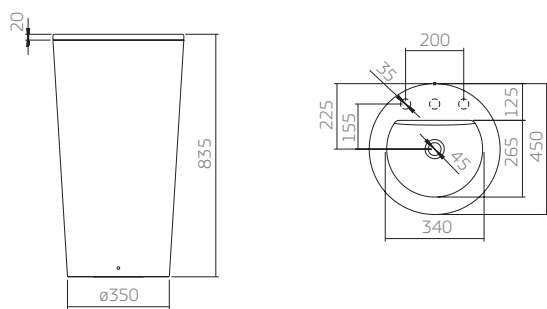

Acompanha fixação, sifão e flexíveis.

17 branco 95 ébano 22 marrom fosco



NOVO

LC.1271
cuba de piso cilíndrica
sem mesa

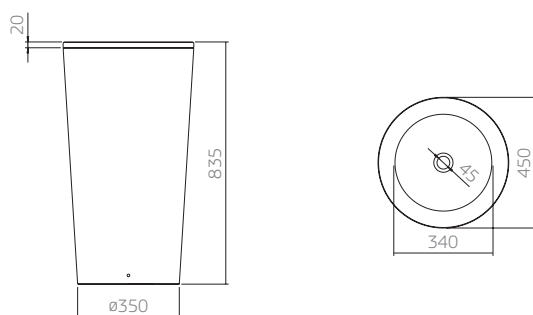

Acompanha fixação e sifão.

17 branco 95 ébano 22 marrom fosco



NOVO

* Não recomendável a utilização desta cuba com os metais das linhas Twist, Stick, Quadratta, Quadratta Clássica, Touch, Dream, Dream Clássica, Cubo, 1875.C.90, 1191.C94, 1877.C94, 1191.C33, e 1877.C33.

dimensões em milímetros

LC.26
cuba de apoio com coluna

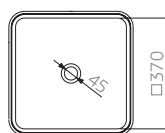
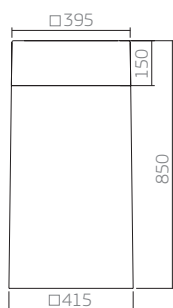

Acompanha fixação e sifão.

17 branco 95 ébano 94 ébano fosco 22 marrom fosco



L.29*
cuba retangular
com válvula oculta

C.29
(coluna)

Acompanha fixação e
válvula oculta.

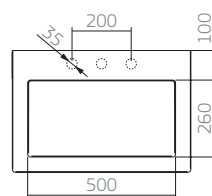
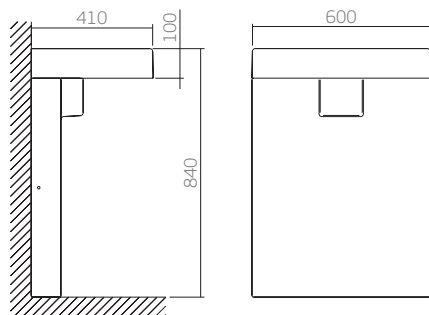

17 branco 95 ébano



* Utilizar sempre com coluna C.29.
Esta cuba não deve ser instalada com os metais: 1875.C81P, 1180.C e 1183.C.

dimensões em milímetros

L.117
cuba retangular
de apoio

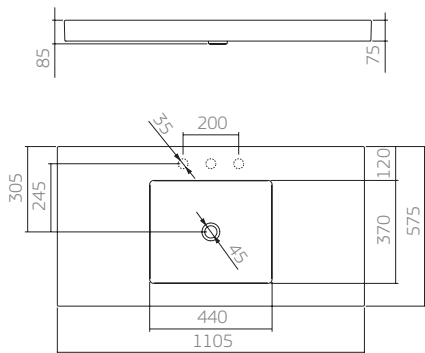

17 branco 95 ébano

L.1055
cuba retangular

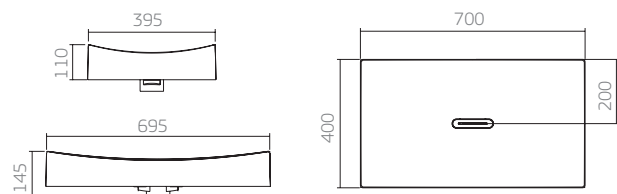

Acompanha válvula de
escoamento.

17 branco 95 ébano 94 ébano fosco 22 marrom fosco



L.19
cuba de apoio retangular

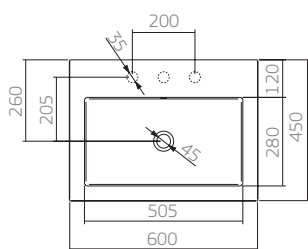

17 branco 95 ébano

L.197
cuba de apoio retangular

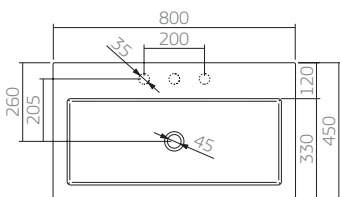

17 branco

dimensões em milímetros

L.1039
cuba de apoio

17 branco 95 ébano

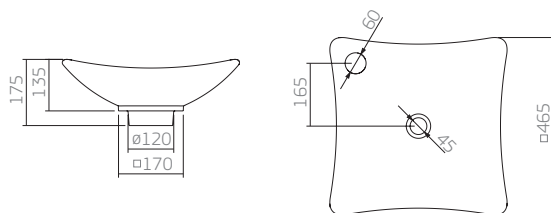

L.1034
cuba de apoio triangular

17 branco 95 ébano 94 ébano fosco 22 marrom fosco

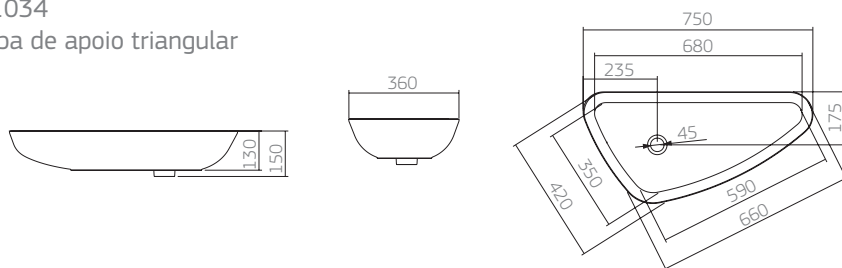

L.1038
cuba de apoio elíptica

17 branco 95 ébano

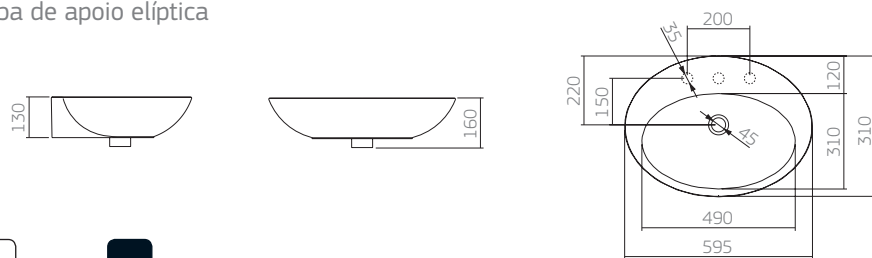

dimensões em milímetros

L.88*
cuba retangular com
válvula oculta

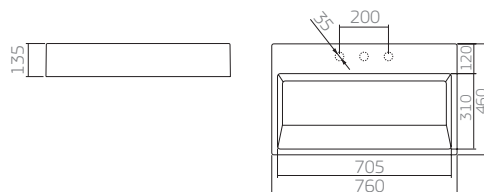

17 branco 95 ébano

L.87*
cuba retangular com
válvula oculta

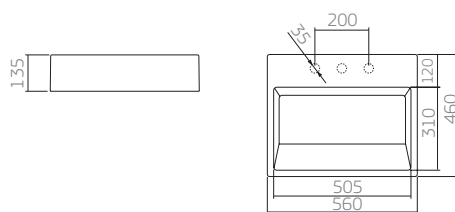

17 branco 95 ébano 94 ébano fosco 22 marrom fosco

L.86*
cuba quadrada
com válvula oculta

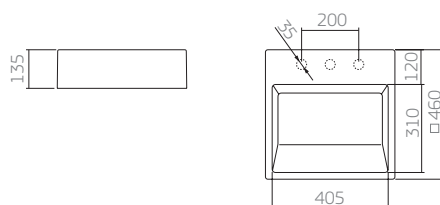

17 branco 95 ébano

* Acompanha válvula oculta.
Não recomendável com metais Axis.

dimensões em milímetros

CUBAS DE APOIO

L.1060C
cuba de apoio com
saboneteira de metal

NOVO

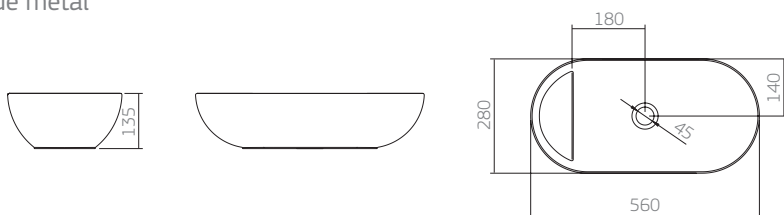

17 branco 95 ébano

L.1045M*
cuba de apoio com
saboneteira de madeira

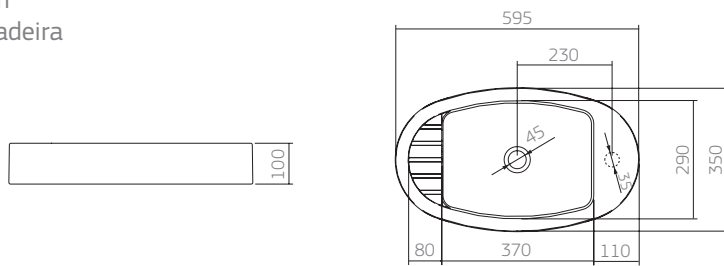

17 branco 95 ébano

L.195
cuba de apoio retangular

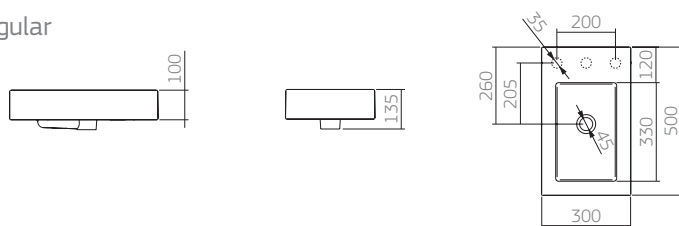

17 branco

L.196
cuba de apoio retangular

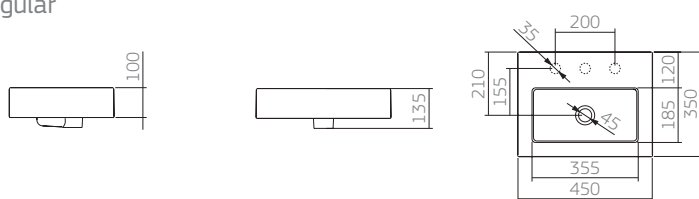

17 branco

* Esta cuba possui apenas 1 furo para instalação de metais de mesa. Verificar metais compatíveis.

dimensões em milímetros

L.1057
cuba de apoio retangular

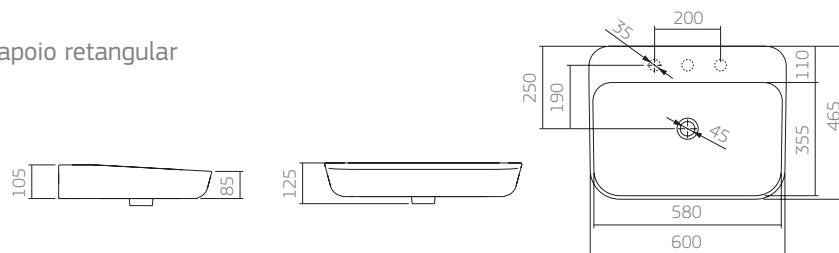

17 branco 95 ébano

L.1035
cuba de apoio oblonga

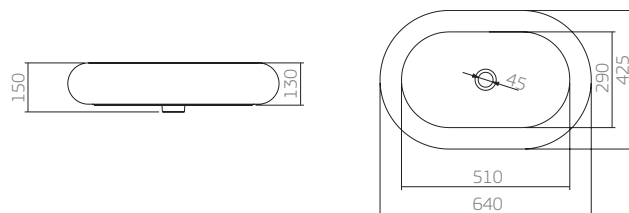

17 branco 95 ébano

L.125
cuba de apoio com mesa

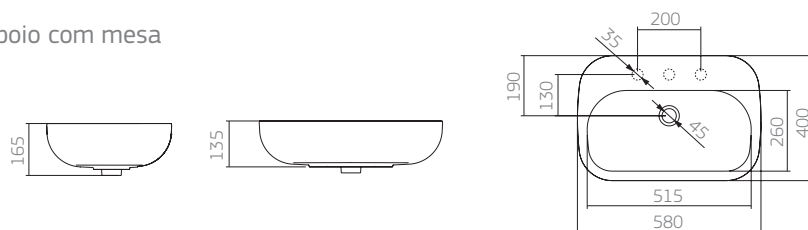

17 branco 95 ébano

dimensões em milímetros

CUBAS DE APOIO

L.1065
cuba trapezoidal

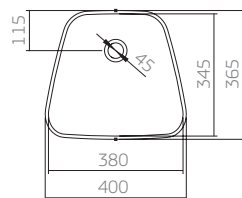

NOVO

- 17 branco
- 95 ébano
- 94 ébano fosco
- 22 marrom fosco

L.270
cuba de apoio retangular

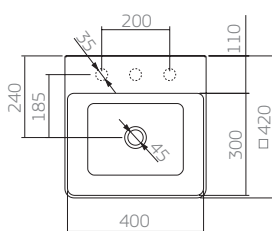
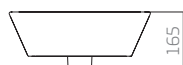
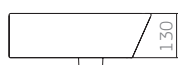

- 17 branco
- 95 ébano
- 94 ébano fosco
- 22 marrom fosco

L.1037
cuba de apoio quadrada

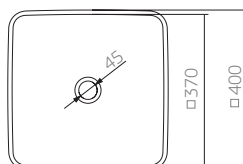
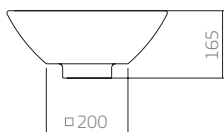
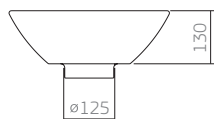

- 17 branco
- 95 ébano

L.1036
cuba de apoio meia lua

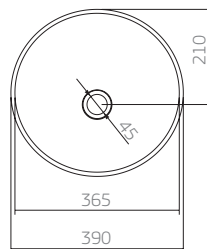
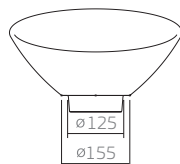
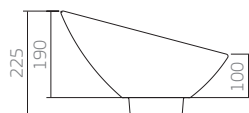

- 17 branco
- 95 ébano
- 94 ébano fosco
- 22 marrom fosco

dimensões em milímetros

L.126
cuba de apoio cilíndrica

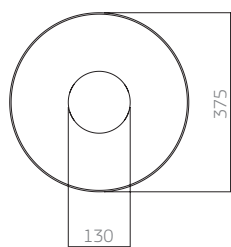

17 branco 95 ébano

L.1059
cuba de apoio redonda

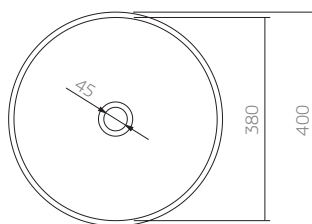
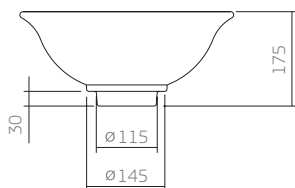

17 branco 95 ébano

L.904
cuba de apoio cilíndrica com mesa

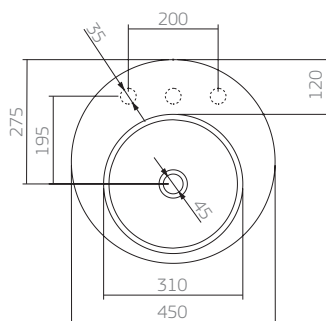
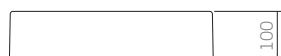

17 branco 95 ébano

dimensões em milímetros

L.105*
cuba de apoio

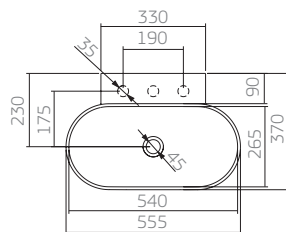

17 branco 95 ébano

L.106
cuba de apoio

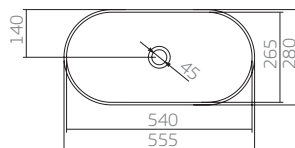
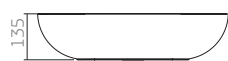

17 branco 95 ébano

L.68
cuba de apoio oval

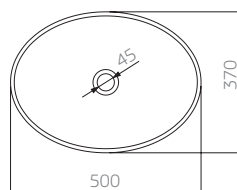
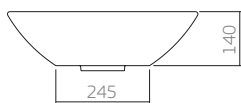
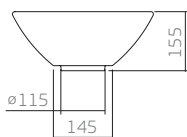

17 branco 37 creme 95 ébano

* Esta cuba não pode ser instalada com os metais das linhas Stick, Quadratta Clássica, Touch, 1191.C96, 1191.C94, 1191.C33, 1180.C e 1183.C.

dimensões em milímetros

L.71*
cuba de apoio cilíndrica
com mesa

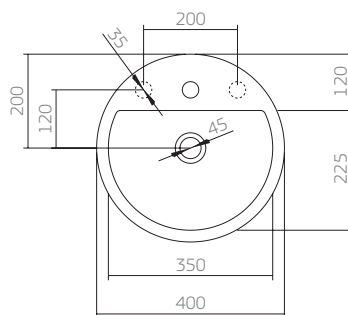

17 branco 37 creme 95 ébano

L.92
cuba de apoio cilíndrica

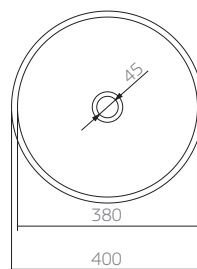
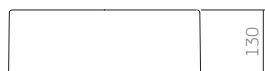

17 branco 95 ébano

L.93
cuba de apoio oval

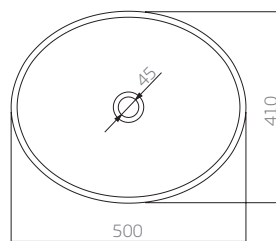

17 branco 95 ébano

* Não recomendamos a utilização desta cuba com metais das linhas: Twist, Stick, Quadratta Clássica, Touch, Dream, Dream Clássica, Cubo, 1875.C90, 1191.C94, 1877.C94, 1191.C33, 1877.C33 e 1877.C.CLN.

dimensões em milímetros

L.73
cuba de apoio
quadrada com mesa

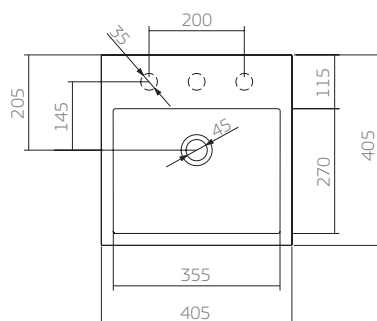

- 17 branco
- 95 ébano
- 94 ébano fosco
- 22 marrom fosco
- 37 creme

L.7300
cuba de apoio
quadrada com mesa

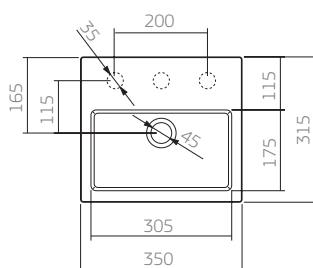
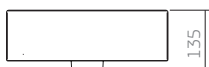

- 17 branco
- 95 ébano

L.7400
cuba de apoio
retangular

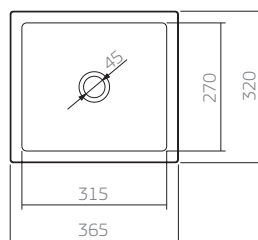
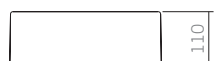

- 17 branco
- 95 ébano

dimensões em milímetros

L.260
cuba de apoio
quadrada

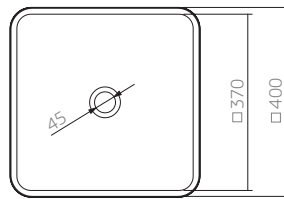
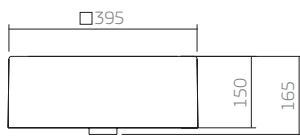

- 17 branco
- 95 ébano
- 94 ébano fosco
- 22 marrom fosco

L.108
cuba de apoio
quadrada

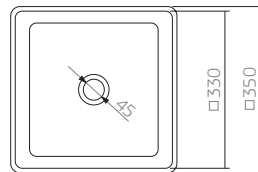

- 17 branco
- 95 ébano

L.1046
cuba de apoio
quadrada

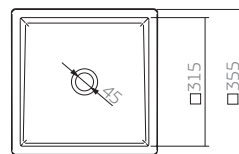
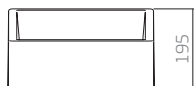
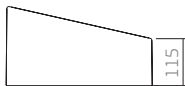

- 17 branco
- 95 ébano

dimensões em milímetros

L.70
cuba quadrada de apoio

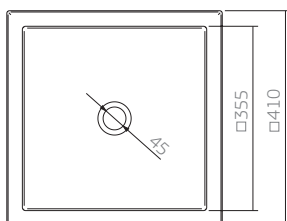

17 branco 95 ébano

L.107
cuba retangular de apoio

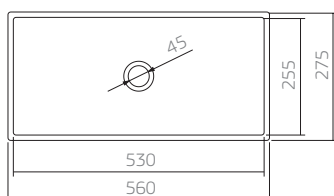

17 branco 95 ébano

L.102*
cuba retangular de apoio

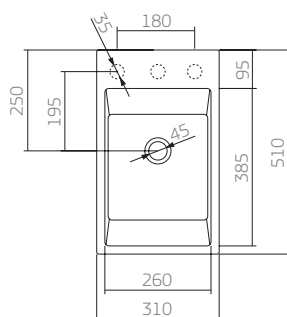

17 branco 95 ébano

* Não recomendamos a utilização desta cuba com os metais das linhas Stick, Quadratta Clássica, Touch, 1191.C96, 1191.C94 e 1191.C33.

dimensões em milímetros

L.55
cuba de apoio
redonda

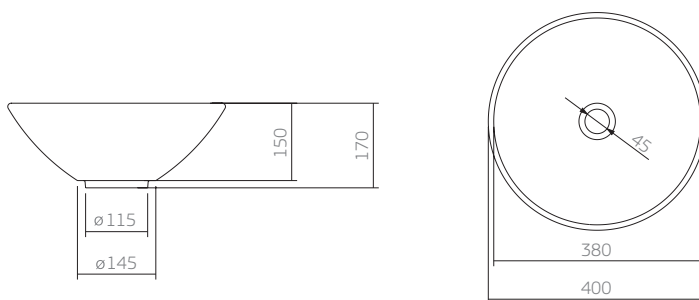

17 branco 37 creme 95 ébano

L.155
cuba de apoio
redonda

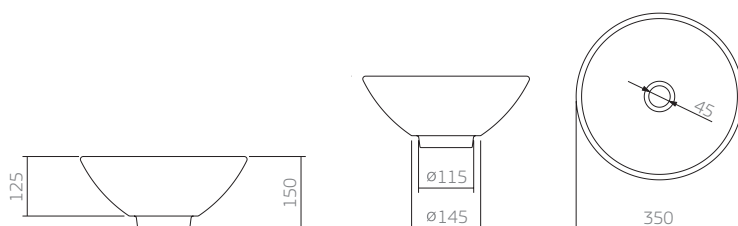

17 branco 37 creme 95 ébano

L.46C
cuba de apoio com
anel metálico

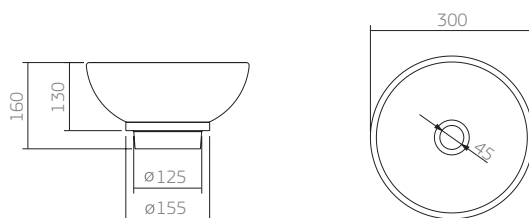

L.460
cuba de apoio sem
anel metálico

17 branco 95 ébano

dimensões em milímetros

CUBAS DE APOIO

L.69
cuba de apoio oval

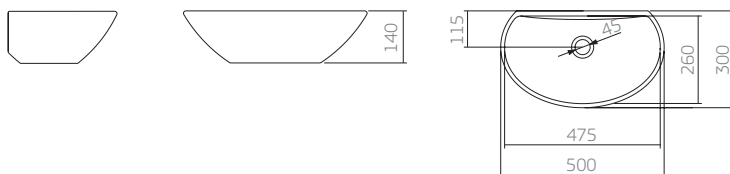

17 branco 95 ébano

L.69
cuba de apoio
parede oval + C.69
coluna suspensa
para L.69

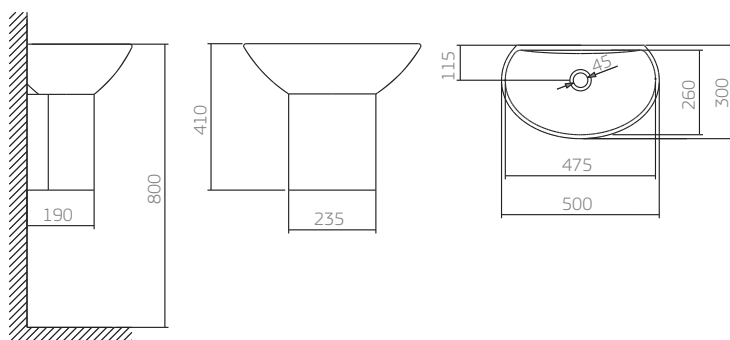

17 branco 95 ébano

dimensões em milímetros

L.95
cuba retangular

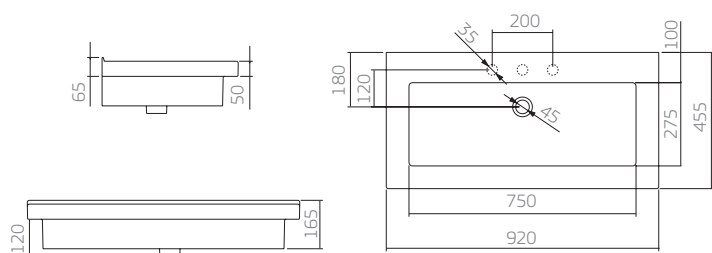

17 branco 95 ébano

L.94
cuba retangular

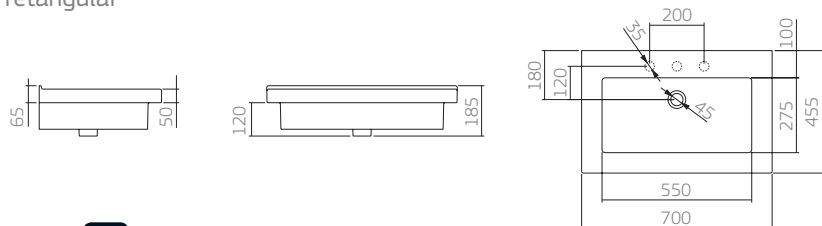

17 branco 95 ébano

dimensões em milímetros

L.98
cuba quadrada com mesa

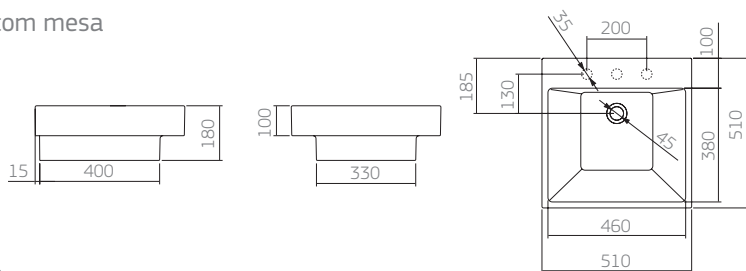

17 branco **95** ébano

L.90*
cuba cilíndrica

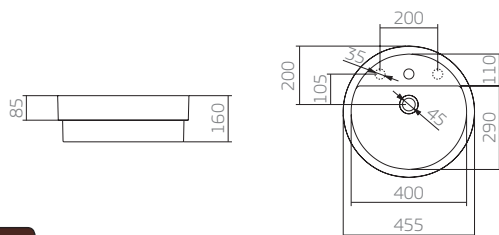

17 branco **95** ébano **94** ébano fosco **22** marrom fosco

* Não recomendamos a utilização desta cuba com os metais das linhas Twist, Stick, Quadratta, Quadratta Clássica, Touch, Dream, Dream Clássica, Cubo, 1875.C90, 1191.C94, 1877.C94, 1191.C33, 1877.C33 e 1877.C.CLN.

dimensões em milímetros

L.1044C
cuba com saboneteira grelha

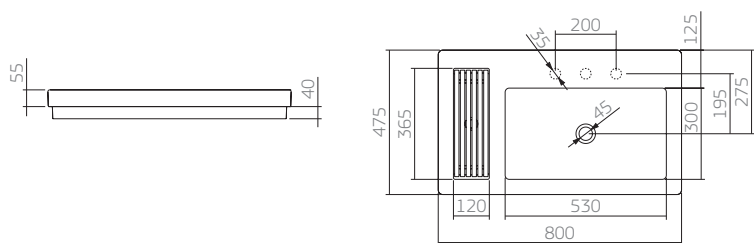

- 17 branco
- 95 ébano
- 94 ébano fosco
- 22 marrom fosco

L.1056C
cuba quadrada com
anel metálico

NOVO

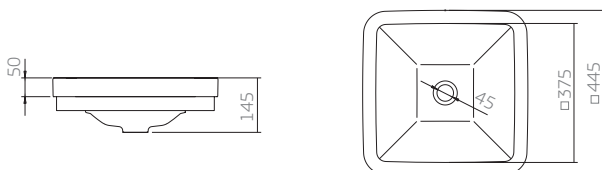

- 17 branco
- 95 ébano

L.89
cuba retangular com válvula oculta

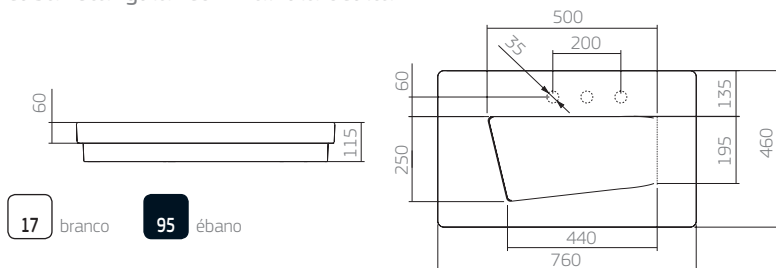

- 17 branco
- 95 ébano

L.1032
cuba retangular com duas
opções de mesa para metais

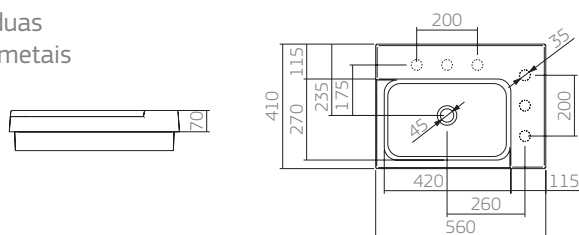

- 17 branco
- 95 ébano

dimensões em milímetros

L.870
cuba retangular
com válvula oculta

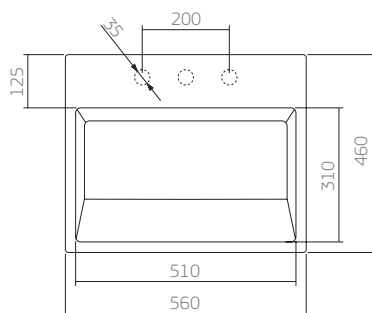
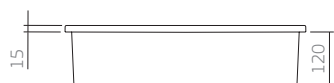

17 branco 95 ébano

L.103
cuba quadrada com
bojo redondo

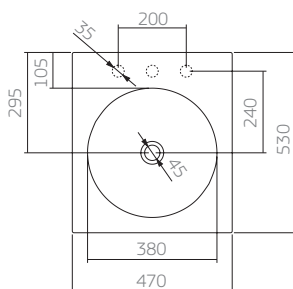

17 branco 95 ébano

L.1130
cuba quadrada

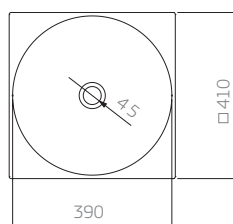

17 branco 95 ébano

dimensões em milímetros

L.1042C
cuba com grelha e
válvula oculta

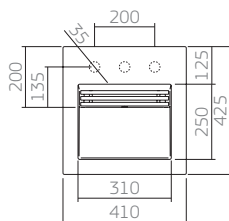
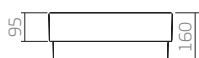

17 branco 95 ébano 94 ébano fosco 22 marrom fosco

L.1150
cuba quadrada

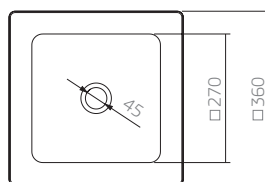
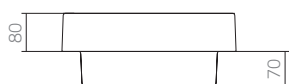

17 branco 95 ébano

L.1160
cuba quadrada

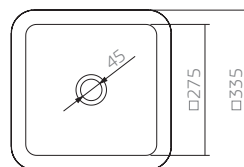

17 branco 95 ébano

dimensões em milímetros

L.1056
cuba quadrada

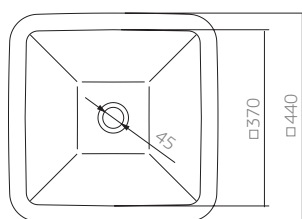

17 branco 95 ébano

L.840
cuba retangular
com mesa

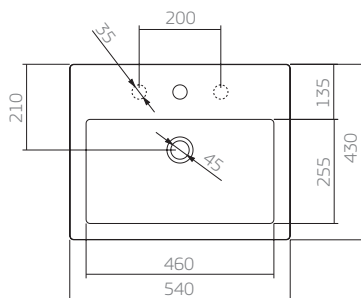

17 branco 95 ébano

L.730
cuba quadrada
com mesa

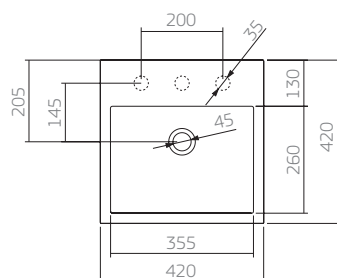
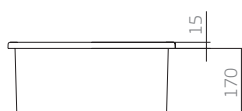

17 branco 95 ébano 94 ébano fosco
22 marrom fosco 37 creme

dimensões em milímetros

L.1170
cuba retangular
com mesa

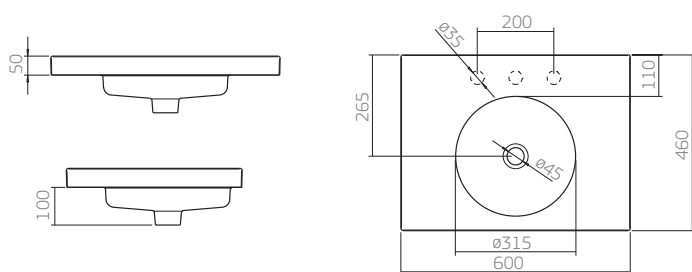

17 branco 95 ébano

L.1070
cuba retangular

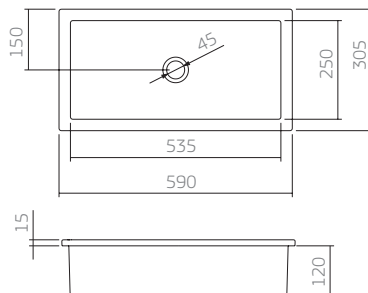

17 branco 95 ébano

L.700
cuba quadrada

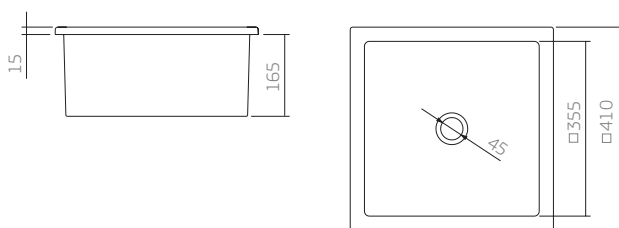

17 branco 95 ébano

dimensões em milímetros

L.1050
cuba cilíndrica

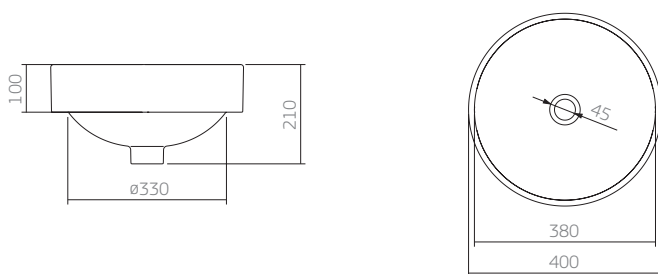

17 branco 95 ébano 94 ébano fosco 22 marrom fosco

L.1271
cuba redonda

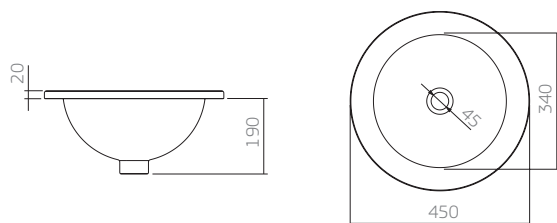

17 branco 95 ébano

L.1272*
cuba redonda

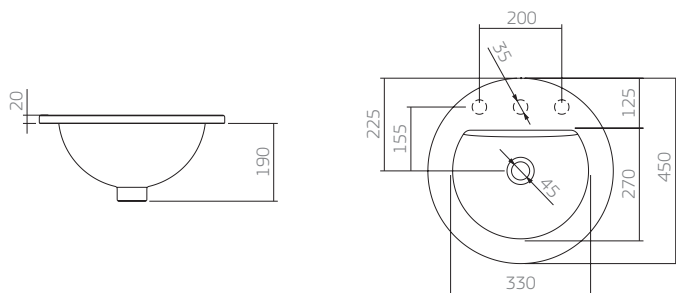

17 branco 95 ébano

* Não recomendamos a utilização desta cuba com os metais das linhas Twist, Stick, Quadratta, Quadratta Clássica, Touch, Dream, Dream Clássica, Cubo, 1875.C90, 1191.C94, 1877.C94, 1191.C33 e 1877.C33.

dimensões em milímetros

LL.170
cuba oval com ladrão

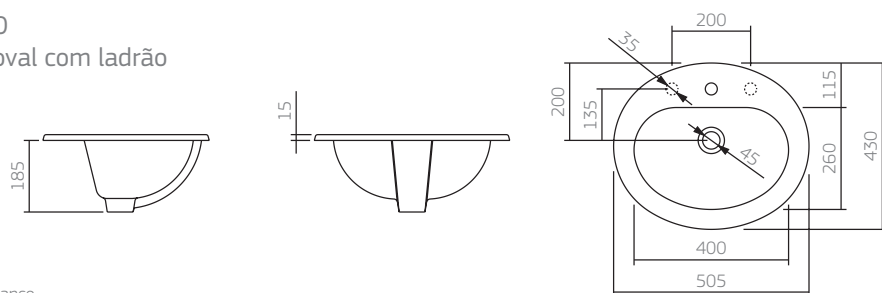

17 branco



L.64
cuba oval

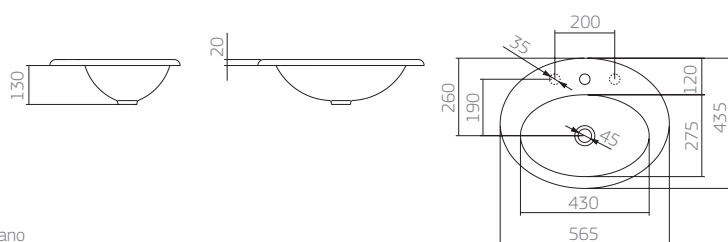

17 branco 95 ébano



L.680
cuba redonda

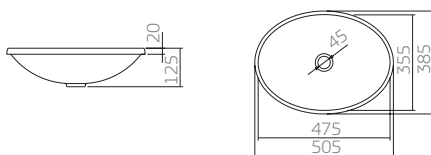

17 branco 95 ébano



dimensões em milímetros

CUBAS DE SOBREPOR

L.550
cuba redonda

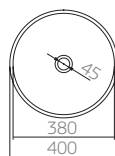

17 branco 95 ébano

L.43
cuba retangular

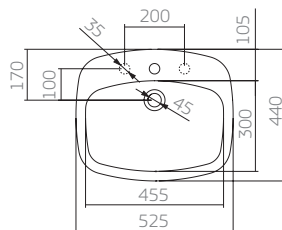

17 branco 37 creme

L.65
cuba oval

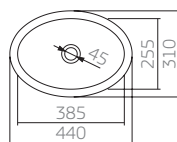

17 branco 95 ébano 23 caramelo 37 creme
51 azul 60 verde 87 cinza 89 rosa

dimensões em milímetros

L.50
cuba redonda

- | | | | |
|------------------|-----------------|--------------------|-----------------|
| 17 branco | 95 ébano | 23 caramelo | 37 creme |
| 51 azul | 60 verde | 87 cinza | 89 rosa |

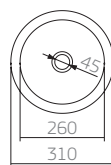

L.49
cuba para sobrepor oval

- | | | |
|------------------|-----------------|-----------------|
| 17 branco | 37 creme | 95 ébano |
|------------------|-----------------|-----------------|

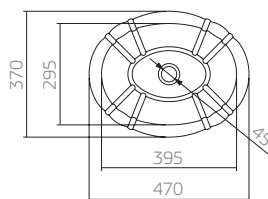
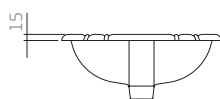
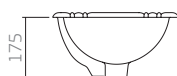

L.54
cuba retangular

- | | |
|------------------|-----------------|
| 17 branco | 95 ébano |
|------------------|-----------------|

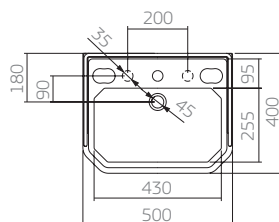
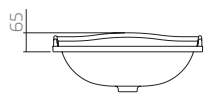
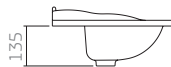

dimensões em milímetros

L.873*
cuba retangular
com válvula oculta

17 branco 95 ébano

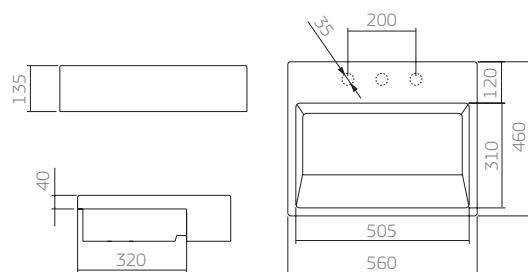

L.863*
cuba quadrada com
válvula oculta

17 branco 95 ébano

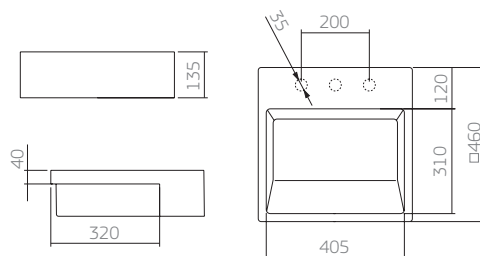

L.843
cuba de semi-
encaixe retangular

17 branco 95 ébano

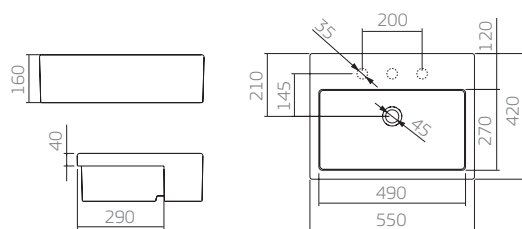

* Acompanha válvula oculta.
Não recomendada com metal Axis.

dimensões em milímetros

L.830
cuba quadrada
com mesa

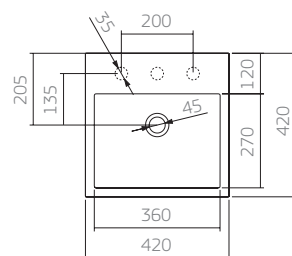
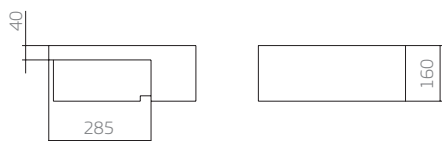

- 17 branco
- 95 ébano
- 94 ébano fosco
- 22 marrom fosco

L.83C
cuba quadrada
com mesa com
porta-toalha
cromado

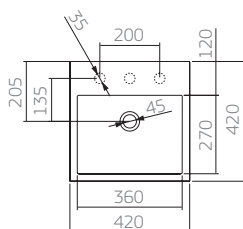
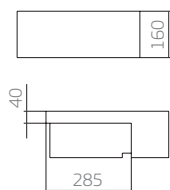

- 17 branco
- 95 ébano

L.800
cuba quadrada

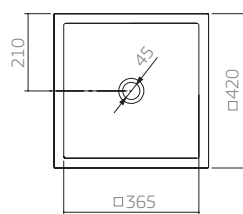
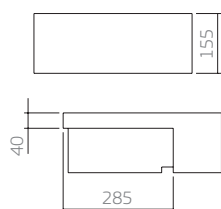

- 17 branco
- 95 ébano

dimensões em milímetros

L.903*
cuba de
semi-encaixe
cilíndrica

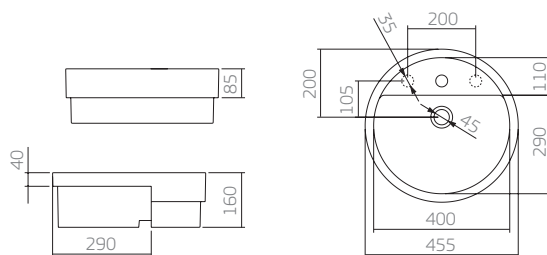

17 branco 95 ébano



L.62
lavatório para
semi-encaixe

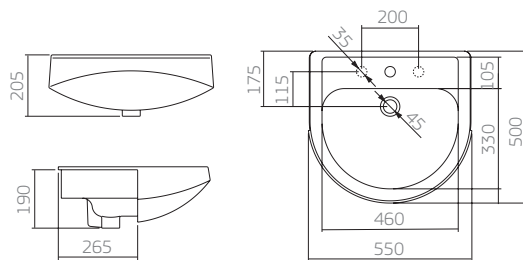

17 branco 37 creme 95 ébano



L.82
lavatório para
semi-encaixe

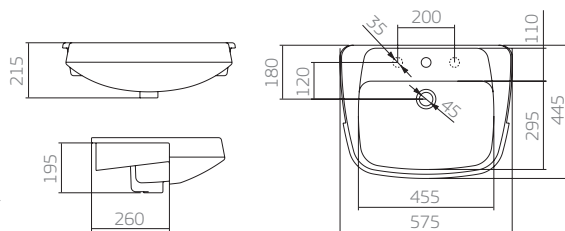

17 branco 37 creme 87 cinza
95 ébano 60 verde 51 azul



* Não recomendamos a utilização desta cuba com os metais das linhas: Twist, Stick, Quadratta, Quadratta Clássica, Touch, Dream, Dream Clássica, Cubo, 1875.C90, 1191.C94, 1877.C94, 1191.C33, 1877.C33 e 1877.CCLN.

dimensões em milímetros

NOVO

L.1120.G17.17
cuba retangular
com gaveta



L.1120.G95.95
cuba retangular
com gaveta

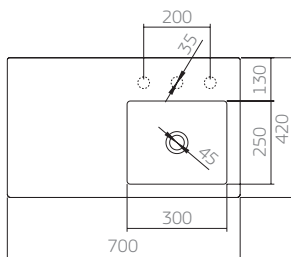
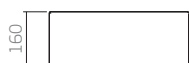

17 branco 95 ébano Acompanha fixação.

L.99**
lavatório slim
cuba retangular com
válvula oculta

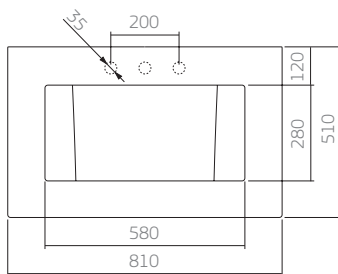
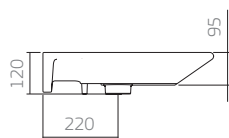
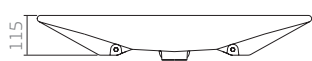

17 branco 95 ébano

L.63C
lavatório com porta-
toalha cromado

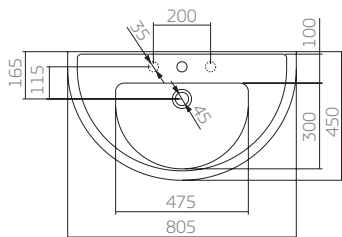
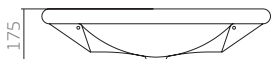

17 branco 95 ébano

LI.79C*
lavatório com porta-
toalha frontal inteiro

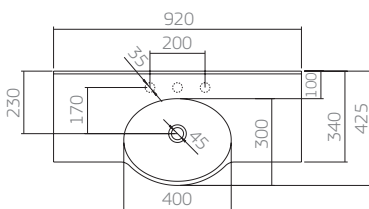
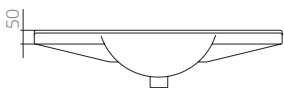
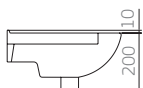

17 branco 95 ébano

* Acompanha o produto: (SP.13 + SP.10 + SP.9)

** Acompanha o produto: (SP.9 + SP.13 + SP.10 + VE.01.01)

dimensões em milímetros

L.78C
lavatório elíptico com
mesa e porta toalha

17 branco 95 ébano

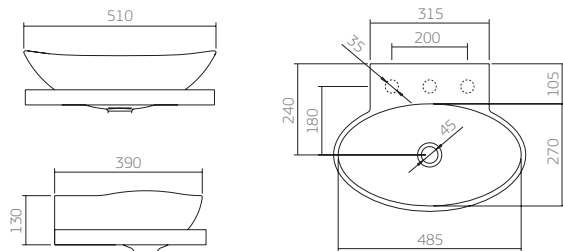

L.76
lavatório de canto

Acompanha fixação.

17 branco 95 ébano

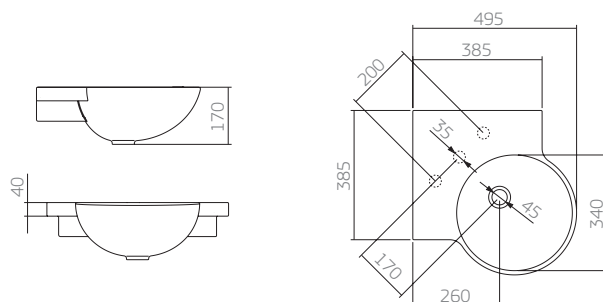

L.102C*
cuba retangular suspena
com porta-toalha

17 branco 95 ébano

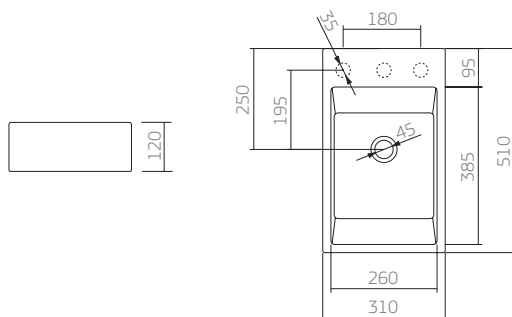

L.71C**
cuba cilíndrica
suspensa com porta-
toalha cromado

Acompanha fixação.

17 branco 95 ébano

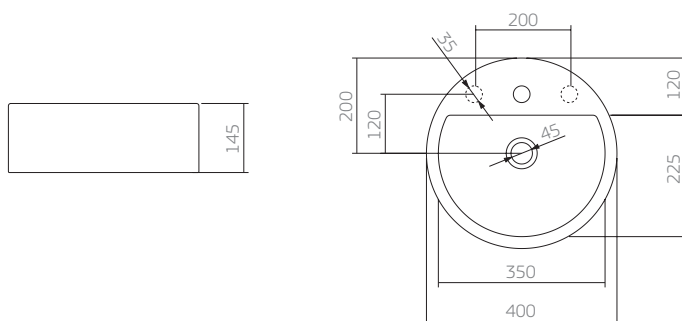

* Acompanha o produto: SP.13

dimensões em milímetros

Não recomendamos a utilização desta cuba com os metais das linhas Stick, Quadratta Clássica, Touch, 1191.C96, 1191.C94 e 1191.C33.

** Não recomendamos a utilização desta cuba com os metais das linhas:

Twist, Stick, Quadratta, Quadratta Clássica, Touch, Dream, Dream Clássica, Cubo, 1875.C90, 1191.C94, 1877.C94, 1191.C33, 1877.C33 e 1877.C.CLN.

L.301
cuba retangular
com mesa

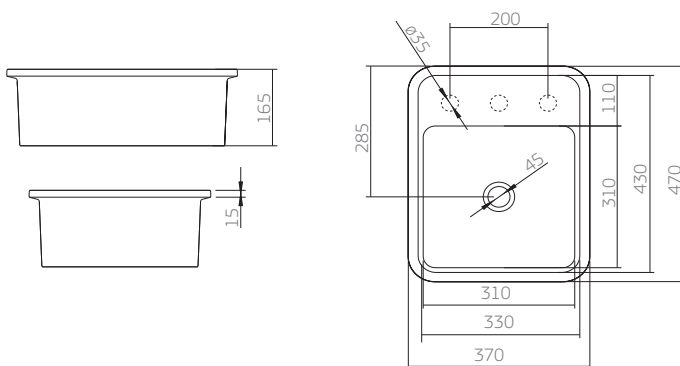

NOVO



17 branco 95 ébano

L.1071
cuba retangular

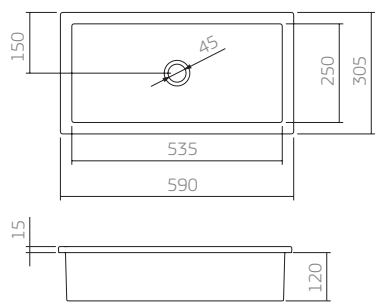

17 branco 95 ébano

L.701
cuba quadrada

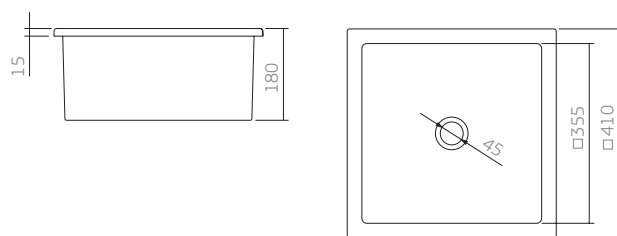

17 branco 95 ébano

dimensões em milímetros

CUBAS DE EMBUTIR

L.1030
cuba de embutir

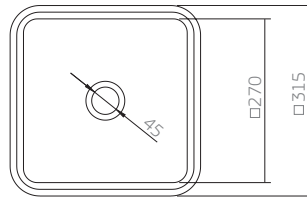
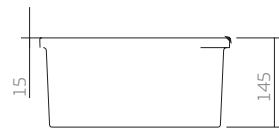

- | | | | | | | | |
|----|--------|----|-------|----|-------|----|----------|
| 17 | branco | 37 | creme | 87 | cinza | 23 | caramelo |
| 95 | ébano | 60 | verde | 51 | azul | 89 | rosa |

L.42
cuba retangular

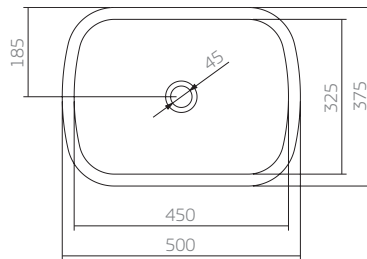
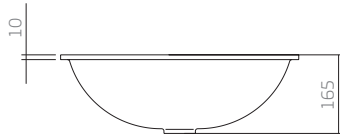

- | | | | |
|----|--------|----|-------|
| 17 | branco | 37 | creme |
|----|--------|----|-------|

L.56
cuba redonda

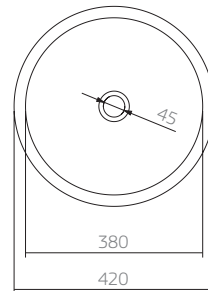
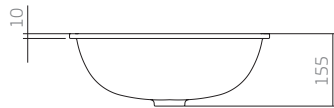

- | | |
|----|--------|
| 17 | branco |
|----|--------|

dimensões em milímetros

L.59
cuba oval

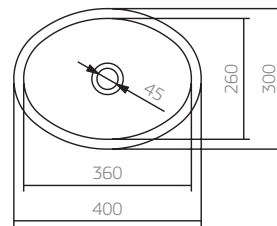
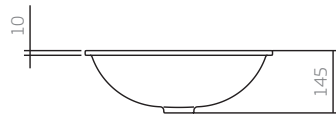

- | | | | |
|------------------|-----------------|-----------------|--------------------|
| 17 branco | 37 creme | 87 cinza | 23 caramelo |
| 95 ébano | 60 verde | 51 azul | 89 rosa |

L.37
cuba oval

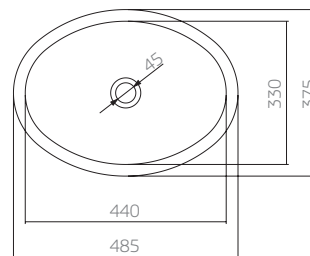
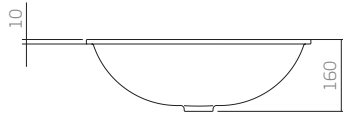

- | | | | |
|------------------|-----------------|-----------------|--------------------|
| 17 branco | 37 creme | 87 cinza | 23 caramelo |
| 95 ébano | 60 verde | 51 azul | 89 rosa |

L.41
cuba redonda

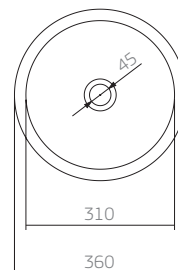
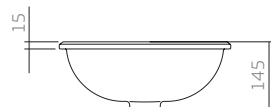

- | | | | |
|------------------|-----------------|-----------------|--------------------|
| 17 branco | 37 creme | 87 cinza | 23 caramelo |
| 95 ébano | 60 verde | 51 azul | 89 rosa |

dimensões em milímetros

SL.01
suporte para cuba
de apoio

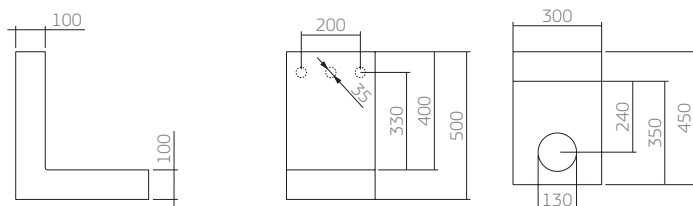

O suporte SL.01 já acompanha fixação (SP.7 + SP.01)
Não recomendamos a utilização do SL.01 com as torneiras de parede 1179.

UTILIZAR O SL.01 COM AS CUBAS:



L.55 / L.155



L.68



L.70



L.92



L.93

17 branco 95 ébano

E.79C
prateleira com porta
toalha cromado



17 branco 95 ébano



dimensões em milímetros

L.110**
 cuba multiuso
 com esfregador em
 madeira capacidade
 total 45 litros

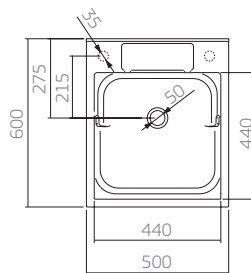
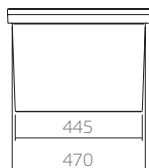
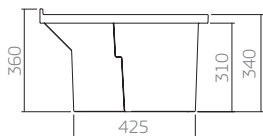

17 branco 95 ébano

L.116D*
 cuba multiuso com mesa
 lado direito e esfregador
 em madeira capacidade
 total 34,5 litros

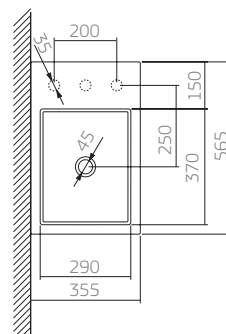
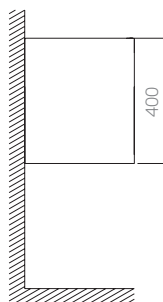

17 branco 95 ébano

* Acompanha o produto: fixação.
 Utiliza válvula de escoamento 1605.C - 1 ¼"
 ** Utiliza válvula de escoamento 1606.C - 1 ½"

dimensões em milímetros

CUBAS DE APOIO

Sifão	1684.C.100.112 / 1685.C.100.112 1680.C.100.112 / 1682.C.100.112
Válvula de Escoamento	1601.C / 1601.C.CLI 1602.C.PLA / 1602.C

CUBAS DE SOBREPOR

Sifão	1684.C.100.112 / 1685.C.100.112 1680.C.100.112 / 1682.C.100.112
Válvula de Escoamento	1601.C / 1601.C.CLI 1602.C.PLA / 1602.C

CUBAS DE SEMI-ENCAIXE

Sifão	1684.C.100.112 / 1685.C.100.112 1680.C.100.112 / 1682.C.100.112
Válvula de Escoamento	1601.C / 1601.C.CLI 1602.C.PLA / 1602.C

CUBAS SUSPENSAS

Fixação*	Acompanha o produto
Sifão	1684.C.100.112 / 1685.C.100.112 1680.C.100.112 / 1682.C.100.112
Válvula de Escoamento	1601.C / 1601.C.CLI 1602.C.PLA / 1602.C

CUBAS DE EMBUTIR

Sifão	1684.C.100.112 / 1685.C.100.112 1680.C.100.112 / 1682.C.100.112
Válvula de Escoamento	1601.C / 1601.C.CLI 1602.C.PLA / 1602.C

* para cuba L.63C utilizar a fixação SP.13.01

CUBAS COM VÁLVULA OCULTA

Válvula de Escoamento	Não utiliza válvula de escoamento
-----------------------	-----------------------------------

CUBAS DE PISO

Sifão*	Acompanha o produto
Válvula de Escoamento	1601.C / 1601.C.CLI 1602.C.PLA / 1602.C
Fixação	Acompanha o produto

* para cuba L.29 + C.29 utilizar o sifão 1682.C.100.112

dimensões em milímetros

IMPORTANTE:

As dimensões apresentadas neste catálogo são nominais, podendo apresentar uma tolerância de $\pm 3\%$

Sugestão de medidas para instalação de cubas de sobrepor.

CUBAS DE SOBREPOR

Produto	Ponto de Esgoto
L.43	310
L.49	325
L.50	265
L.54	285
L.64	280
L.65	295
LL.170	335
L.94	250
L.95	250
L.98	230
L.110	460
L.103	285
L.550	280
L.680	275
L.700	315
L.730	320
L.840	315
L.870	270
L.1070	270
L.89	205
L.1032C	210
L.1042C	215
L.1044C	190
L.1050	260
L.1150	220
L.1160	290
L.1130	220
L.1056	245
L.1271	340
L.1272	340

Sugestão de medidas para instalação de cubas de embutir.

CUBAS DE EMBUTIR

Produto	Ponto de Esgoto
L.37	330
L.41	315
L.42	335
L.56	325
L.59	315
L.701	350
L.1030	280
L.1071	305

Sugestão de medidas para instalação de lavatórios suspensos.

LAVATÓRIOS SUSPENSOS

Produto	Ponto de Esgoto
L.63C	325
L.69	290
L.71	295
L.76	320
LI.79C	310
L.99	270
L.116D	500

Sugestão de medidas para instalação de lavatórios de semi-encaixe.

LAVATÓRIOS DE SEMI-ENCAIXE

Produto	Ponto de Esgoto
L.62	340
L.800	265
L.82	345
L.830	265
L.863	245
L.873	245
L.903	270
L.843	270

dimensões em milímetros

Sugestão de medidas para instalação de lavatórios com coluna suspensa (exceto L510).

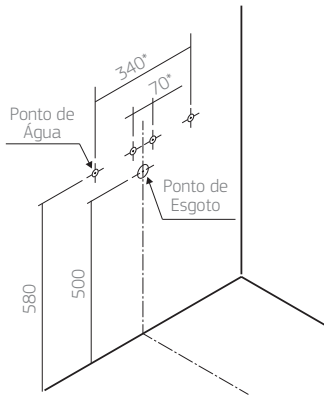

* Opções internas e externas para ponto de água, exceto L510.

Sugestão de medidas para instalação de apoio, exceto cuba com válvula oculta.

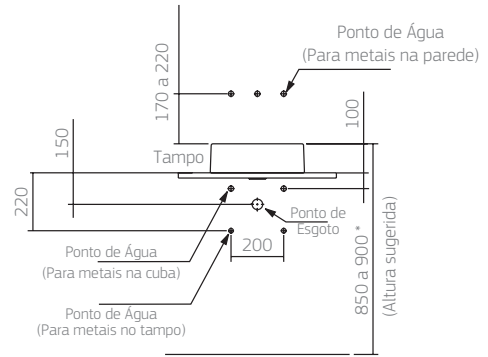

Obs.: para cubas com válvula oculta, ponto de esgoto a 160mm do tampo.
* Exceto PNE, que deve estar entre 780 a 800.

Sugestão de medidas para instalação de cubas de sobrepor, embutir e lavatórios de semi - encaixe.

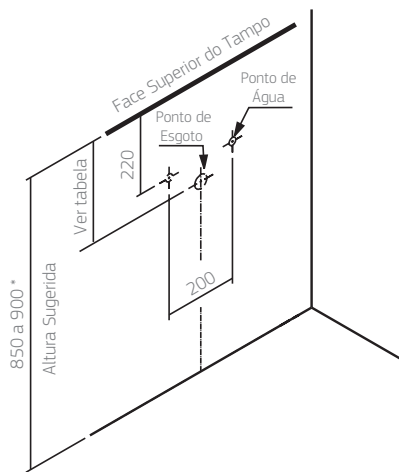

* Exceto PNE, que deve estar entre 780 a 800.

Sugestão de medidas para instalação de lavatórios suspensos sem coluna.

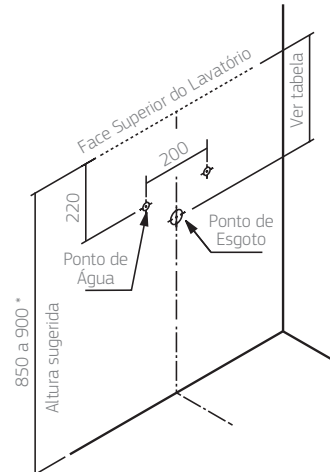

* Exceto PNE, que deve estar entre 780 a 800.

* Medida segundo norma da ABNT - Associação Brasileira de Normas Técnicas

dimensões em milímetros



Deca

METAIS

DOT	119	MONOCOMANDOS DECAMIX	174
TUBE	122	MONOCOMANDOS FORUM	175
TWIST	125	MONOCOMANDOS VOGUE PLUS	176
STICK	127	MONOCOMANDOS LINK	177
ACESSÓRIOS QUADRATTA	129	MONOCOMANDOS SMART	178
QUADRATTA	131	SKY	180
QUADRATTA CLÁSSICA	132	ACESSÓRIOS POLO	182
ACESSÓRIOS ANNA	134	POLO	184
ACESSÓRIOS WINDSOR	137	LINK QUADRATTA	186
WINDSOR	138	STUDIO	187
UNIC	139	CLEAN	189
DECA WISH	140	DISCO	191
DECA TOUCH	142	KIDS	193
DREAM	143	IZY PLUS	200
DREAM CLÁSSICA	145	ACESSÓRIOS IZY	202
ACESSÓRIOS OXFORD	147	IZY	203
OXFORD	148	ACESSÓRIOS CLEAN	207
SLIDE	150	ACESSÓRIOS DISCO	208
AXIS	152	LINK	209
COTEMPORÂNEA	154	ACESSÓRIOS BELLE ÉPOQUE	211
DUNA QUADRATTA	155	BELLE ÉPOQUE TRADICIONAL	213
CUBO	157	PRATA	215
DUNA	159	ACESSÓRIOS TARGA	217
DUNA CLÁSSICA	160	TARGA	218
STAR	162	ASPEN	220
SPIN	164	MAX	222
ACESSÓRIOS SLIM	166	SPOT	224
SABONETEIRA DE APOIO	168	ACESSÓRIOS EVIDENCE	226
MONCOMANDOS DECA TOUCH	169	ACESSÓRIOS FLEX	228
MONOCOMANDOS UNIC	170	TORNEIRAS DE PAREDE	230
MONOCOMANDOS AXIS	172	TORNEIRAS PARA LAVATÓRIO	234



1877.C.DOT.BR
misturador lavatório
mesa

1877.C.DOT
misturador lavatório
mesa

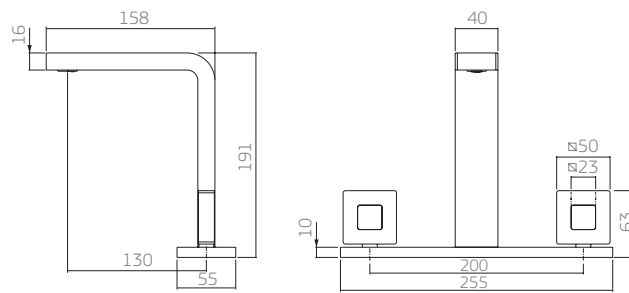

1191.C.DOT.BR
torneira lavatório
mesa

1191.C.DOT
torneira lavatório
mesa

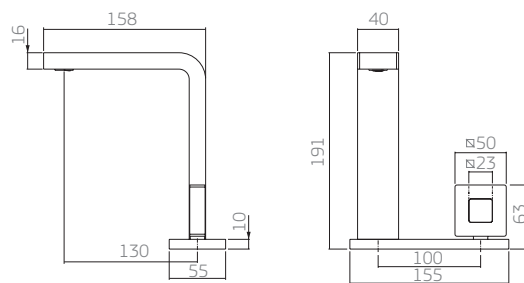

1873.C.DOT.BR
misturador lavatório
parede vertical

1873.C.DOT
misturador lavatório
parede vertical

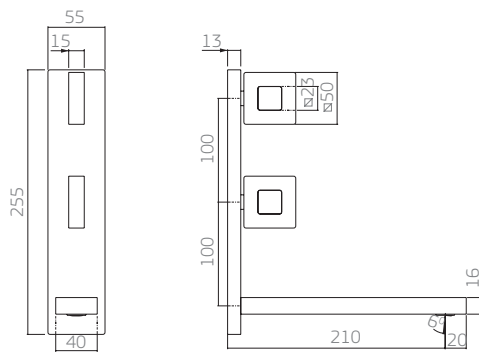

C.DOT.BR
cromado/
branco



C.DOT
cromado

Utilizar a furação no tampo de 35mm para misturadores e torneiras de mesa

dimensões em milímetros

NOVO

1874.C.DOT.BR
misturador
lavatório parede
horizontal



1874.C.DOT
misturador
lavatório parede
horizontal

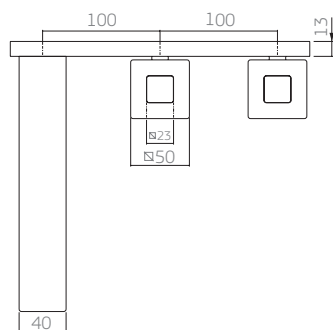

1179.C.DOT.BR
torneira lavatório
parede

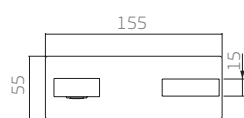

1179.C.DOT
torneira lavatório
parede

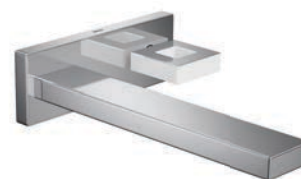
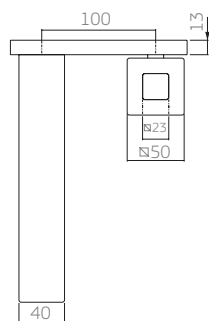

- 1895.C.DOT - misturador para bidê
- 4900.C.DOT - acabamento para registro
- 4916.C.DOT.PQ - acabamento para registro de pressão com mecanismo MVR (1/2 volta)
- 1416.C.DOT - registro de pressão
- 1509.C.DOT - registro de gaveta

dimensões em milímetros

NOVO

2998.C.DOT.BR
misturador para chuveiro

2998.C.DOT
misturador para chuveiro

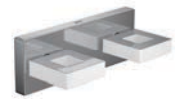
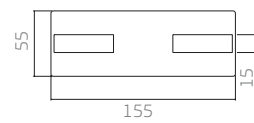
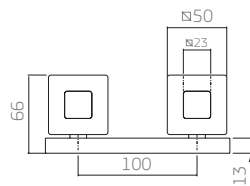

1984.C.DOT.ACT.CBR
ducha higiênica com registro e derivação

1984.C.DOT.ACT.CR
ducha higiênica com registro e derivação

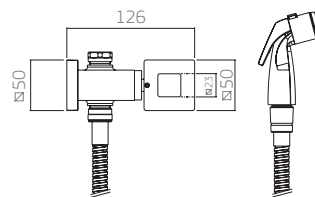

Comprimento do flexível 1,20m.

dimensões em milímetros

1198.C.TUB.TET torneira de teto



acionamento no arejador

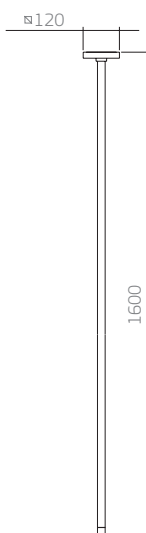

Disponibilidade do produto para venda condicionada ao prazo de fabricação.
Disponível na versão cromado.

dimensões em milímetros

1199.C.TUB.PSO
torneira de piso

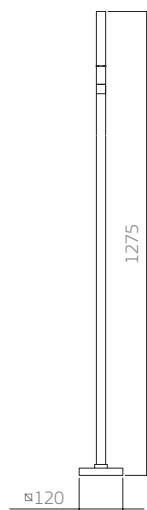
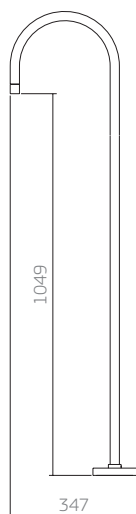

1191.C.TUB.PSO
torneira de piso

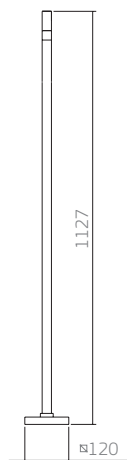
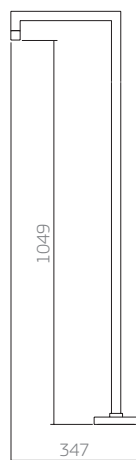

Disponibilidade do produto para venda condicionada ao prazo de fabricação.
Disponível na versão cromado.

dimensões em milímetros

1198.C.TUB
torneira lavatório mesa
para cubas de apoio



1197.C.TUB
torneira lavatório mesa

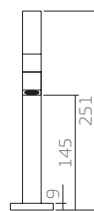
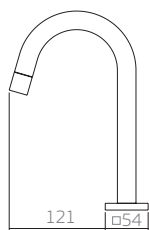

2014.C.TUB
saboneteira para torneira tube

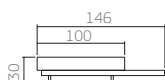

Disponível na versão cromado.

dimensões em milímetros

1877.C96
misturador lavatório mesa

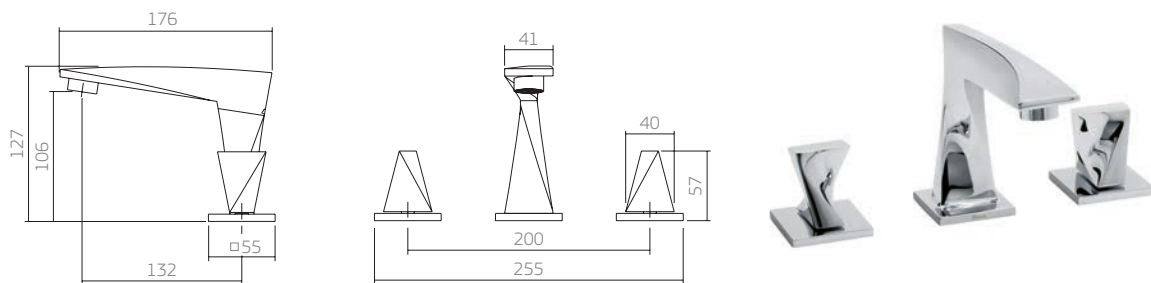

Este metal não deve ser instalado com as cubas L.90, L.903, L.71C e L.71.

1191.C96
torneira lavatório mesa

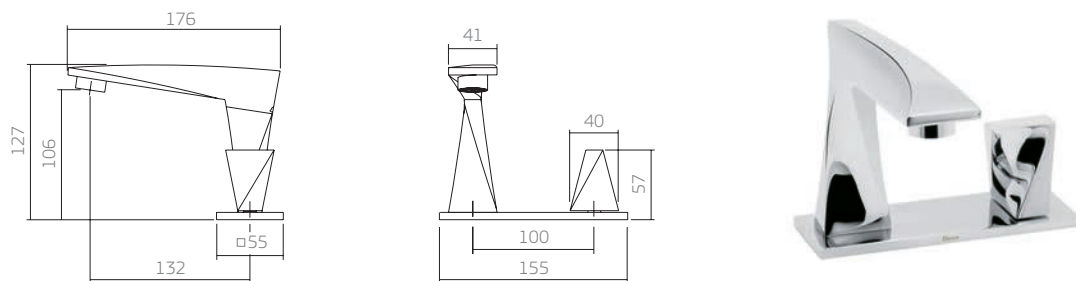

Este metal não deve ser instalado com as cubas L.90, L.903, L.71C, L.71, L.102, L.102C e L.105.

1878.C96
misturador lavatório parede

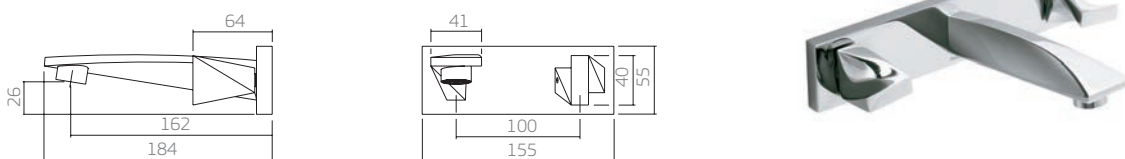

Utilizar a furação no tampo de 35mm para misturadores e torneiras de mesa.

dimensões em milímetros



C96
cromado

1179.C96
torneira lavatório parede

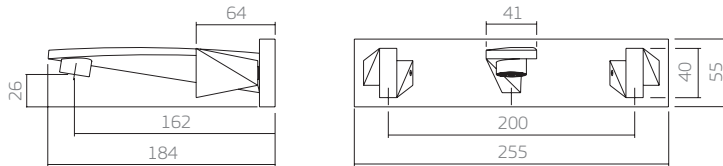

Este metal não deve ser instalado com o produto SL.01.

1984.C96.ACT.CR
ducha higiênica com
registro e derivação

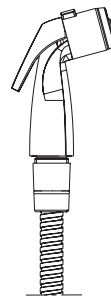
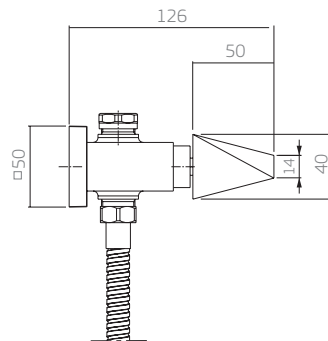

Comprimento do flexível 1,20m.

- 1895.C96 - misturador para bidê
- 1416.C96 - registro de pressão
- 1509.C96 - registro de gaveta
- 4916.C96 - acabamento para registro de pressão com mecanismo MVR (½ volta)
- 4900.C96 - acabamento para registro

dimensões em milímetros

1877.C84
misturador
lavatório mesa

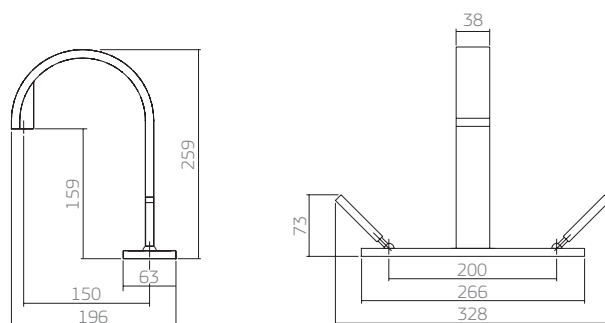

Este metal não deve ser instalado com as cubas L.90, L.903, L.71, L.71C, L.105, L.102 e L.102C.

1191.C84
torneira
lavatório mesa

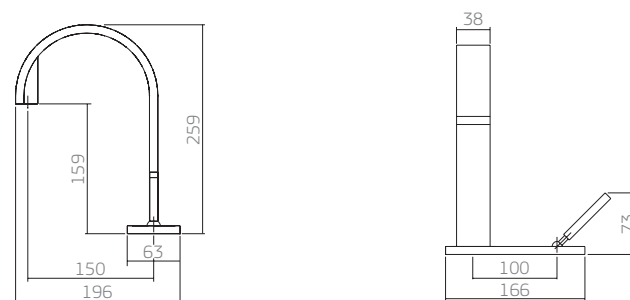

Este metal não deve ser instalado com as cubas L.90, L.903, L.71, L.71C, L.105, L.102 e L.102C.



Utilizar a furação no tampo de 35mm para misturadores e torneiras de mesa.

dimensões em milímetros

1878.C84
misturador
lavatório parede

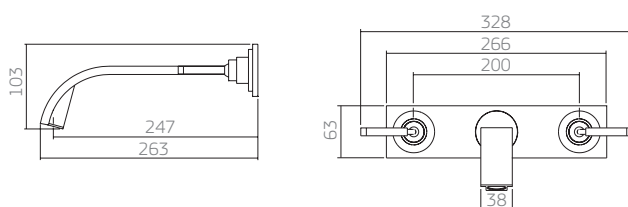

1179.C84
torneira
lavatório parede

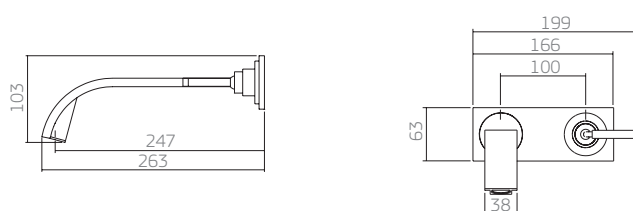

Este metal não deve ser instalado com o produto SL.01.

1984.C84.ACT.CR
ducha higiênica
com registro



Comprimento do flexível 1,20m.

- 1895.C84 - misturador para bidê
- 1416.C84 - registro de pressão
- 1509.C84 - registro de gaveta
- 4916.C84 - acabamento para registro de pressão com mecanismo MVR (½ volta)
- 4900.C84 - acabamento para registro

dimensões em milímetros

2020.C83
papeleira

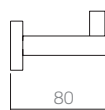
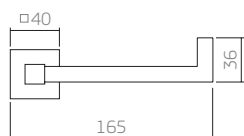

2022.C83
papeleira dupla

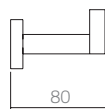
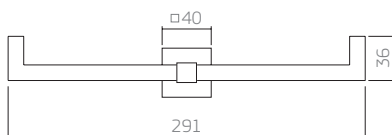

2011.C83
saboneteira parede

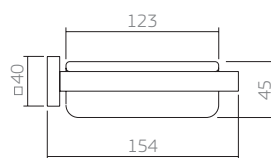
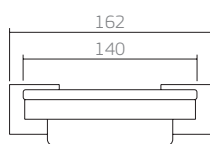

2060.C83
cabide

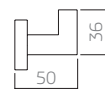
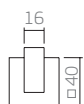

2062.C83
cabide duplo

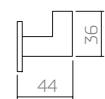
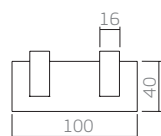

Disponível nas versões cromado, preto fosco e gold.

dimensões em milímetros

2090.C83
porta escova

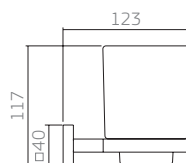

2040.C.83
porta-toalha
barra

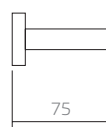

2042.C83
porta-toalha
barra dupla



2030.C83
prateleira

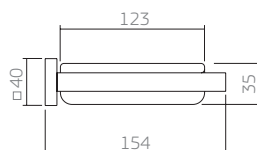
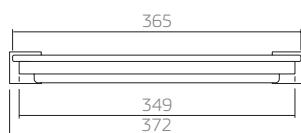

Disponível nas versões cromado, preto fosco e gold.

dimensões em milímetros

1877.C83
misturador
lavatório mesa

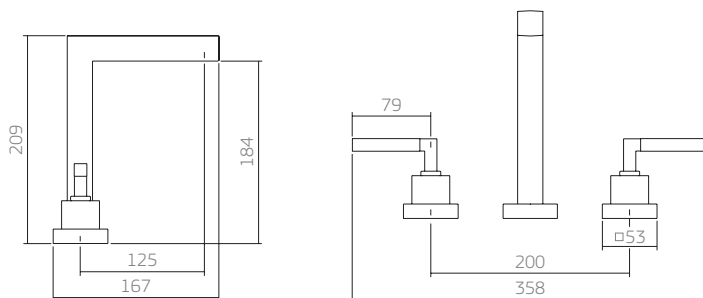

Este metal não deve ser instalado com as cubas L.90, L.903, L.71C e L.71

1878.C83
misturador lavatório parede

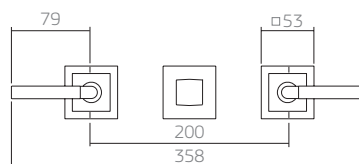
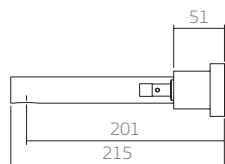

1179.C83
torneira
lavatório parede

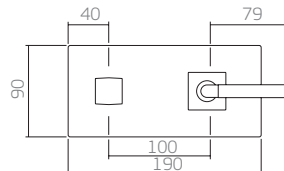
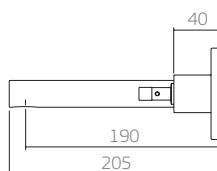

Este metal não deve ser instalado com o produto SL.01.

1984.C83.ACT.CR
ducha higiênica com
registro e derivação

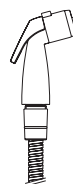
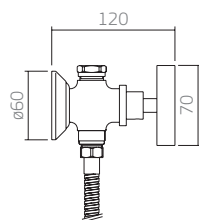

Comprimento do flexível 1,20m.



C83
cromado

1895.C83 - misturador para bidê
4916.C83 - acabamento para registro de pressão com mecanismo MVR (½ volta)
4900.C83 - acabamento para registro

dimensões em milímetros

Utilizar a furação no tampo de 35mm para misturadores e torneiras de mesa.

1877.C85
misturador
lavatório mesa

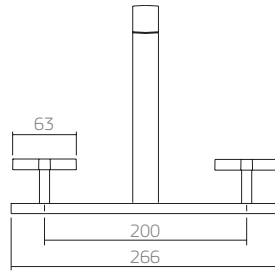
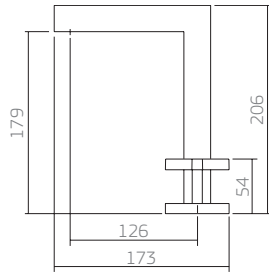

Este metal não deve ser instalado com as cubas L.90, L.903, L.71C, L.71, L.105, L.102 e L.102C.

1191.C85
torneira
lavatório mesa

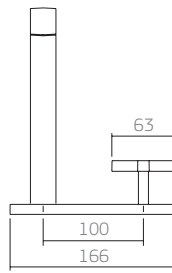
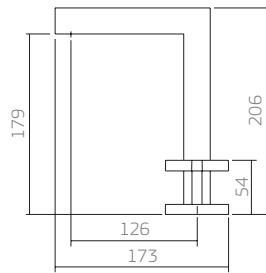

Este metal não deve ser instalado com as cubas L.90, L.903, L.71C, L.71, L.105, L.102 e L.102C.

1878.C85
misturador
lavatório parede

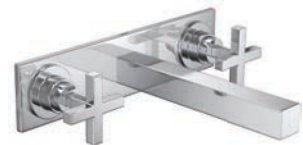
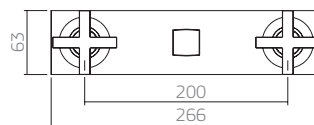
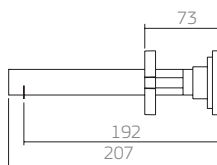

Utilizar a furação no tampo de 35mm para misturadores e torneiras de mesa.

dimensões em milímetros

1179.C85
torneira
lavatório parede

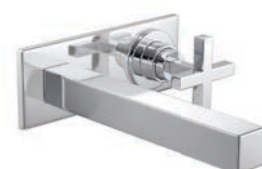
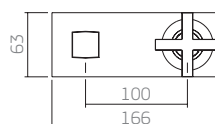
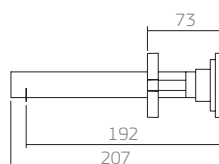

Este metal não deve ser instalado com o produto SL.01.

1984.C85.ACT.CR
ducha higiênica
com registro

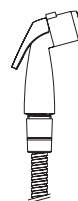
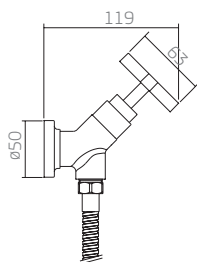

Comprimento do flexível 1,20 m.

- 1895.C85 - misturador para bidê
- 1416.C85 - registro de pressão
- 1509.C85 - registro de gaveta
- 4916.C85 - acabamento para registro de pressão com mecanismo MVR (½ volta)
- 4900.C85 - acabamento para registro

dimensões em milímetros

4248.E.FUR.ANA.BR
saboneteira com furo

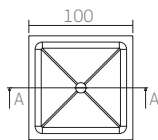
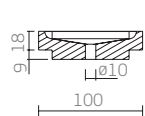

4690.E.010.ANA.BR
porta objeto

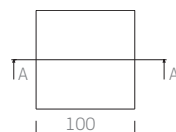
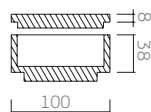

4690.E.020.ANA.BR
porta objeto

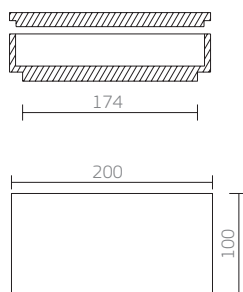
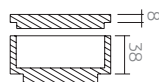

2020.C.ANA
papeleira

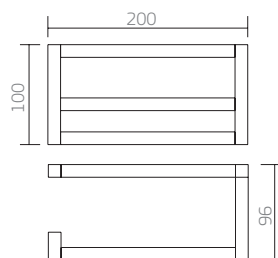
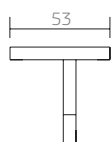

4692.E.ANA.BR
porta sabão líquido

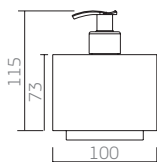

dimensões em milímetros

2043.C.ANA
porta-toalha

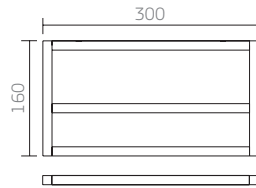

4246.E.020.ANA.BR
base prateleira

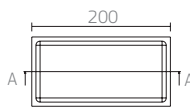
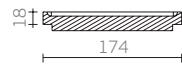

2031.C.ANA
prateleira com cabide

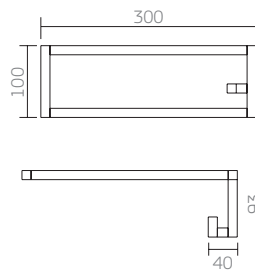
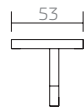

4248.E.ANA.BR
saboneteira sem furo

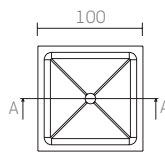

2022.C.ANA
papeleira dupla

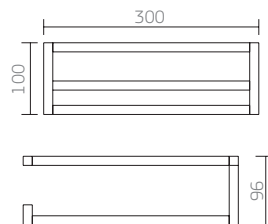
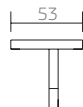

dimensões em milímetros

4246.E.030.ANA.BR
base prateleira

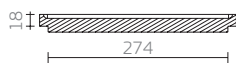

2042.C.ANA
porta-toalha barra dupla

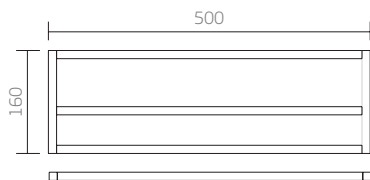

4246.E.050.ANA.BR
base prateleira

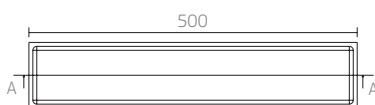

2023.C.ANA
papeleira com
revisteiro

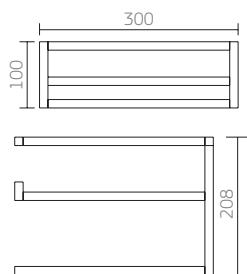
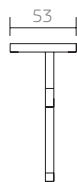

4247.E.030.ANA.BR
base prateleira
borda alta

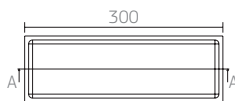

dimensões em milímetros

2021.C81
papeleira com
protetor

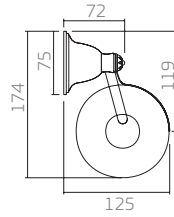
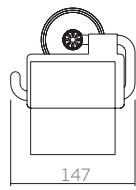

2011.C81
saboneteira parede

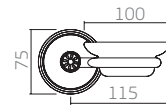
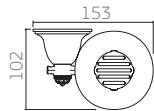

2060.C81
cabide

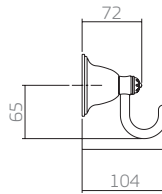
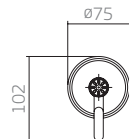

2050.C81
porta-toalha argola

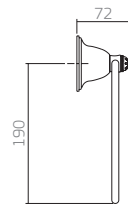
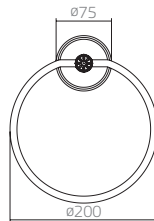

2040.C81
porta-toalha
barra

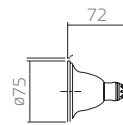

2030.C81
prateleira

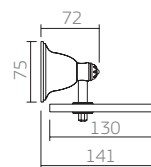
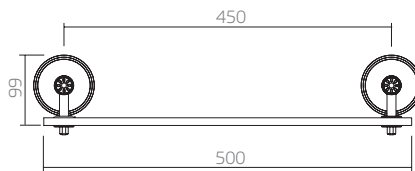

Espessura do vidro 10mm.

Disponível nas versões cromado e dourado.

dimensões em milímetros

1875.C81.P
misturador lavatório mesa
com pop-up

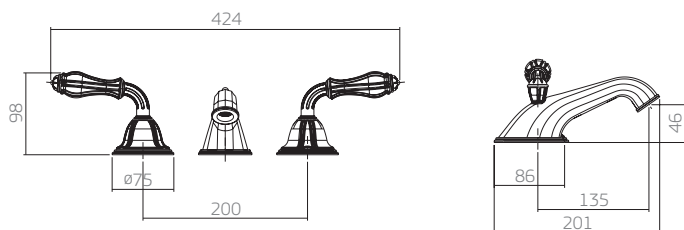

1198.C81
torneira
lavatório parede

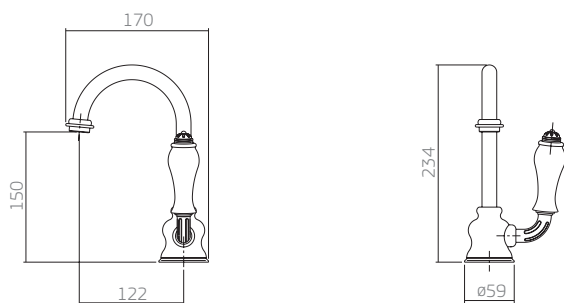

1984.C81.ACT
ducha higiênica com
registro e derivação

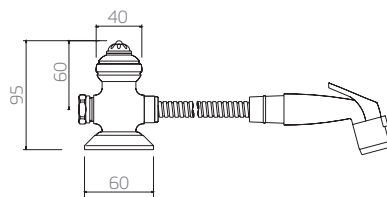

Comprimento do flexível 1,20mm



C81
cromado



D81
dourado

1895.C81 - misturador para bidê
4916.C81 - acabamento para registro de pressão com mecanismo MVR (½ volta)
4900.C81 - acabamento para registro

dimensões em milímetros

Utilizar a furação no tampo de 35mm para misturadores e torneiras de mesa.

1875.C90
misturador lavatório mesa

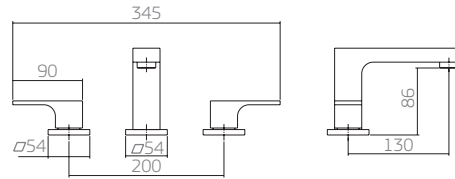

Este metal não deve ser instalado com as cubas L.90, L.903, L.71C e L.71.

1197.C90
torneira lavatório mesa

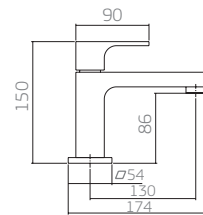

1189.C90
torneira para cuba de apoio

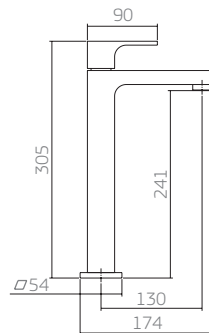

1984.C90.ACT.CR
ducha activa com
registro e derivação

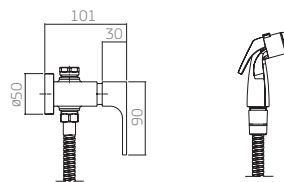

Comprimento do flexível 1,20m.



F90.PTO
preto fosco



C90
cromado



D90.GLD
gold

1895.C90 - misturador para bidê

4900.C90 - acabamento para registro

4916.C90 - acabamento para registro de pressão com mecanismo MVR (½ volta)

dimensões em milímetros

Utilizar a furação no tampo de 35mm para misturadores e torneiras de mesa.

NOVO

1877.C.WSH
misturador
lavatório mesa

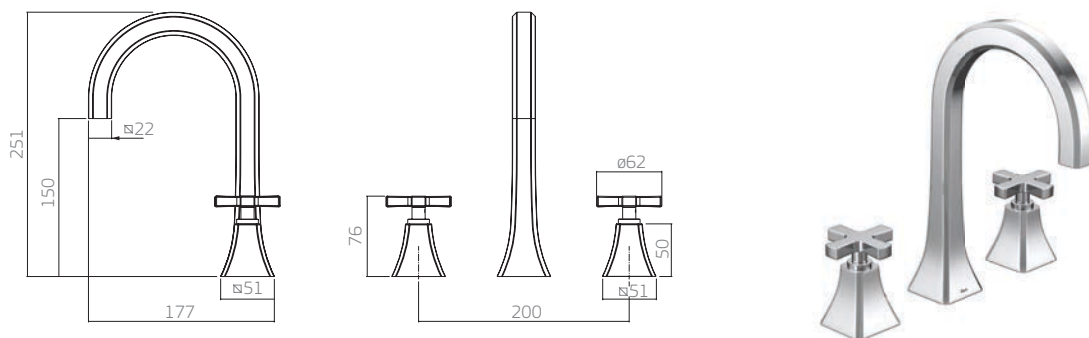

1191.C.WSH
torneira
lavatório mesa

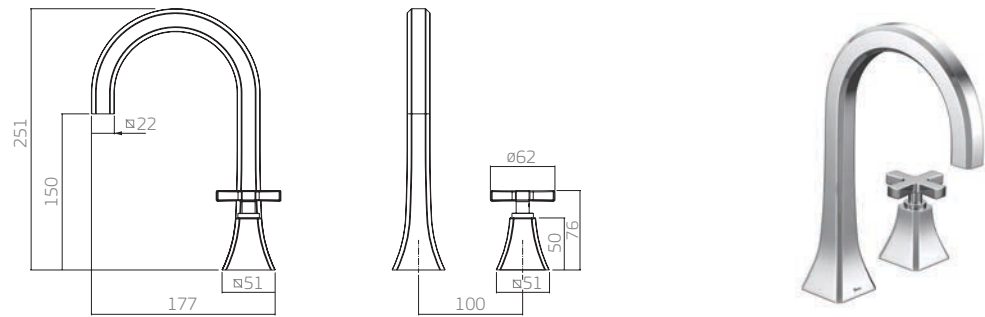

Utilizar furação no tampo de 35mm para misturadores e torneiras de mesa

dimensões em milímetros

NOVO

1878.C.WSH
misturador
lavatório parede

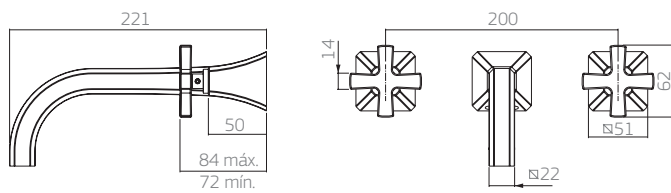

1179.C.WSH
torneira lavatório
parede

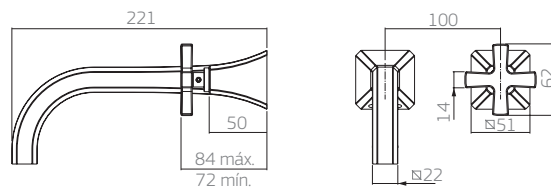

1984.C.WSH.ACT.CR
ducha higiênica com
registro e derivação

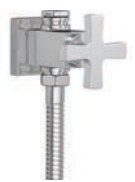
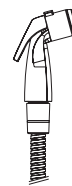
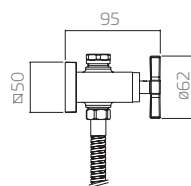

Comprimento do flexível 1,20m.

dimensões em milímetros

- 1895.C.WSH - misturador para bidê
- 4916.C.WSH - acabamento para registro de pressão com mecanismo MVR (½ volta)
- 4900.C.WSH - acabamento para registro

1175.C.TCH
torneira lavatório mesa

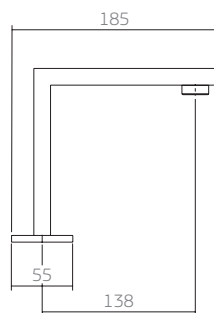
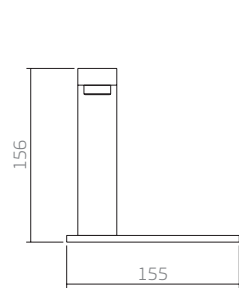

Este metal não deve ser instalado com as cubas L.102, L.102C, L.90, L.903, L.71C, L.71 e L.105.

1171.C.TCH
torneira
lavatório parede

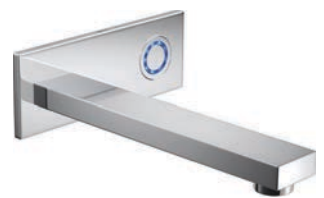
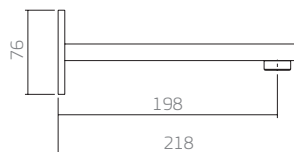
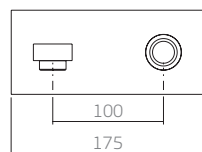

Este metal não deve ser instalado com o produto SL.01.

Disponível na versão cromado.
Possui restritor de vazão constante 6 L/min.

dimensões em milímetros

1877.C87
misturador
lavatório mesa

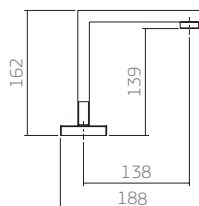
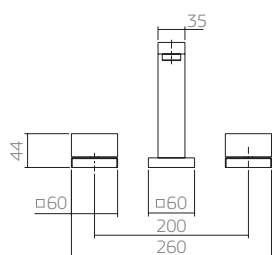

Este metal não deve ser instalado com as cubas L.90, L.903, L.71C e L.71.

1191.C87*
torneira
lavatório mesa

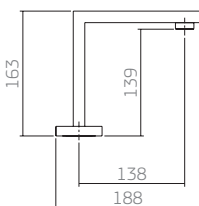
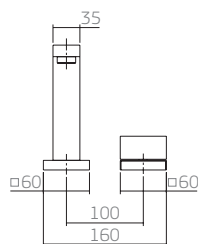

Este metal não deve ser instalado com as cubas L.90, L.903, L.71C e L.71.

1878.C87
misturador
lavatório parede

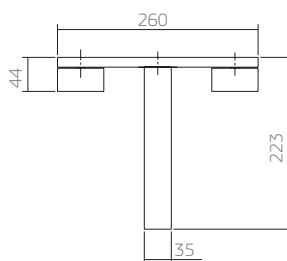
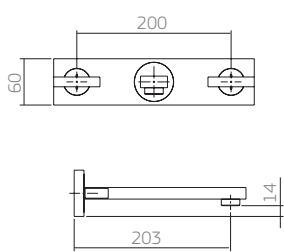

dimensões em milímetros



F87.PTO
preto fosco



C87
cromado



D87.GLD
gold

Utilizar a furação no tampo de 35mm para misturadores e torneiras de mesa.

1179.C87
torneira lavatório
embutida parede

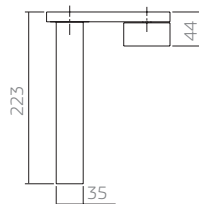
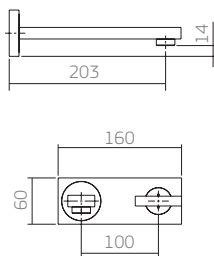

A instalação pode ser feita nas posições: vertical, horizontal ou diagonal.
Este metal não deve ser instalado com o produto SL01.

1984.C87.ACT.CR
ducha higiênica com
registro e derivação

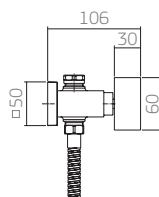

Comprimento do flexível 1,20m.

- 1895.C87 - misturador para bidê
- 1416.C87 - registro de pressão
- 1509.C87 - registro de gaveta
- 4916.C87 - acabamento para registro de pressão com mecanismo MVR (½ volta)
- 4900.C87 - acabamento para registro

144 METAIS

dimensões em milímetros

1877.C88
misturador
lavatório mesa

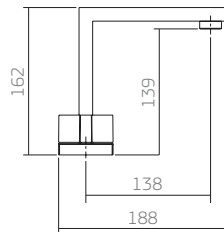
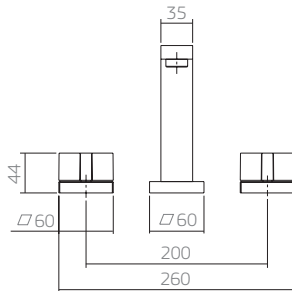

Este metal não pode ser instalado com as cubas L.90, L.903, L.71C e L.71.

1191.C88
torneira
lavatório mesa

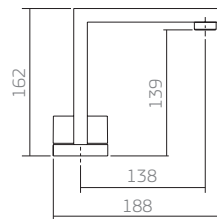
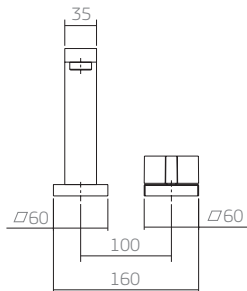

Este metal não pode ser instalado com as cubas L.90, L.903, L.71C e L.71.

1878.C88
misturador
lavatório parede

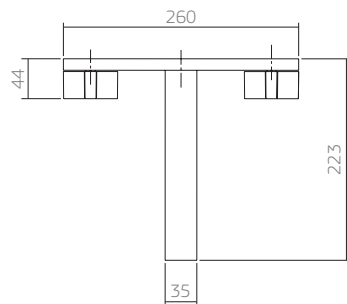
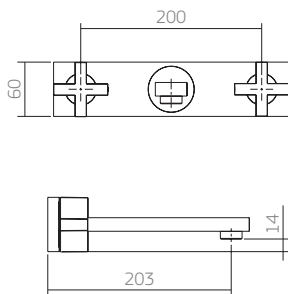

Utilizar a furação no tampo de 35mm para misturadores e torneiras de mesa.

dimensões em milímetros

1179.C88
torneira lavatório
embutida parede

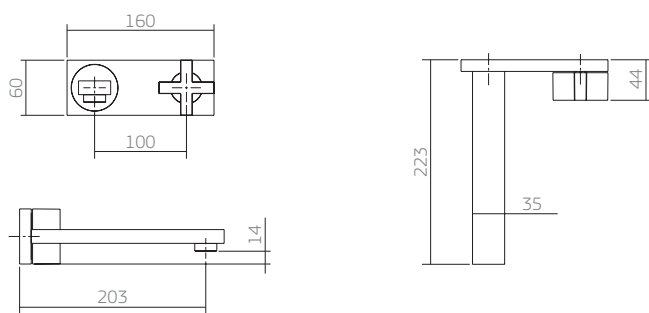

A instalação pode ser feita nas posições: vertical, horizontal ou diagonal.
Este metal não pode ser instalado com o produto SL.01.

1984.C88.ACT.CR
ducha higiênica com
registro e derivação

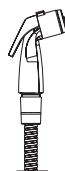
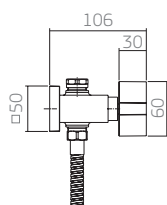

Comprimento do flexível 1,20m.

- 1895.C88 - misturador para bidê
- 1416.C88 - registro de pressão
- 1509.C88 - registro de gaveta
- 4900.C88 - acabamento para registro
- 4916.C88 - acabamento para registro de pressão com mecanismo MVR (1/2 volta)

dimensões em milímetros

2021.C67
papeleira com protetor

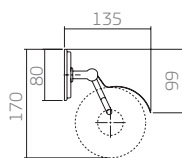
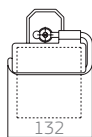

2011.C67
saboneteira parede

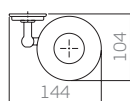
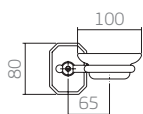

2060.C67
cabide

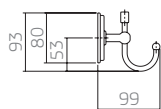

2050.C67
porta-toalha argola

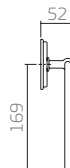
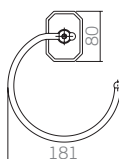

2040.C67
porta-toalha barra

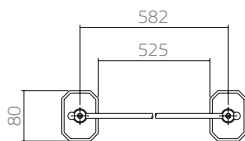

2030.C67
prateleira

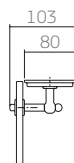
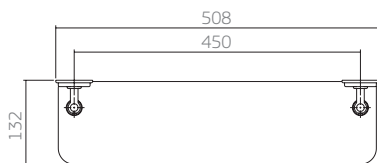

Disponível nas versões cromado e dourado.

dimensões em milímetros

1875.C67
misturador
mesa

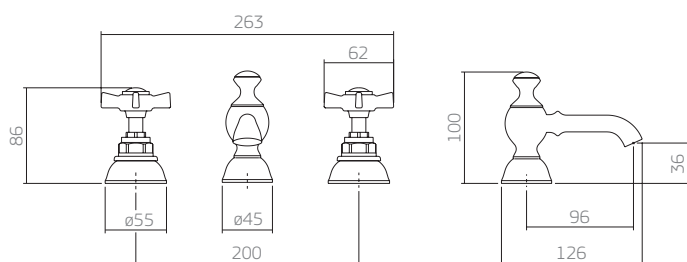

1875.C67.EXT
misturador
lavatório mesa

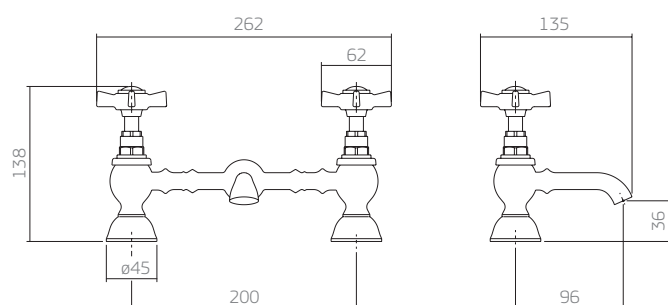

1197.C67
torneira
lavatório mesa

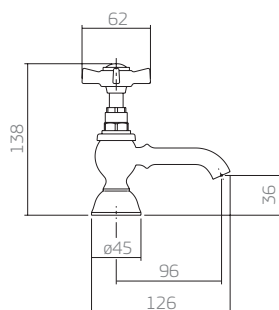

C67
cromado



D67
dourado

Utilizar a furação no tampo de 35mm para misturadores e torneiras de mesa.

dimensões em milímetros

1198.C67
torneira
lavatório mesa

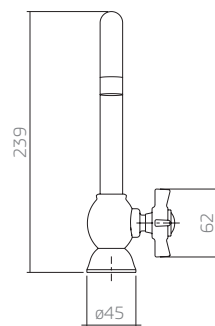
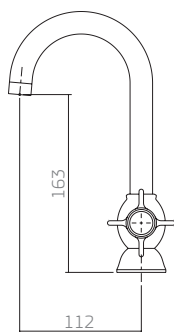

1984.C67.ACT.CR
ducha higiênica com
registro e derivação

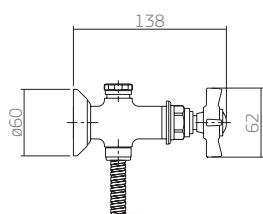

Comprimento do flexível 1,20m.

- 1895.C67 - misturador para bidê
- 4916.C67 - acabamento para registro de pressão com mecanismo MVR (1/2 volta)
- 4900.C67 - acabamento para registro

dimensões em milímetros

1877.C95
misturador
lavatório mesa

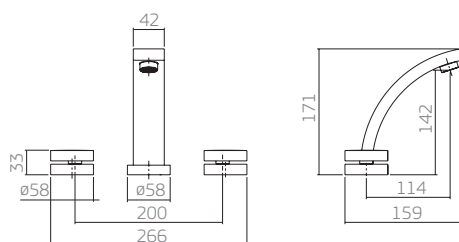

1191.C95
torneira
lavatório mesa

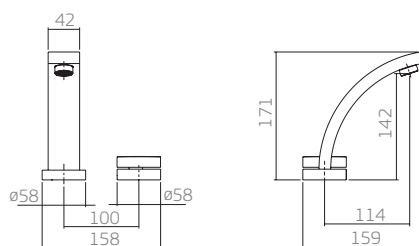

1878.C95
misturador
lavatório parede

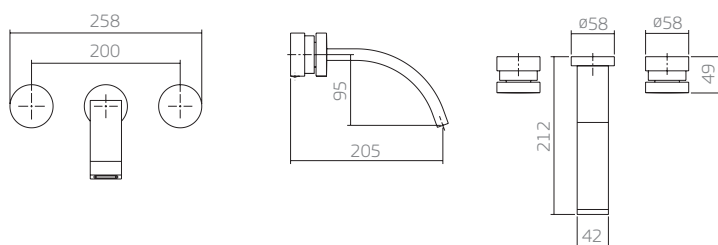

Utilizar a furação no tampo de 35mm para misturadores e torneiras de mesa.

dimensões em milímetros

1179.C95
torneira
lavatório parede

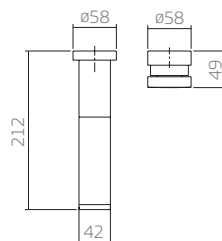
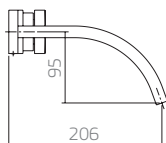
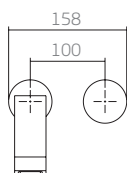

1984.C95.ACT.CR
ducha higiênica
com registro

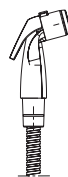
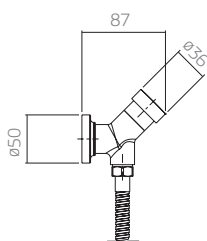

Comprimento do flexível 1,20m.

- 1895.C95 - misturador para bidê
1416.C95 - registro de pressão
1509.C95 - registro de gaveta
4916.C95 - acabamento para registro depressão com mecanismo MVR (½ volta)
4900.C95 - acabamento para registro

dimensões em milímetros

1877.C73
misturador
lavatório mesa

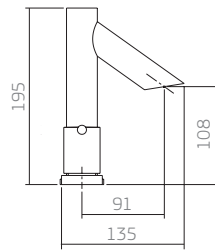
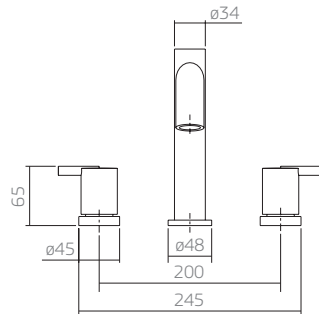

Este metal não pode ser instalado com as cubas L.86, L.87, L.88, L.863 e L.873.

1196.C73
torneira
lavatório mesa

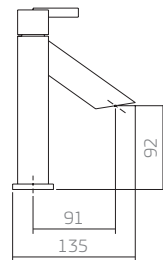
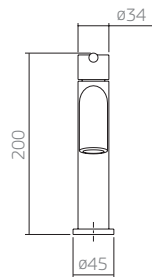

Este metal não pode ser instalado com as cubas L.86, L.87, L.88, L.863 e L.873.

1878.C73
misturador lavatório parede

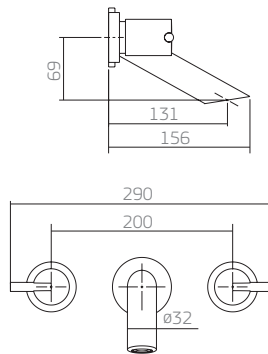
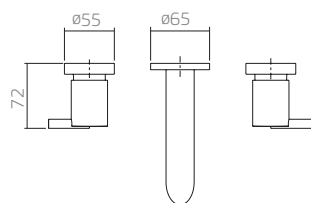

Utilizar a furação no tampo de 35mm para misturadores e torneiras de mesa.

dimensões em milímetros

1179.C73
torneira lavatório parede

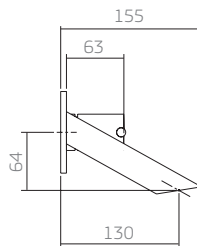
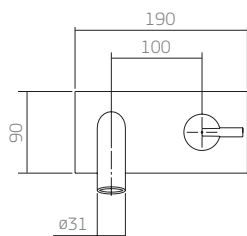

Este metal não pode ser instalado com o produto SL.01.

1984.C73.ACT.CR
ducha higiênica com
registro de derivação

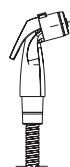
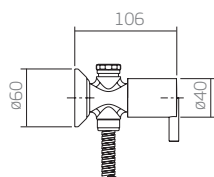

Comprimento do flexível 1,20m.

1895.C73 - misturador para bidê
4916.C73 - acabamento para registro de pressão com mecanismo MVR (1/2 volta)
4900.C73 - acabamento para registro

dimensões em milímetros

1875.C89
misturador
lavatório mesa

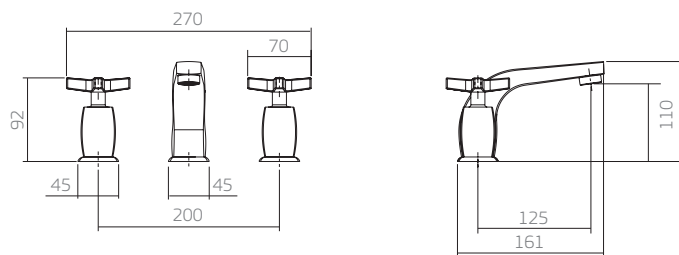

1197.C89
torneira lavatório mesa

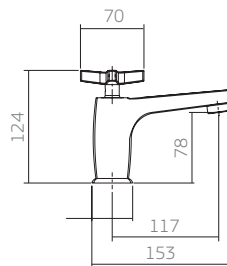

1984.C89.ACT.CR
ducha higiênica
com registro

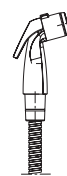
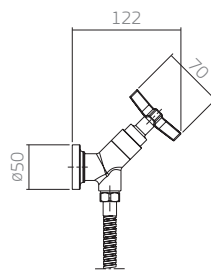

Comprimento do flexível 1,20m.



1895.C89 - misturador para bidê
4916.C89 - acabamento para registro depressão com mecanismo MVR (1/2 volta)
4900.C89 - acabamento para registro

dimensões em milímetros

Utilizar a furação no tampo de 35mm para misturadores e torneiras de mesa.

1878.C94
misturador lavatório parede

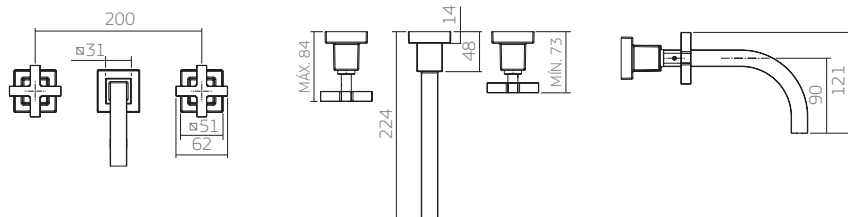

1178.C94
torneira
lavatório parede

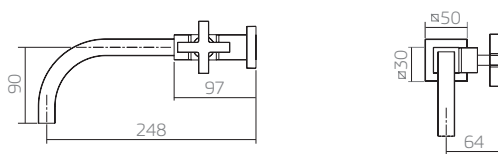

1179.C94
torneira
lavatório parede

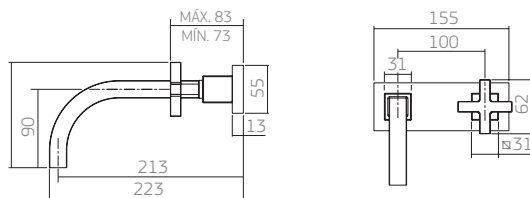

Este metal não deve ser instalado com o produto SL.01.

1984.C94.ACT.CR
ducha higiênica com
registro derivação

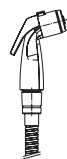

Comprimento do flexível 1,20m.



1895.C94 - misturador para bidê
4900.C94 - acabamento para registro
4916.C94 - acabamento para registro de pressão com mecanismo MVR (½ volta)

dimensões em milímetros

1877.C86
misturador lavatório mesa

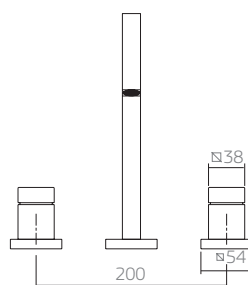
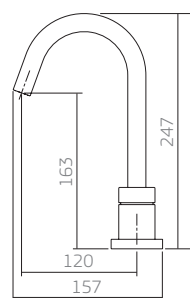

Este metal não deve ser instalado com as cubas L.90, L.903, L.71C e L.71.

1191.C86
torneira lavatório mesa

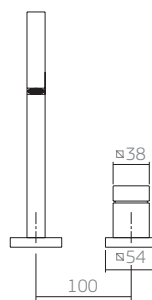
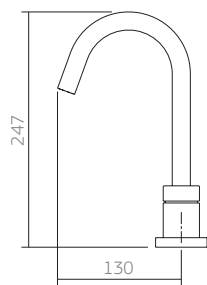

Este metal não deve ser instalado com as cubas L.90, L.903, L.71C e L.71.



C86
cromado

Utilizar a furação no tampo de 35mm para misturadores e torneiras de mesa.

dimensões em milímetros

1878.C86
misturador lavatório
parede

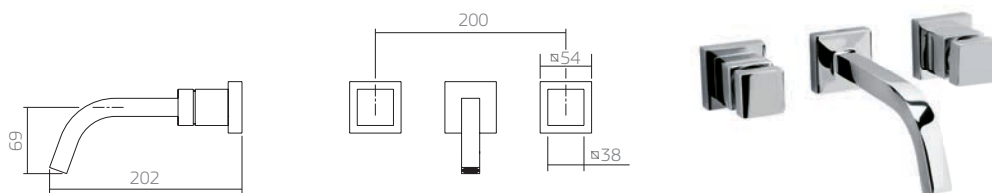

1179.C86
torneira lavatório
parede

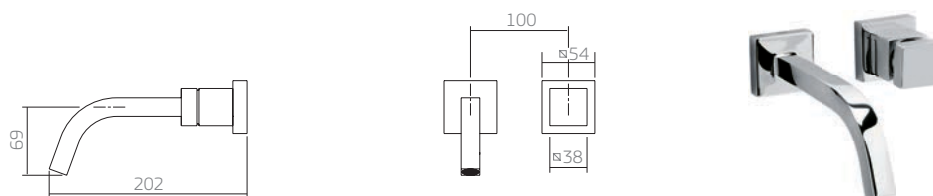

1984.C86.ACT.CR
ducha higiênica com
registro e derivação

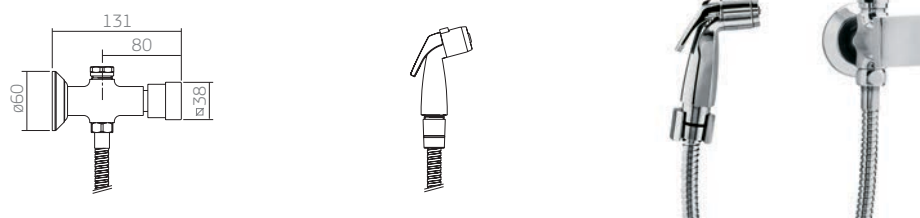

Comprimento do flexível 1,20m.

1895.C86 misturador para bidê
4916.C86 acabamento para registro de pressão com mecanismo MVR (½ volta)
4900.C86 acabamento para registro

dimensões em milímetros

1877.C61
misturador
lavatório mesa

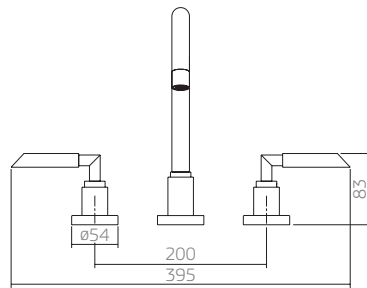
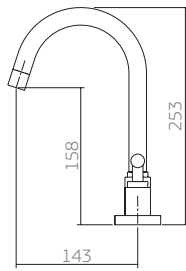

1198.C61
torneira
lavatório mesa

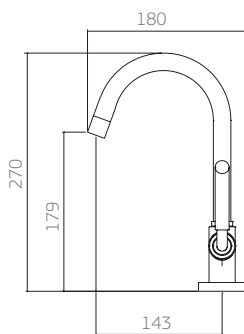

4690.C
prolongador para
torneiras



Compatível com torneiras de mesa das linhas Duna e Duna Clássica.

1984.C61.ACT.CR
ducha higiênica com
registro e derivação

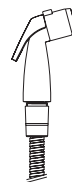
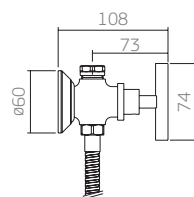

Comprimento do flexível 1,20m.



C61
cromado

1895.C61 - misturador para bidê
4916.C61 - acabamento para registro de pressão com mecanismo MVR (½ volta)
4900.C61 - acabamento para registro

dimensões em milímetros

Utilizar a furação no tampo de 35mm para misturadores e torneiras de mesa.

1877.C64
misturador
lavatório mesa

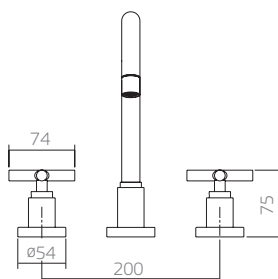
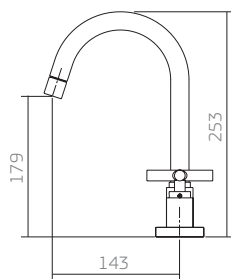

1197.C64
torneira lavatório mesa

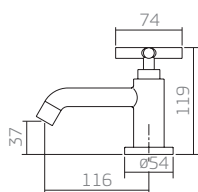

1198.C64
torneira lavatório mesa

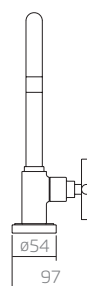
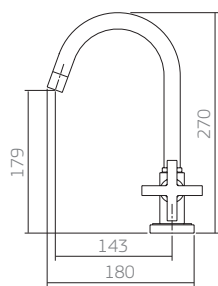

1878.C64
misturador lavatório parede

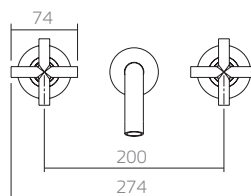
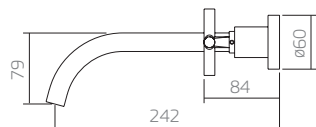

Sugerimos utilizar acessórios da linha Duna.

dimensões em milímetros

Utilizar a furação no tampo de 35mm para misturadores e torneiras de mesa.



1178.C64
torneira lavatório parede

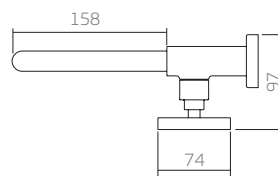
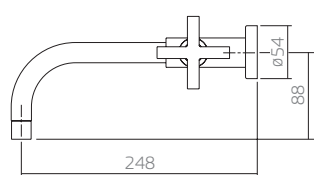

1174.C64
torneira lavatório
parede curta

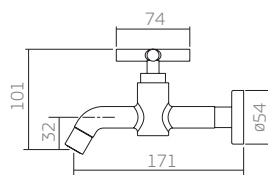

1984.C64.ACT.CR
ducha higiênica com
registro e derivação

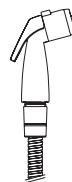
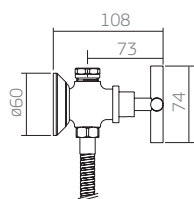

Comprimento do flexível 1,20m.

1895.C64 - misturador para bidê
4916.C64 - acabamento para registro de pressão com mecanismo MVR (1/2 volta)
4900.C64 - acabamento para registro

dimensões em milímetros

Sugerimos utilizar acessórios da linha Duna.

1877.C.STR
misturador lavatório mesa

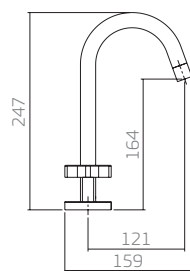
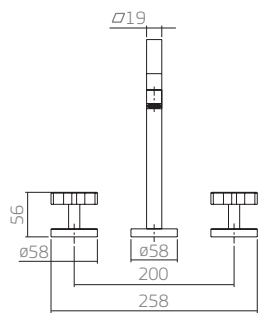

1198.C.STR
torneira lavatório mesa

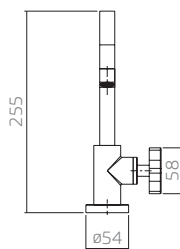
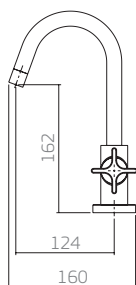

1197.C.STR
torneira lavatório mesa

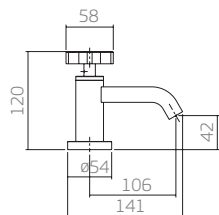

Utilizar a furação no tampo de 35mm para misturadores e torneiras de mesa.

dimensões em milímetros



C.STR
cromado

1878.C.STR
misturador lavatório parede

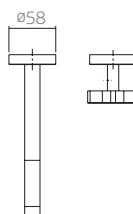
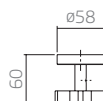
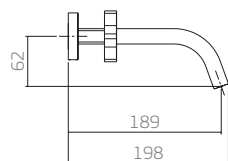
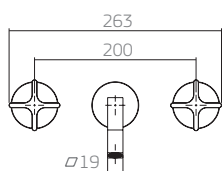

1984.C.ACT.STR
ducha higiênica com registro e derivação

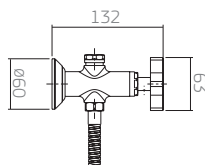

Comprimento do flexível 1,20m.

1895.C.STR - misturador para bidê
4916.C.STR - acabamento para registro de pressão com mecanismo MVR (½ volta)
4900.C.STR - acabamento para registro

dimensões em milímetros

1877.C72
misturador lavatório mesa

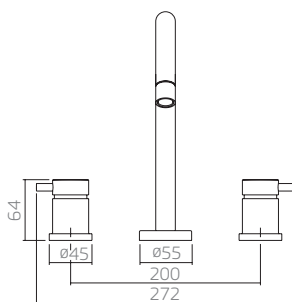
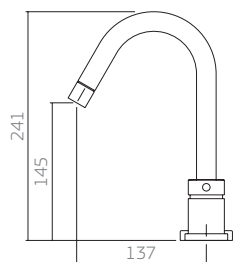

1198.C72
torneira lavatório mesa

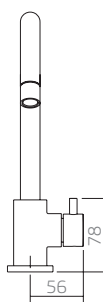
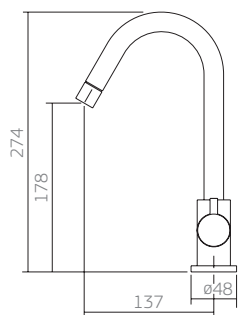

Utilizar a furação no tampo de 35mm para misturadores e torneiras de mesa.

dimensões em milímetros

1878.C72
misturador lavatório
parede

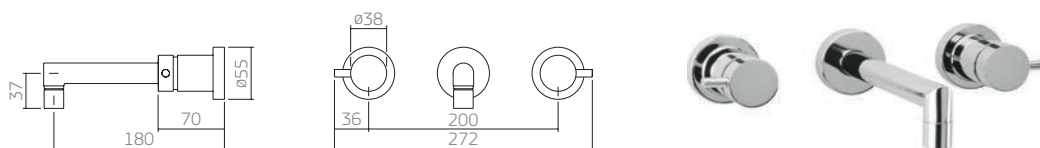

1179.C72
torneira lavatório parede

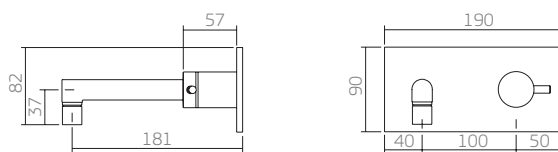

Este metal não deve ser instalado com o produto SL.01.

1984.C72.ACT
ducha higiênica com
registro e derivação

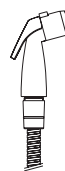
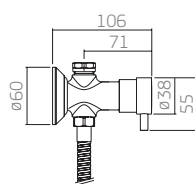

Comprimento do flexível 1,20m.

1895.C72 - misturador para bidê
4916.C72 - acabamento para registro de pressão com mecanismo MVR (1/2 volta)
4900.C72 - acabamento para registro

dimensões em milímetros

2020.C.SLM
papeleira

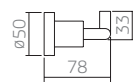
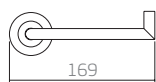

2022.C.SLM
papeleira dupla

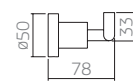
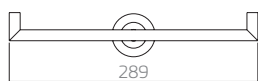

2011.C.SLM
saboneteira parede

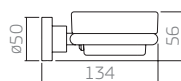

2060.C.SLM
cabide

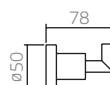

2090.C.SLM
porta-escova

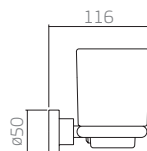
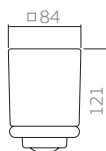

2050.C.SLM
porta-toalha argola

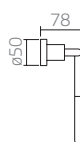

Disponível nas versões cromado, preto fosco e dourado.

dimensões em milímetros

2040.C.SLM
porta-toalha barra

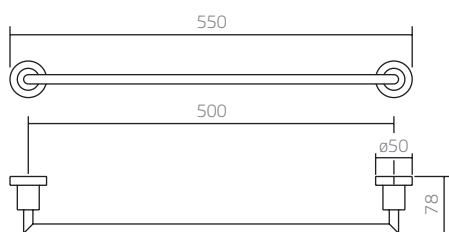

2042.C.SLM
porta-toalha barra dupla

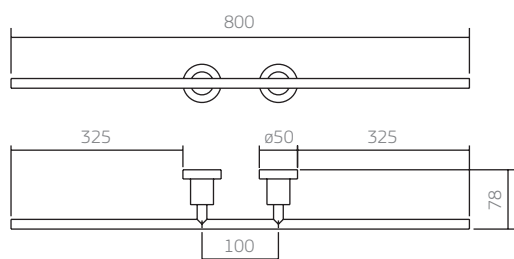

2030.C.SLM
prateleira

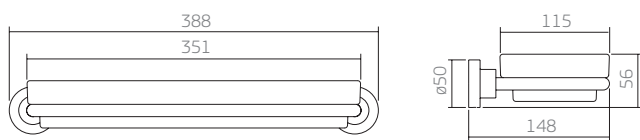

Disponível nas versões cromado, preto fosco e dourado.

dimensões em milímetros

SABONETEIRA DE APOIO

2012.C
saboneteira de apoio

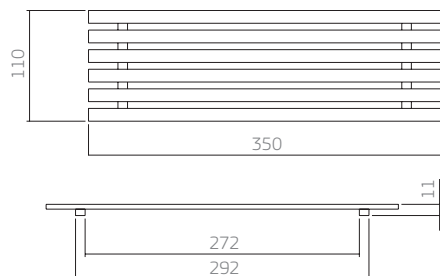

Sugestão de uso: cubas especiais L.86, L.87, L.88, L.863, L.873 e L.870.

Disponível na versão cromado.

dimensões em milímetros

- Acionamento com um suave toque.
- Indicação de temperatura através de LED luminoso (gradativo de azul a vermelho).
- Programação para até dois perfis de usuários.

2875.C.TCH
monocomando mesa

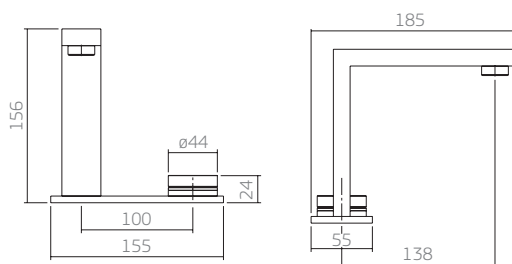

Este metal não deve ser instalado com as cubas L.102, L.102C, L.90, L.903, L.71, L.71C e L.105.

2993.C.TCH
monocomando para
chuveiro de alta pressão

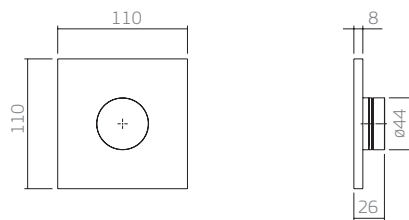

2993.C.TCH.CON
monocomando para
chuveiro, com controle
remoto alta pressão

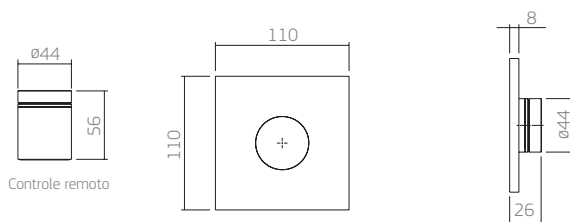

Controle remoto

Disponível na versão cromado.
Recomendável com pressão mínima de 10 m.c.a.
Tensão de funcionamento: bivolt.
Este produto exige instalações elétricas próprias.

dimensões em milímetros

2885.C90
monocomando mesa

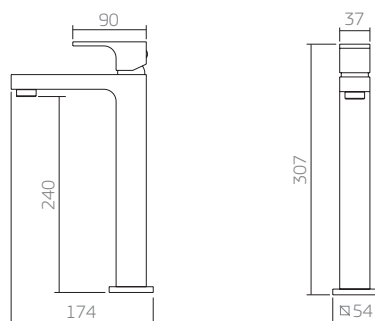

Recomendável com pressão mínima de 18 m.c.a para aquecedor de passagem e de 4 m.c.a para aquecedor de acumulação.

2875.C90
monocomando mesa

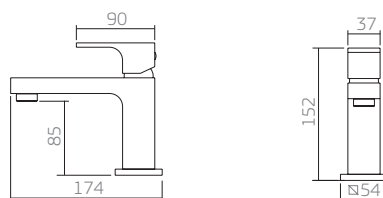

Recomendável com pressão mínima de 18 m.c.a para aquecedor de passagem e de 4 m.c.a para aquecedor de acumulação.

2885.C90.CAS
monocomando mesa

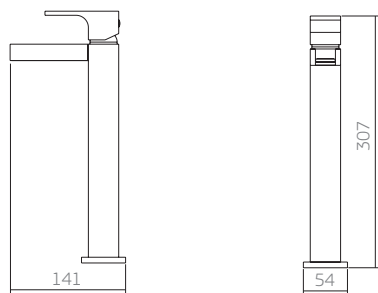

Recomendável com pressão mínima de 10 m.c.a para aquecedor de passagem e de 4 m.c.a para aquecedor de acumulação.
Disponível nas versões cromado e gold.



dimensões em milímetros

2875.C90.CAS
monocomando mesa

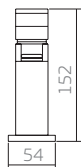
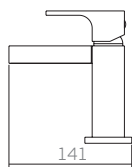

Recomendável com pressão mínima de 10 m.c.a para aquecedor de passagem e de 4 m.c.a para aquecedor de acumulação.
Disponível nas versões cromado e gold.

2993.C90.034
monocomando para chuveiro
baixa e alta pressão

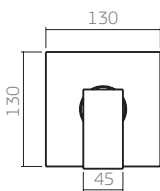

Disponível na versão cromado.

2994.C90
monocomando para
chuveiro com desviador
para banheira

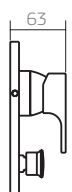
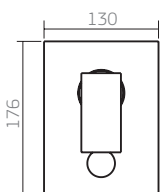

Disponível na versão cromado.

4993.C90.ACT - acabamento monocomando para ducha higiênica BAIXA E ALTA PRESSÃO
4993.C90.CHU - acabamento monocomando para chuveiro BAIXA E ALTA PRESSÃO

dimensões em milímetros

2878.C73
monocomando parede

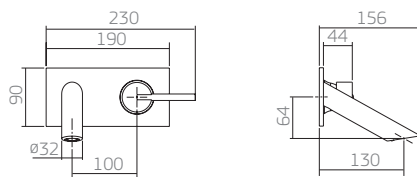

Este metal não deve ser instalado com o produto SL.01.

2885.C73
monocomando mesa

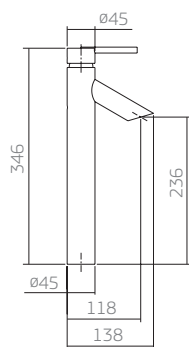

Utilizar a furação no tampo de 35mm para misturadores e torneiras de mesa.

dimensões em milímetros

2895.C73
monocomando para bidê

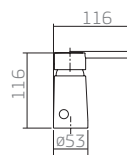

2875.C73
monocomando mesa

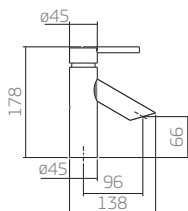

2993.C73.034
monocomando para chuveiro
baixa e alta pressão

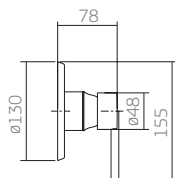

- 4900.C73. - acabamento para registro
 4916.C73.PQ.CR - acabamento para registro
 4993.C73.ACT - acabamento monocomando para ducha baixa e alta pressão
 4993.C73.CHU - acabamento monocomando para chuveiro baixa e alta pressão

dimensões em milímetros

2875.C79.CR
monocomando
lavatório mesa

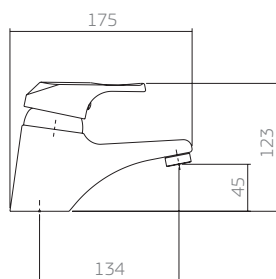

Recomendável com pressão mínima de 6 m.c.a para aquecedor de passagem e de 2 m.c.a para aquecedor de acumulação.

2993.C79.034.CR
monocomando para chuveiro
baixa e alta pressão

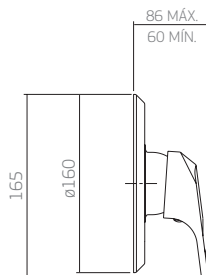

C79.CR
cromado

4493.C79.CHU.CR - acabamento monocomando para chuveiro BAIXA E ALTA PRESSÃO
4993.C79.ACT.CR - acabamento monocomando para ducha higiênica BAIXA E ALTA PRESSÃO

dimensões em milímetros

2875.C49
monocomando lavatório mesa

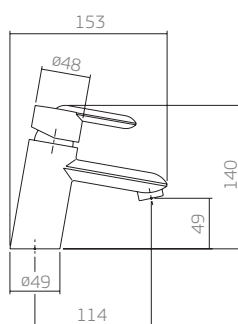

Diâmetro do furo de tampo para lavatório 37mm.

Recomendável com pressão mínima de 6 m.c.a para aquecedor de passagem e de 2 m.c.a para aquecedor de acumulação.

2895.C49
monocomando para bidê

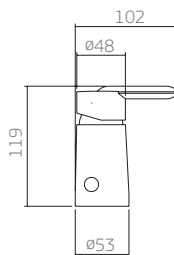

Recomendável com pressão mínima de 6 m.c.a para aquecedor de passagem e de 2 m.c.a para aquecedor de acumulação.

2993.C49.034
monocomando para chuveiro
baixa e alta pressão

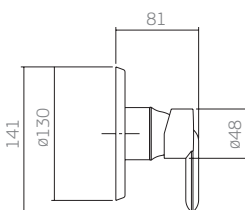

C49
cromado

- 4900.C49 - acabamento para registro
- 4993.C49.CHU - acabamento monocomando para chuveiro BAIXA E ALTA PRESSÃO
- 4993.C49.ACT - acabamento monocomando para ducha higiênica BAIXA E ALTA PRESSÃO

dimensões em milímetros

2875.C36
monocomando lavatório mesa

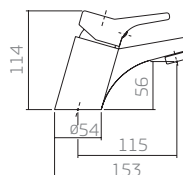

Diâmetro do furo de tampo para lavatório 37mm.

Recomendável com pressão mínima de 6 m.c.a para aquecedor de passagem e de 2 m.c.a para aquecedor de acumulação.



2895.C36
monocomando para bidê

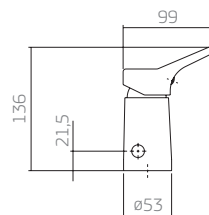

Recomendável com pressão mínima de 6 m.c.a para aquecedor de passagem e de 2 m.c.a para aquecedor de acumulação.



2993.C36.034
monocomando para chuveiro
baixa e alta pressão

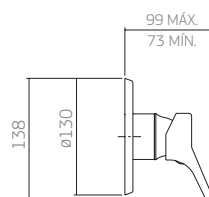

2994.C36
monocomando para chuveiro
com desviador

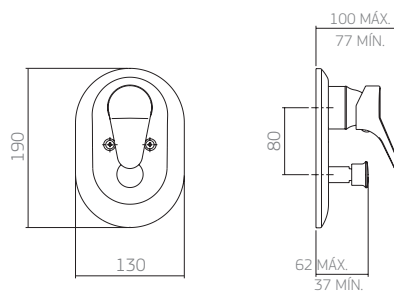

4993.C36.CHU - acabamento monocomando para chuveiro BAIXA E ALTA PRESSÃO
4493.C36.ACT - acabamento monocomando para ducha higiênica BAIXA E ALTA PRESSÃO

dimensões em milímetros

2886.C.LNK
monocomando lavatório
mesa tubo 90°

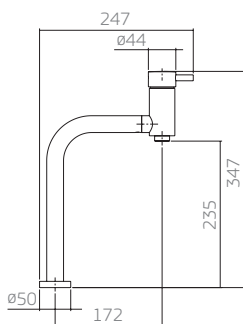

Recomendável com pressão mínima de 10 m.c.a para aquecedor de passagem e de 2 m.c.a para aquecedor de acumulação.

2885.C.LNK
monocomando lavatório
mesa bica alta

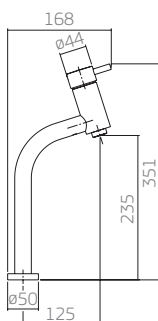

Recomendável com pressão mínima de 10 m.c.a para aquecedor de passagem e de 2 m.c.a para aquecedor de acumulação.

2875.C.LNK
monocomando lavatório
mesa bica baixa

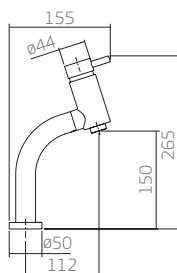

Recomendável com pressão mínima de 10 m.c.a para aquecedor de passagem e de 2 m.c.a para aquecedor de acumulação.



C.LNK
cromado

4900.C.PQ.LNK / 4900.C.GD.LNK - acabamento para registro

Diâmetro dos furos de tampo para lavatório 37mm.

dimensões em milímetros

2875.C71
monocomando
lavatório mesa

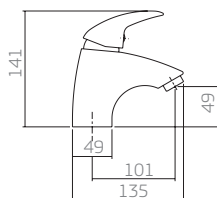

Diâmetro dos furos de tampo para lavatório 37mm.
Recomendável com pressão mínima de 6 m.c.a para aquecedor de passagem e de 2 m.c.a para aquecedor de acumulação.

2895.C71
monocomando para bidê

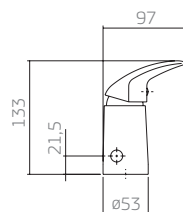

Recomendável com pressão mínima de 6 m.c.a para aquecedor de passagem e de 2 m.c.a para aquecedor de acumulação.

1984.C71.ACT
ducha higiênica com registro e
derivação e mecanismo (MVS) 3 ½

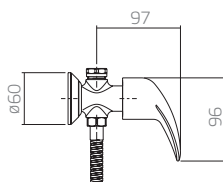

Comprimento do flexível 1,20m.
Recomendável com pressão mínima de 6 m.c.a para aquecedor de passagem e de 2 m.c.a para aquecedor de acumulação.



C71
cromado

dimensões em milímetros

2993.C71.034
monocomando para chuveiro
baixa e alta pressão

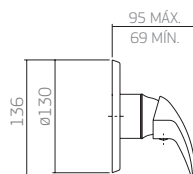

Recomendável com pressão mínima de 6 m.c.a para aquecedor de passagem e de 2 m.c.a para aquecedor de acumulação

2994.C71
monocomando para chuveiro,
com desviador baixa e alta pressão

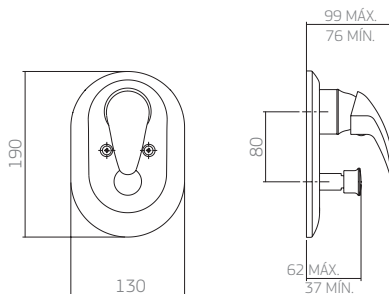

Recomendável com pressão mínima de 6 m.c.a para aquecedor de passagem e de 2 m.c.a para aquecedor de acumulação

4900.C71 - acabamento para registro
4993.C71.CHU - acabamento monocomando para chuveiro BAIXA E ALTA PRESSÃO
4993.C71.ACT - acabamento monocomando para ducha higiênica BAIXA E ALTA PRESSÃO

dimensões em milímetros

1877.C25
misturador lavatório

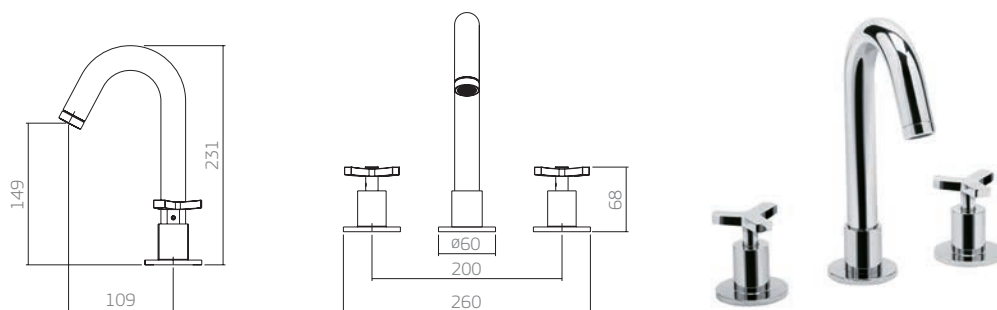

1197.C25
torneira
lavatório mesa

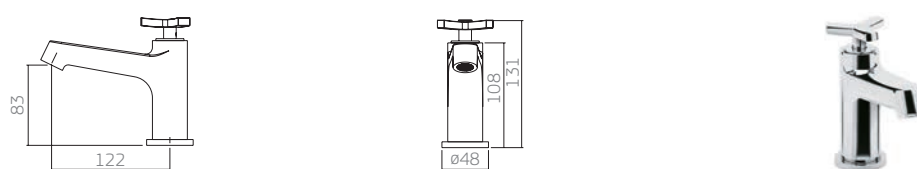

1198.C25
torneira
lavatório mesa

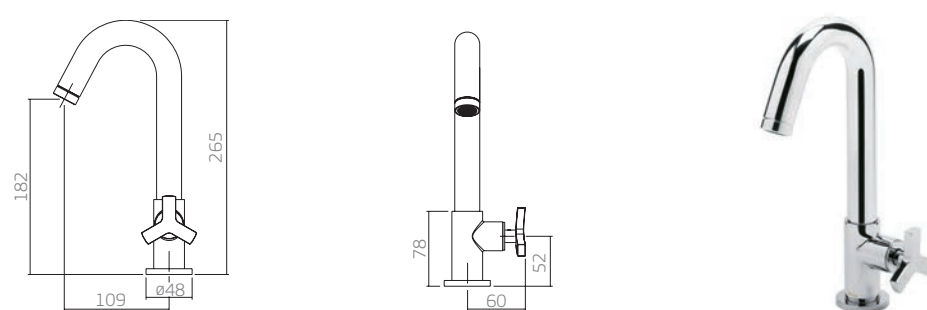

1878.C25
misturador
lavatório parede

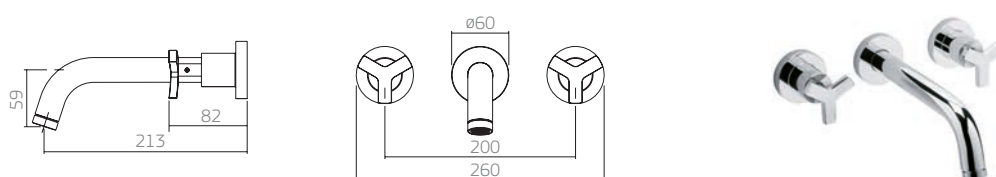

Utilizar a furação no tampo de 35mm para misturadores e torneiras de mesa.

dimensões em milímetros



1178.C25
torneira lavatório parede

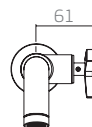
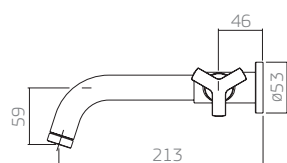

1179.C25
torneira lavatório parede

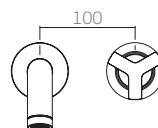
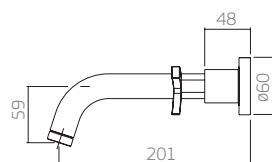

A instalação pode ser feita nas posições: vertical, horizontal e diagonal.

1984.C25.ACT.BR
ducha higiênica com registro,
derivação e gatilho branco

1984.C25.ACT.CR
ducha higiênica com registro,
derivação e gatilho cromado

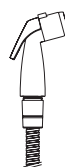
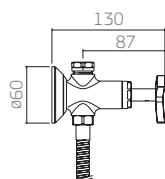

Comprimento de flexível 1,20m.

- 1895.C25 - misturador para bidê
- 4900.C25 - acabamento para registro
- 4916.C25 - acabamento para registro de pressão com mecanismo MVR (1/2 volta)

dimensões em milímetros



2020.C33
papeleira

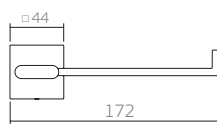
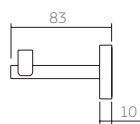

2010.C33
saboneteira

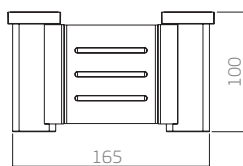
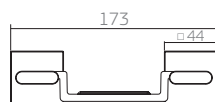

2060.C33
cabide

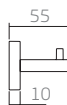

2040.C33.020
porta-toalha barra

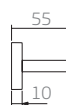

Disponível na versão cromado.

dimensões em milímetros



2040.C33.030
porta-toalha barra

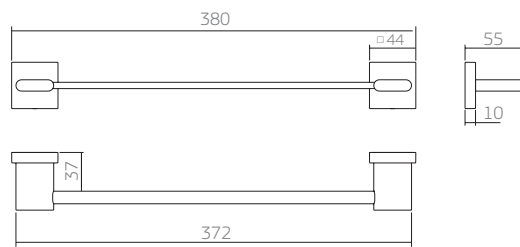

2040.C33.050
porta-toalha barra

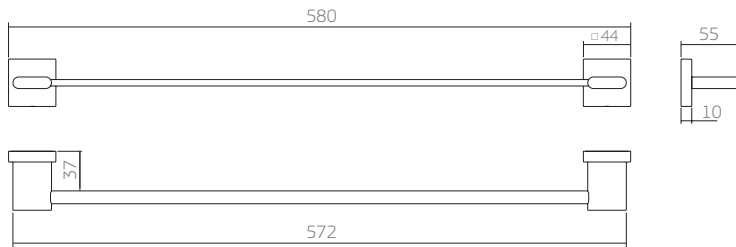

2030.C33
prateleira

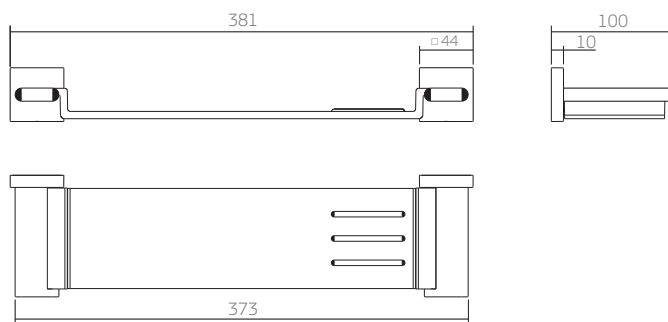

Disponível na versão cromado.

dimensões em milímetros

1877.C33
misturador
lavatório mesa

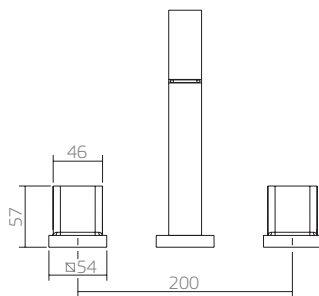
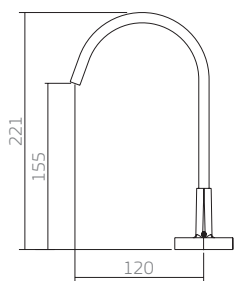

Este metal não deve ser instalado com as cubas L.90, L.903, L.71C e L.71.

1878.C33
misturador
lavatório parede

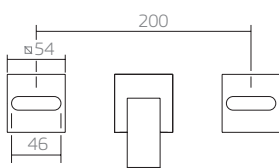
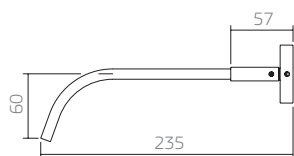

1191.C33
torneira
lavatório mesa

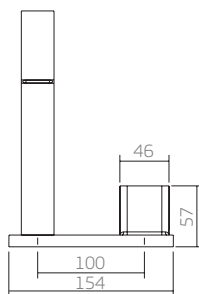
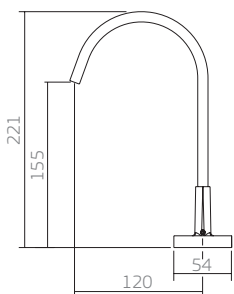

Este metal não deve ser instalado com as cubas L.105, L.102, L.102C, L.90, L.903, L.71C, e L.71.

1198.C33
torneira
lavatório mesa

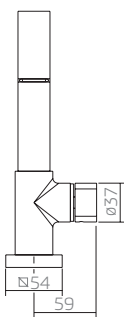
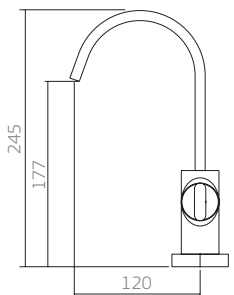

Utilizar a furação no tampo de 35mm para misturadores e torneiras de mesa.

dimensões em milímetros

1178.C33
torneira lavatório parede

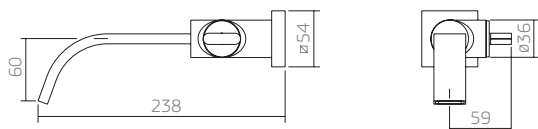

1179.C33
torneira lavatório parede

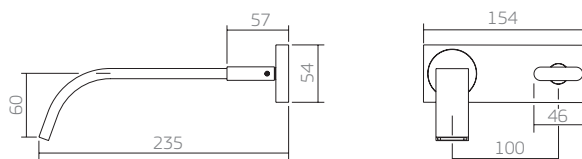

1984.C33.ACT.CR
ducha higiênica com
registro e derivação

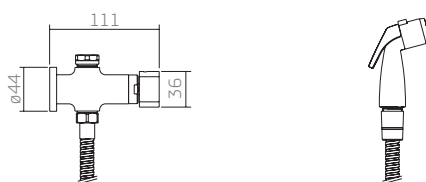

Comprimento do flexível 1,20m.

- 1895.C33 - misturador para bidê
- 1416.C33 - registro de pressão
- 1509.C33 - registro de gaveta
- 4900.C33 - acabamento para registro
- 4916.C33 - acabamento para registro de pressão com mecanismo MVR (1/2 volta)

dimensões em milímetros

1197.C.LNQ
torneira lavatório mesa

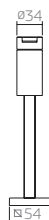
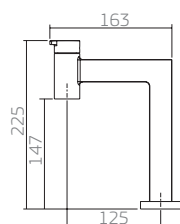

1198.C.LNQ
torneira lavatório mesa

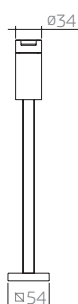
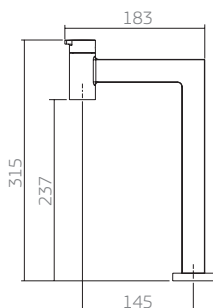

1178.C.LNQ
torneira lavatório parede

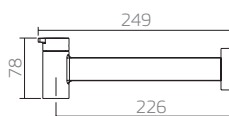

4900.C.PQ.LNQ / 4900.C.GD.LNQ - acabamento para registro
4916.C.LNQ - acabamento para registro de pressão com mecanismo MVR (½ volta)

dimensões em milímetros

Utilizar a furação no tempo de 35mm para misturadores e torneiras de mesa.

1877.C46
misturador
lavatório mesa

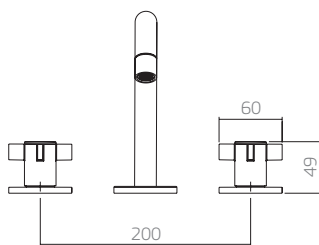
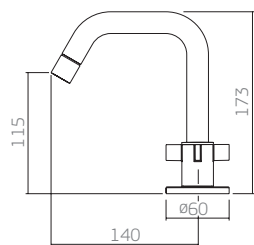

1198.C46
torneira
lavatório mesa

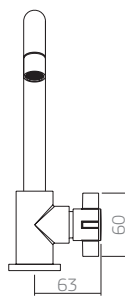
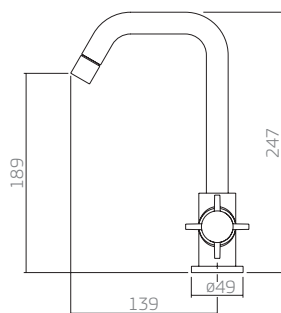

C46
cromado

Utilizar a furação do tampo de 35mm para misturadores e torneiras de mesa.

dimensões em milímetros

1878.C46
misturador
lavatório parede

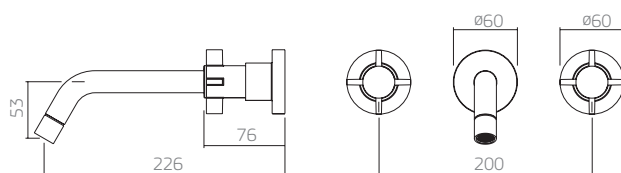

1178.C46
torneira
lavatório parede

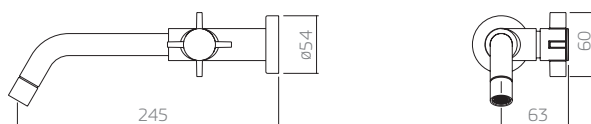

1984.C46.ACT.BR
ducha higiênica com registro,
derivação e gatilho branco

1984.C46.ACT.CR
ducha higiênica com registro,
derivação e gatilho cromado

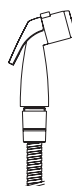
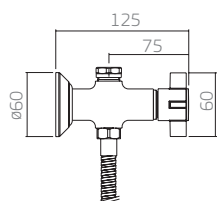

Comprimento do flexível 1,20m.

1895.C46 - misturador para bidê
4916.C46 - acabamento para registro de pressão com mecanismo MVR (½ volta)
4900.C46 - acabamento para registro

dimensões em milímetros

NOVO

1877.C.CLN
misturador lavatório mesa

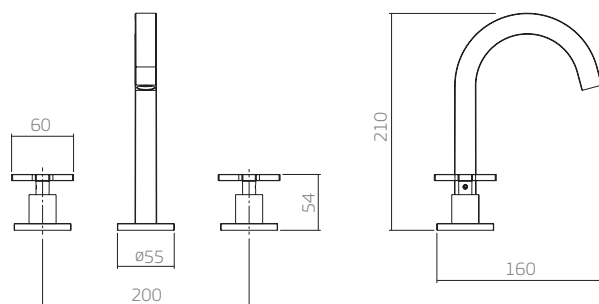

Este metal não deve ser instalado com as cubas L.90, L.903, L.71C e L.71.

1198.C.CLN
torneira lavatório mesa

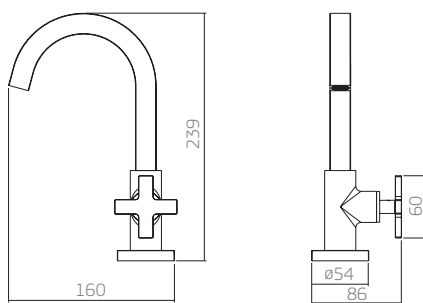

Utilizar furação no tampo de 35mm para misturadores e torneiras de mesa.

dimensões em milímetros



1878.C.CLN
misturador
lavatório parede

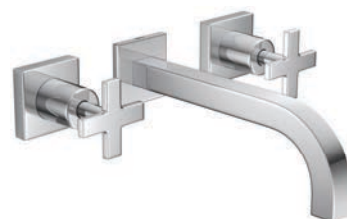
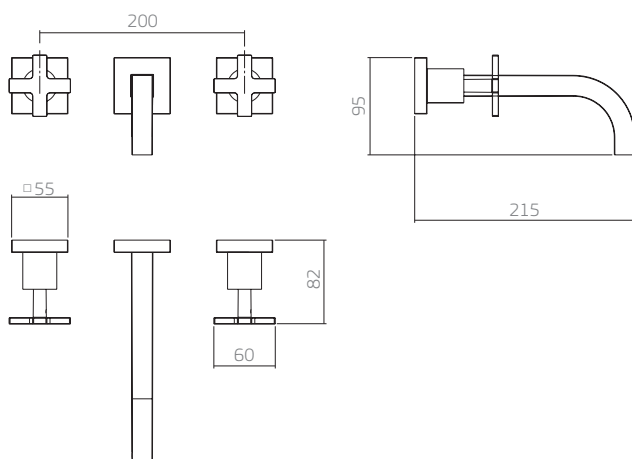

1178.C.CLN
torneira
lavatório parede

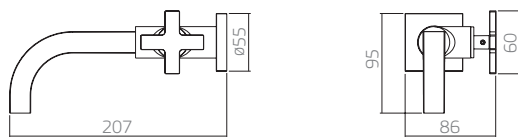

1984.C.CLN.ACT.CR
ducha higiênica com registro e
derivação e gatilho cromado

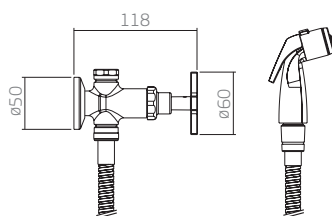

1984.C.CLN.ACT.BR
ducha higiênica com registro e
derivação e gatilho branco



Comprimento do flexível 1,20m.

- 1895.C.CLN - misturador para bidê
- 4900.C.CLN - acabamento para registro
- 4916.C.CLN - acabamento para registro de pressão com emcanismo MVR (1/2 volta)

dimensões em milímetros

1877.C.DSC
misturador lavatório mesa

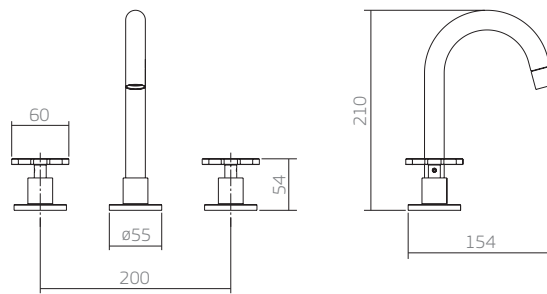

1198.C.DSC
torneira lavatório mesa

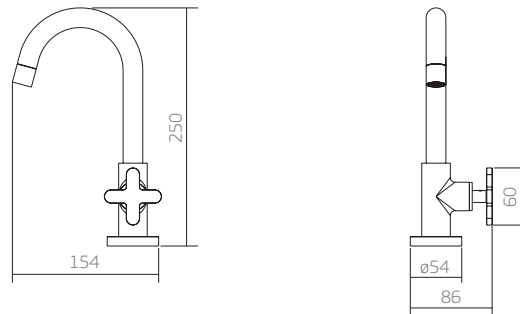

1878.C.DSC
misturador lavatório parede

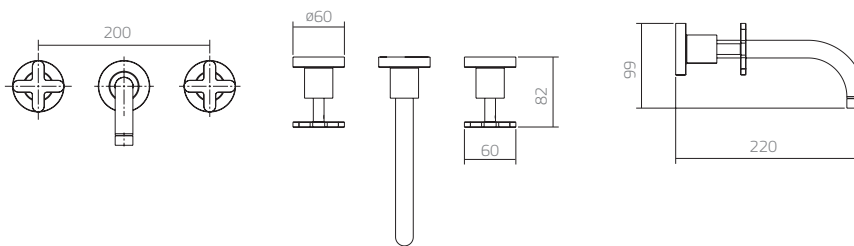

Utilizar a furação no tampo de 35mm para misturadores e torneiras de mesa.

dimensões em milímetros

1178.C.DSC
torneira lavatório parede

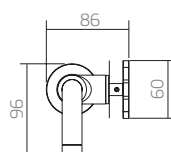
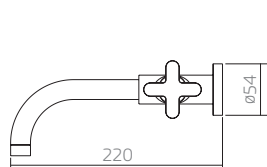

1984.C.DSC.ACT.CR
ducha higiênica com registro,
derivação e gatilho cromado

1984.C.DSC.ACT.CR
ducha higiênica com registro,
derivação e gatilho branco

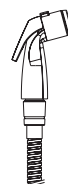
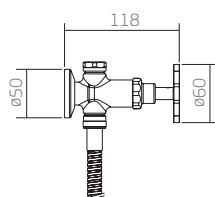

Comprimento do flexível 1,20m.

1895.C.DSC - misturador para bidê
4900.C.DSC - acabamento para registro
4916.C.DSC - acabamento para registro de pressão com mecanismo MVR (½ volta)

dimensões em milímetros

NOVO

2885.VA.KD
monocomando lavatório
mesa bica alta

2885.VB.KD
monocomando lavatório
mesa bica alta

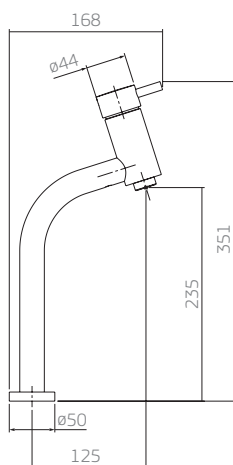

2875.VA.KD
monocomando lavatório
mesa bica baixa

2875.VB.KD
monocomando lavatório
mesa bica baixa

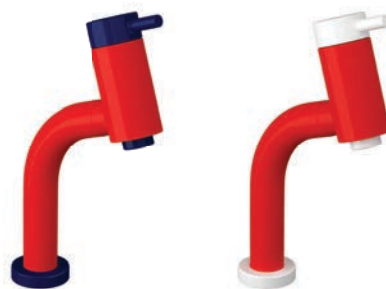
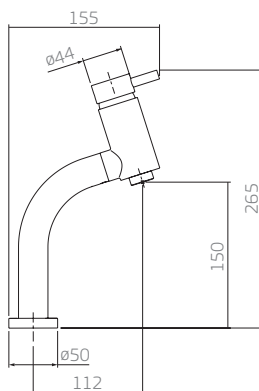

VA.KD
vermelho
e azul



VB.KD
vermelho
e branco

Utilizar a furação no tampo de 37mm para monocomandos.

dimensões em milímetros

NOVO

1877.VA..KD
misturador
lavatório mesa

1877.VB.KD
misturador
lavatório mesa

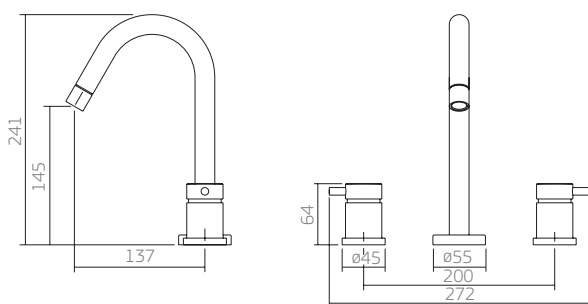

1197.VA.KD
torneira lavatório
mesa

1197.VB.KD
torneira lavatório
mesa

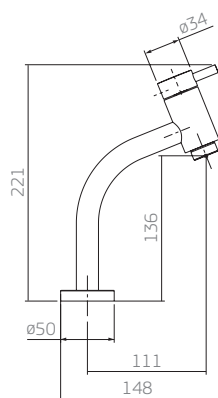

VA.KD
vermelho
e azul



VB.KD
vermelho
e branco

Utilizar a furação no tampo de 35mm para misturador e de 37mm para a torneira de mesa

dimensões em milímetros



2020.VA.KD
papeleira

2020.VB.KD
papeleira

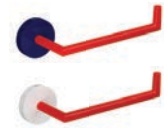
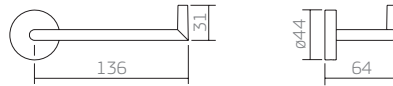

2010.VA.KD
saboneteira

2010.VB.KD
saboneteira

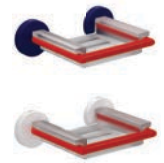
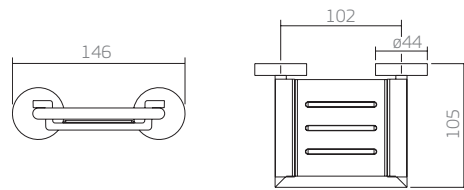

2060.VA.KD
cabide

2060.VB.KD
cabide

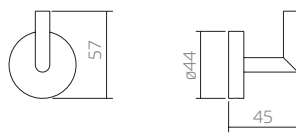

2040.VA.020.KD
porta-toalha

2040.VB.020.KD
porta-toalha

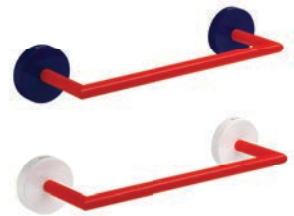
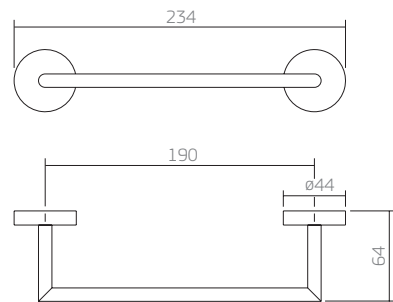

dimensões em milímetros

NOVO

2040.VA.030.KD
porta-toalha



2040.VB.030.KD
porta-toalha

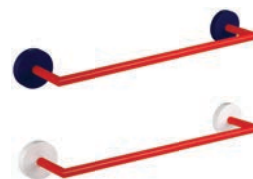
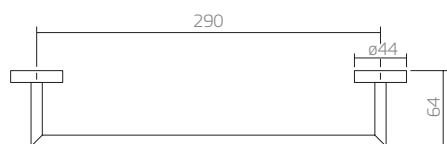

2040.VA.050.KD
porta-toalha



2040.VB.050.KD
porta-toalha

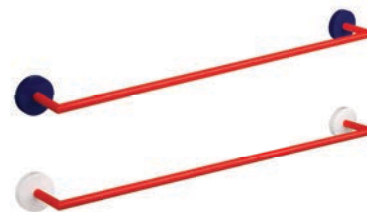

2030.VA.KD
prateleira



2030.VB.KD
prateleira

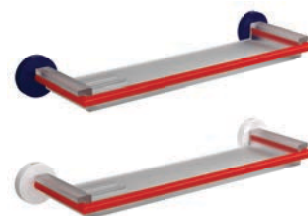
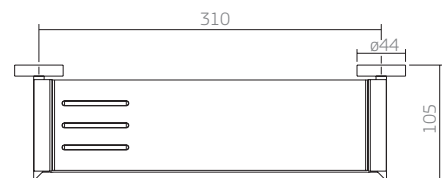

dimensões em milímetros

NOVO

1975.VA.KD
 chuveiro com desviador e
 ducha manual

1975.VB.KD
 chuveiro com desviador e
 ducha manual

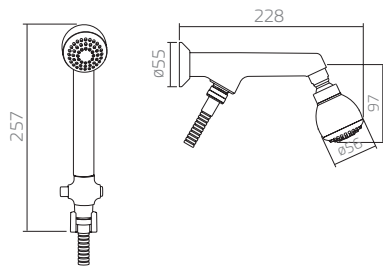
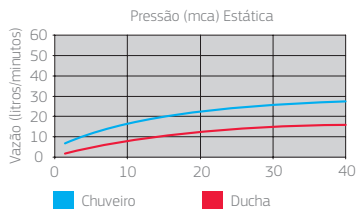

1973.VA.CT.KD
 chuveiro com tubo

1973.VB.CT.KD
 chuveiro com tubo

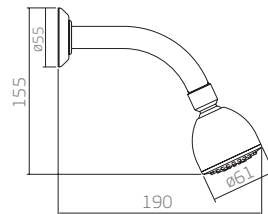
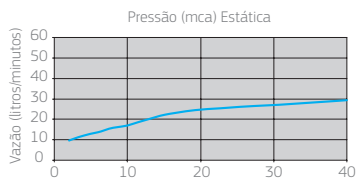

Recomendável com pressão mínima de 4 m.c.a. para aquecedor de passagem e de 2 m.c.a. para aquecedor de acumulação.

dimensões em milímetros



HYDRA DUO KIDS

A funcionalidade da Hydra Duo em uma versão divertida e que ensina as crianças a economizar água desde cedo.

Descarga com duplo acionamento.

São dois botões que regulam a quantidade de água a ser usada.

1 - Descarga com volume reduzido: limpeza rápida (aprox. 3 litros)

2 - Descarga completa: limpeza total (aprox. 6 litros)

Vermelho e azul

2545.VA.114.KD

válvula de descarga Hydra Duo Kids

2545.VA.112.KD

válvula de descarga Hydra Duo Kids

4900.VA.DUO.KD

acabamento Hydra Duo Kids



Vermelho e branco

2545.VB.114.KD

válvula de descarga Hydra Duo Kids

2545.VB.112.KD

válvula de descarga Hydra Duo Kids

4900.VB.DUO.KD

acabamento Hydra Duo Kids



- Descarga com duplo acionamento.
- Meia descarga: Aprox. 3 litros e descarga completa: Aprox. 6 litros.
- Disponível em duas bitolas
1 1/2" baixa pressão (2 a 10 m.c.a)
1 1/4" alta pressão (10 a 40 m.c.a)
- Possui regulagem de vazão
- Acionamento suave através do mecanismo Soft-touch.
- Pintura em epóxi de alta resistência.
- Acabamento metálico.
- 10 anos de garantia.

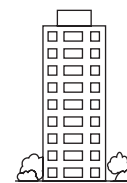

ALTA PRESSÃO
DN 32 (1 1/4")
100 a 400 Kpa
1,0 a 4,0 Kgf/cm²



BAIXA PRESSÃO
DN 40 (1 1/2")
20 a 100 Kpa
0,2 a 1,0 Kgf/cm²

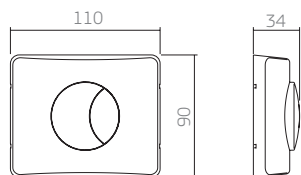

dimensões em milímetros



NOVO

1172.VA.KD
torneira lavatório mesa
fechamento automático

1172.VB.KD
torneira lavatório mesa
fechamento automático

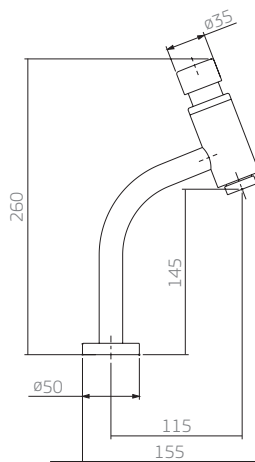

DECAMATIC KIDS

1968.E.KID.BR / 1968.C.KID
tubo de ligação para bacia infantil

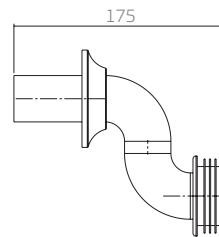
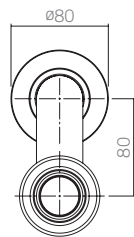

TUBO LIGAÇÃO KIDS

dimensões em milímetros

1877.C24
misturador
lavatório mesa

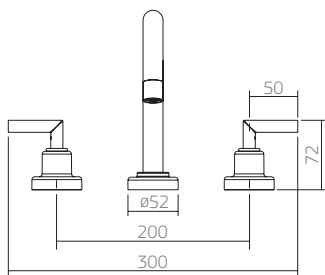
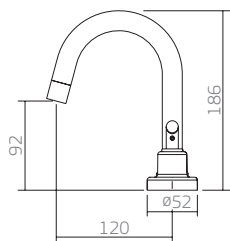

1198.C24
torneira
lavatório mesa

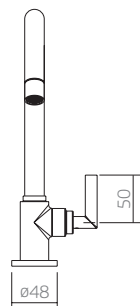
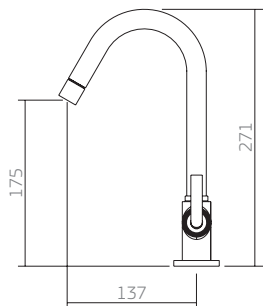

C.24
cromado

Utilizar a furação no tampo de 35mm para misturadores e torneiras de mesa.

dimensões em milímetros

1878.C24
misturador
lavatório parede

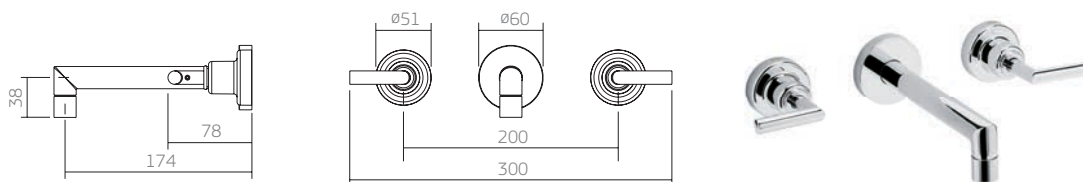

1178.C24
torneira
lavatório parede

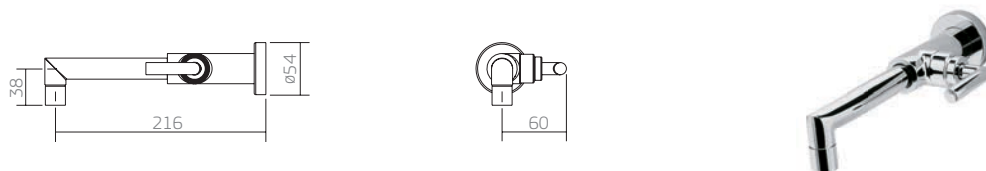

1984.C24.ACT.BR
ducha higiênica com
registro, derivação e
gatilho branco

1984.C24.ACT.CR
ducha higiênica com
registro, derivação e
gatilho cromado

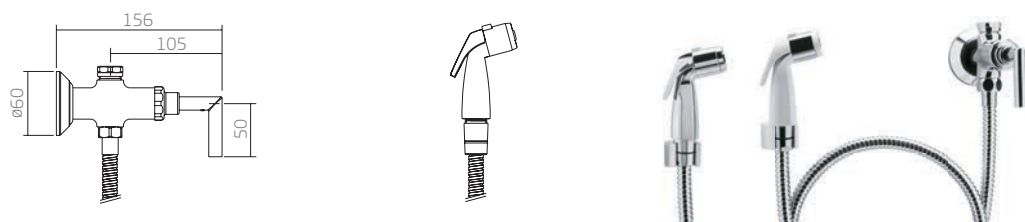

Comprimento do flexível 1,20m.

1895.C24 - misturador bidê
4900.C24 - Acabamento para registro
4916.C24 - Acabamento para registro de pressão com mecanismo MVR (1/2 volta)

dimensões em milímetros

ACESSÓRIOS IZY

2020.C37
papeleira

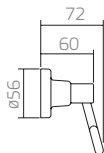
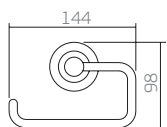

2011.C37
saboneteira parede

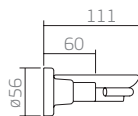
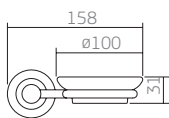

2060.C37
cabide

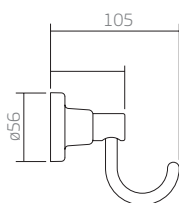
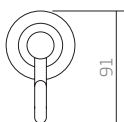

2050.C37
porta-toalha argola

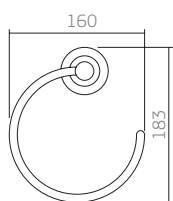

2040.C37
porta-toalha barra

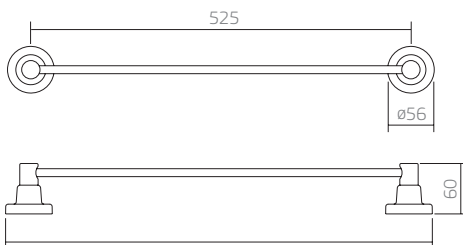

2030.C37
prateleira

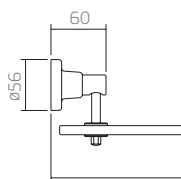
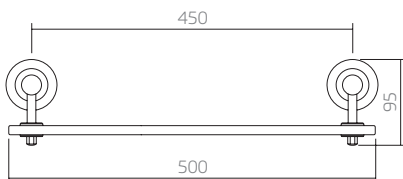

Espessura do vidro 10mm.

Disponível na versão cromado.

dimensões em milímetros

1875.C37
misturador
lavatório mesa

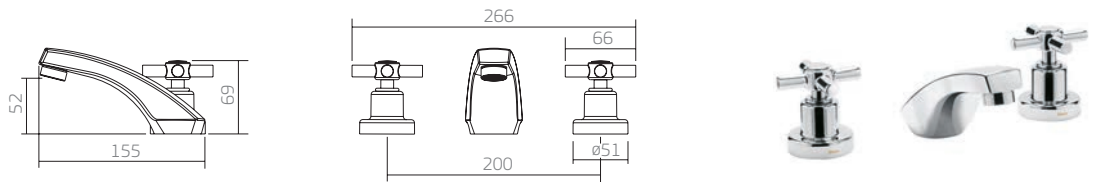

1877.C37
misturador
lavatório mesa

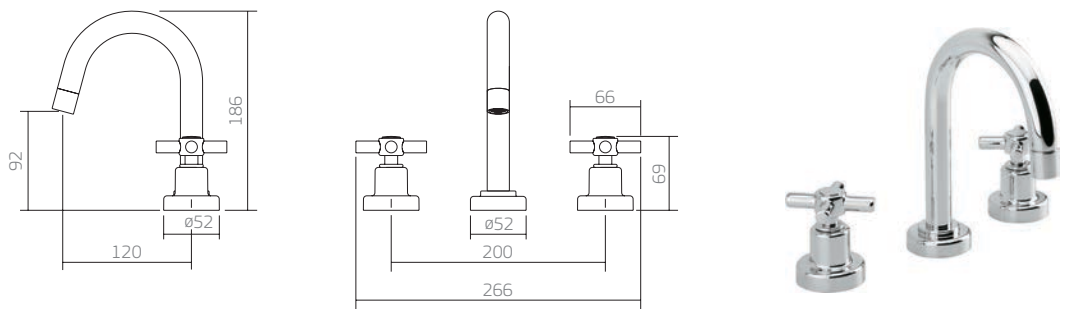

Utilizar a furação no tampo de 35mm para misturadores e torneiras de mesa.

dimensões em milímetros

1195.C37
torneira
lavatório mesa

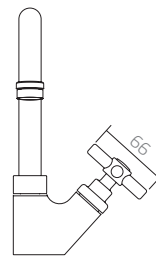
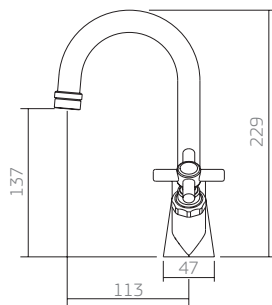

1198.C37
torneira lavatório mesa

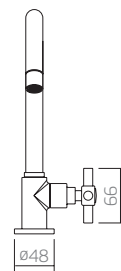
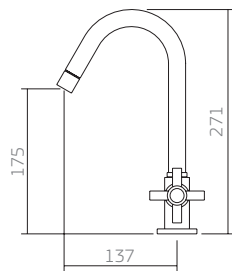

Utilizar a furação no tampo de 35mm para misturadores e torneiras de mesa.

dimensões em milímetros

1197.C37
torneira
lavatório mesa

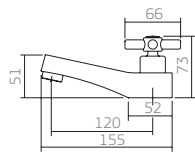

1878.C37
misturador lavatório parede

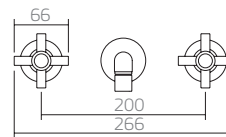
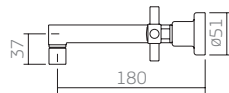

1178.C37
torneira
lavatório parede

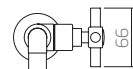
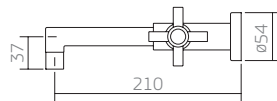

Utilizar a furação no tampo de 35mm para misturadores e torneiras de mesa.

dimensões em milímetros

1193.C37
torneira
lavatório mesa

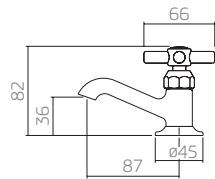

1894.C37
misturador com
ducha higiênica

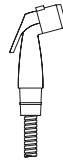
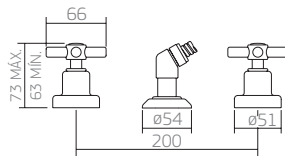

Comprimento do flexível 1,20m.

1984.C37.ACT.BR
ducha higiênica com
registro, derivação e
gatilho branco

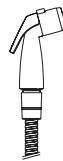
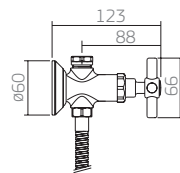

1984.C37.ACT.CR
ducha higiênica com
registro, derivação e
gatilho cromado

Comprimento do flexível 1,20m.

1895.C37 - misturador para bidê
4900.C37 - acabamento para registro

dimensões em milímetros

2020.C.CLN
papeleira

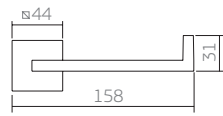

2010.C.CLN
saboneteira parede

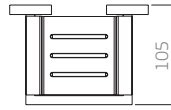
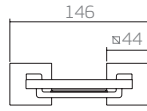

2060.C.CLN
cabide



2040.C.020.CLN
porta-toalha



2040.C.030.CLN
porta-toalha



2040.C.050.CLN
porta-toalha



2030.C.CLN
prateleira

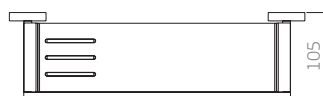

Disponível na versão cromado.

dimensões em milímetros

ACESSÓRIOS DISCO

2020.C.DSC
papeleira

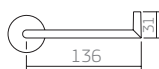

2010.C.DSC
saboneteira parede

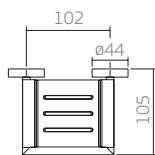
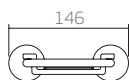

2060.C.DSC
cabide



2040.C.020.DSC
porta-toalha barra

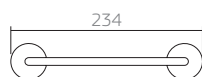

2040.C.030.DSC
porta-toalha barra

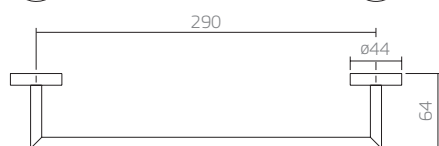
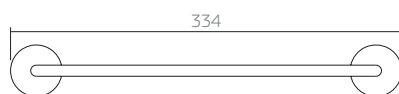

2040.C.050.DSC
porta-toalha barra



2030.C.DSC
prateleira

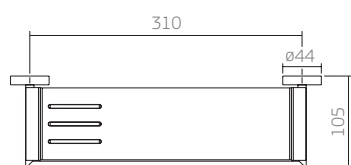
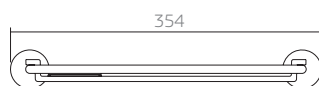

Disponível na versão cromado.

dimensões em milímetros

1877.C.LNK
misturador lavatório mesa

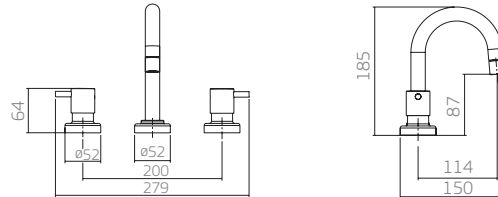

1197.C.LNK
torneira lavatório mesa

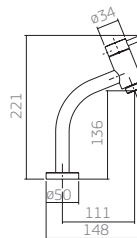

1198.C.LNK
torneira lavatório mesa

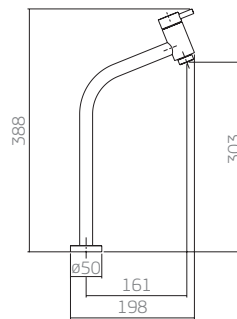

1199.C.LNK
torneira lavatório mesa

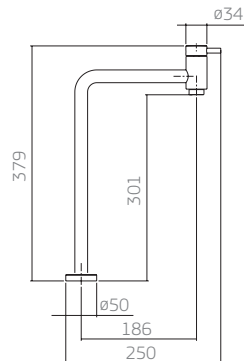

Utilizar somente a furação no tampo de 35mm para misturadores e 37mm para torneira de mesa.

dimensões em milímetros

1172.C.LNK
torneira de mesa com
fechamento automático

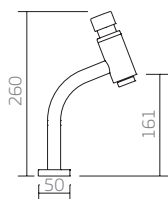

1174.C.LNK
torneira lavatório
parede curta

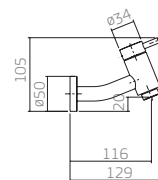

Desenvolvida especialmente para uso com cubas pequenas.

1178.C.LNK
torneira
lavatório parede

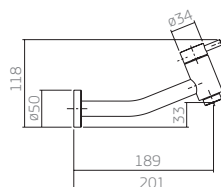

1153.C.LNK
torneira para jardim,
tanque e mangueira

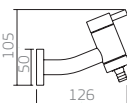

1984.C.ACT.LNK.BR
ducha higiênica com
registro e gatilho branco

1984.C.ACT.LNK.CR
ducha higiênica com
registro e gatilho cromado

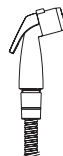
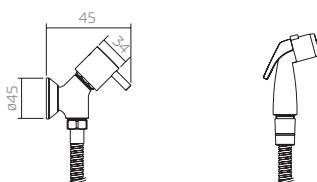

Comprimento do flexível 1,20m.

4900.C.PQ.LNK / 4900.C.GD.LNK - acabamento para registro.

dimensões em milímetros

Utilizar somente a furação no tampo de 35mm para misturadores e 37mm para torneira de mesa.

2021.C
papeleira com protetor

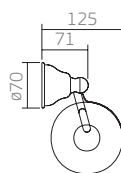
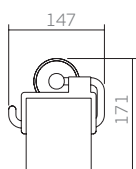

2010.C
saboneteira parede

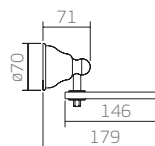
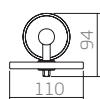

2011.C
saboneteira parede

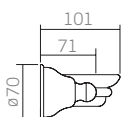
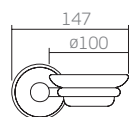

2060.C
cabide

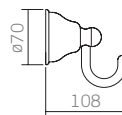

Disponível nas versões cromado e cromado com dourado.

dimensões em milímetros

ACESSÓRIOS BELLE ÉPOQUE

2050.C
porta-toalha

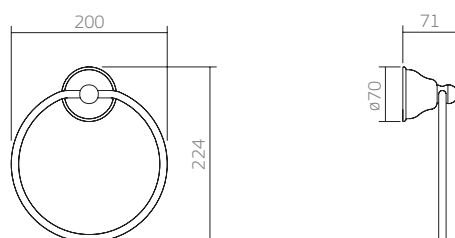

2040.C
porta-toalha barra

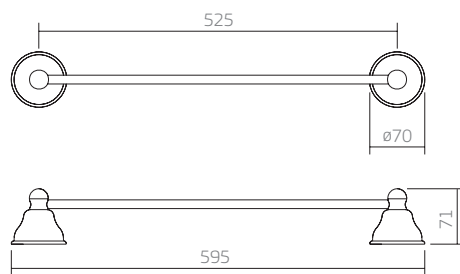

2041.C
porta-toalha articulado

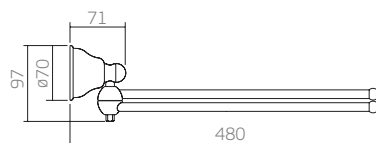

2030.C
prateleira

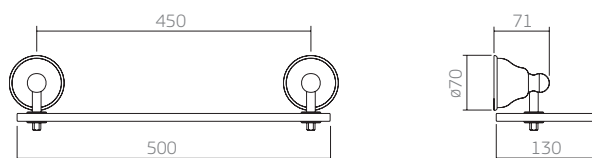

Disponível nas versões cromado e cromado com dourado.

dimensões em milímetros

1875.C52
misturador lavatório mesa

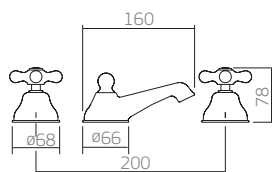

1876.C52
misturador lavatório mesa

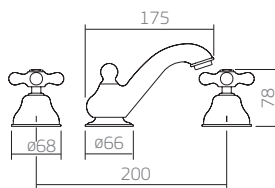

1877.C52
misturador lavatório mesa

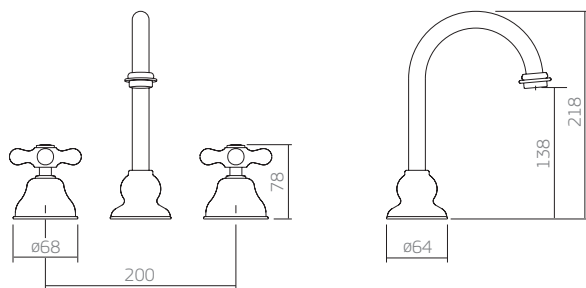

Utilizar a furação do tampo de 35mm para misturadores e torneiras de mesa.

dimensões em milímetros

BELLE ÉPOQUE TRADICIONAL

1198.C52
torneira lavatório mesa

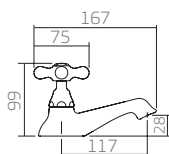

1199.C52
torneira lavatório mesa

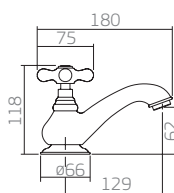

1984.C52.ACT
ducha higiênica com
registro com derivação

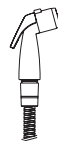
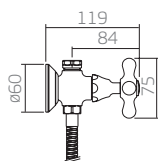

Comprimento de flexível 1,20m.

1895.C52 - misturador para bidê
4900.C52 - acabamento para registro

dimensões em milímetros

1875.C50
misturador lavatório mesa

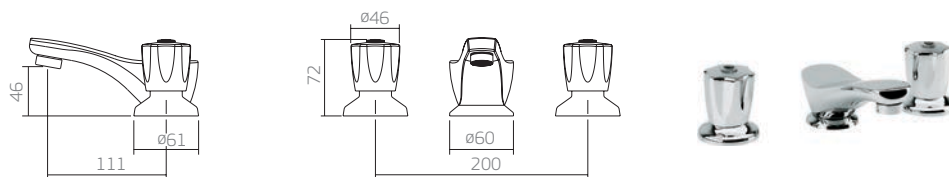

1192.C50
torneira lavatório mesa

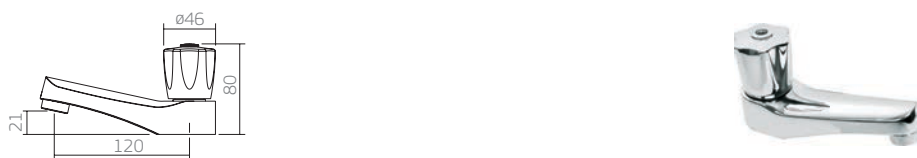

1195.C50
torneira lavatório mesa

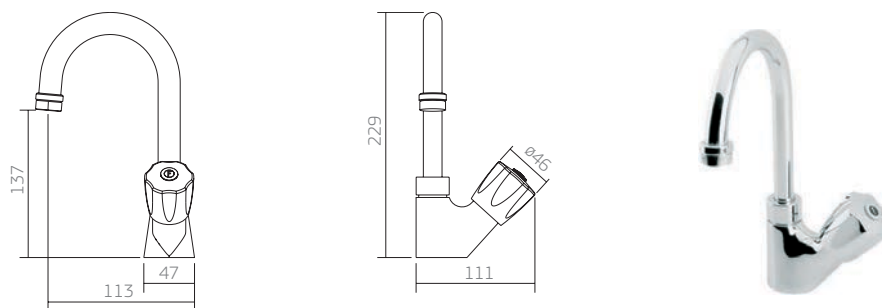

Utilizar o furação no tampo de 35mm para misturadores e torneiras de mesa.

dimensões em milímetros

1196.C50
torneira lavatório mesa

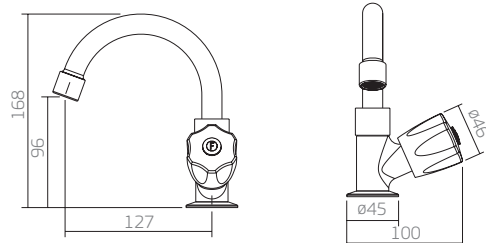

1199.C50
torneira lavatório mesa

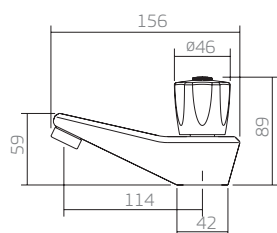

1984.C50.ACT
ducha higiênica com
registro e derivação

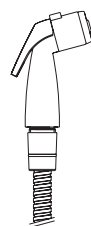
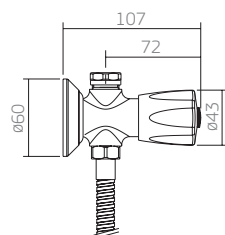

Comprimento do flexível 1,20m.

1895.C50 - misturador para bidê
4900.C50 - acabamento para registro

dimensões em milímetros

2020.C40.CR
papeleira

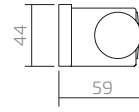

2010.C40.CR
saboneteira parede

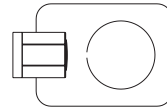
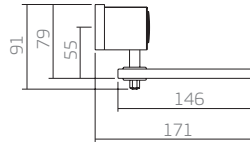
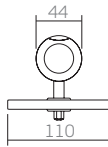

Espessura do vidro 10 mm.

2060.C40.CR
cabide

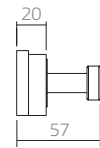

2050.C40.CR
porta-toalha argola

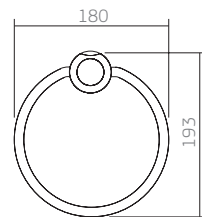

2040.C40.CR
porta-toalha barra

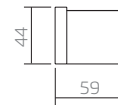
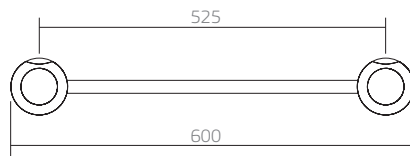

2030.C40.CR
prateleira

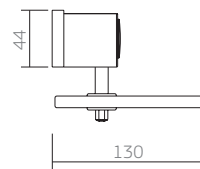
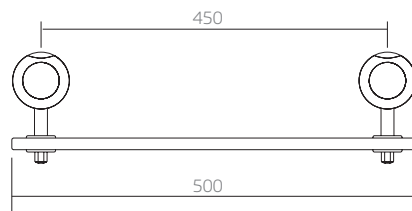

Espessura do vidro 10 mm.

Disponível nas versões cromado e branco com cromado.

dimensões em milímetros

1875.C40.CR
misturador
lavatório mesa

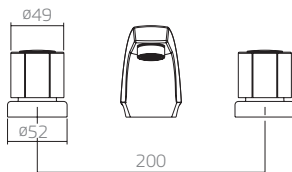
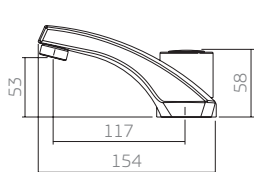

1877.C40.CR
misturador
lavatório mesa

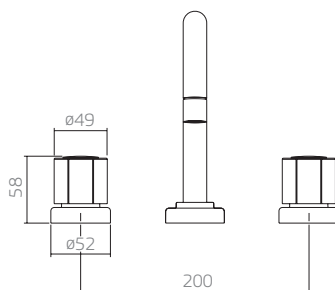
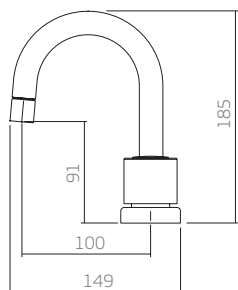

Somente na versão cromada.

1190.C40.CR
torneira
lavatório mesa

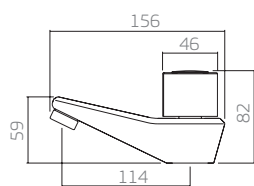

1192.C40.CR
torneira
lavatório mesa

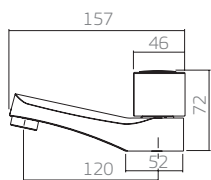

Somente na versão cromada.



Utilizar a furação no tampo de 35mm para misturadores e torneiras de mesa

dimensões em milímetros

1195.C40.CR
torneira lavatório mesa

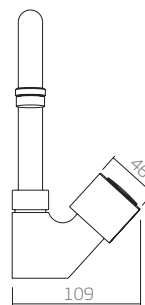
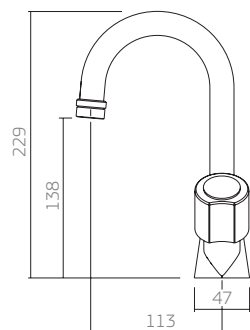

1196.C40.CR
torneira lavatório mesa

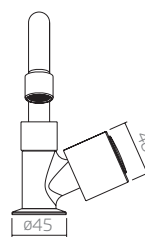
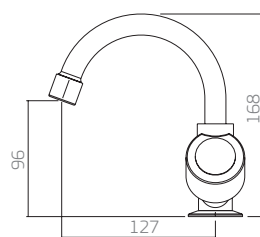

Somente na versão cromada.

1894.C40.CR
ducha higiênica com
registro

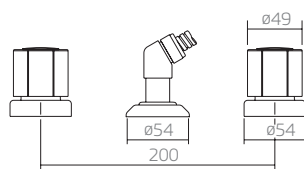

Acabamento somente na versão cromada.
Comprimento do flexível 1,20m.

1984.C40.ACT.CR
ducha higiênica com
registro com derivação

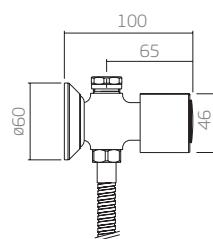

Comprimento do flexível 1,20m.

1895.C40.CR - misturador para bidê
1416.C40 - registro de pressão
1509.C40 - registro de gaveta
4900.C40.CR - acabamento para registro

dimensões em milímetros

1875.C35
misturador
lavatório mesa

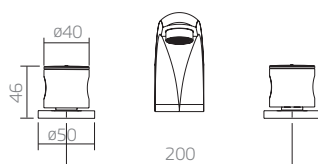
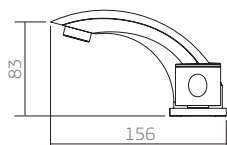

1877.C35
misturador
lavatório mesa

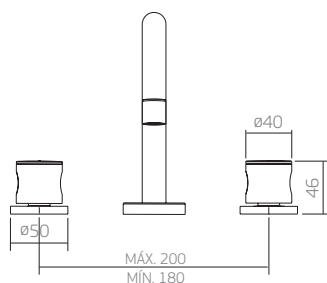
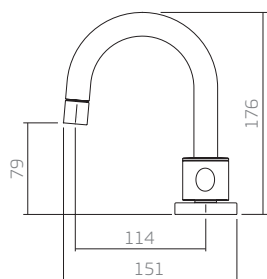

1195.C35
torneira
lavatório mesa

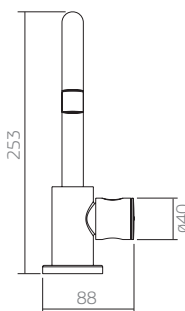
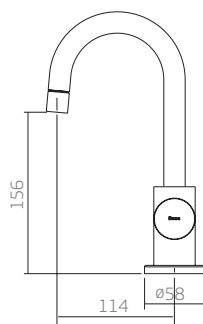

1196.C35
torneira
lavatório mesa

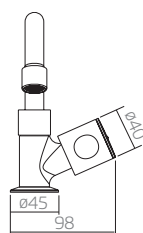
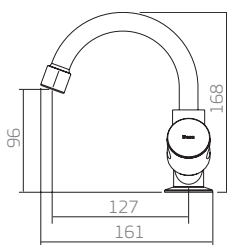

C35
cromado

Utilizar a furação no tampo de 35mm para misturadores e torneiras de mesa.
Sugerimos utilizar acessórios Evidence ou Flex.

dimensões em milímetros

1198.C35
torneira lavatório mesa

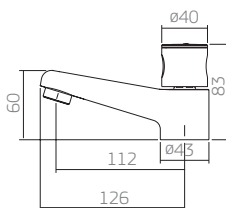

1178.C35
torneira lavatório parede

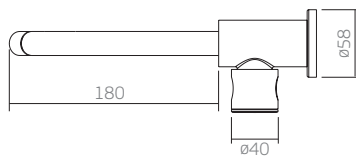
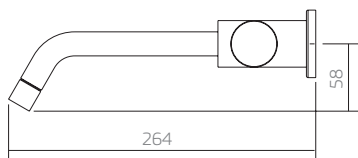

1984.C35.ACT
ducha higiênica com
registro sem derivação

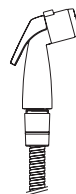
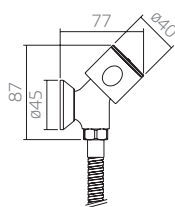

Comprimento do flexível 1,20m.

- 1895.C35 - misturador para bidê
- 1416.C35 - registro de pressão
- 1509.C35 - registro de gaveta
- 4900.C35 - acabamento para registro

dimensões em milímetros

1877.C34
misturador lavatório mesa

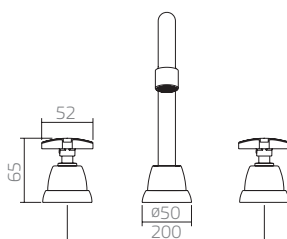
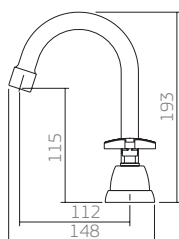

1196.C34
torneira lavatório mesa

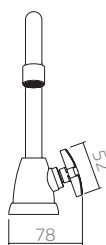
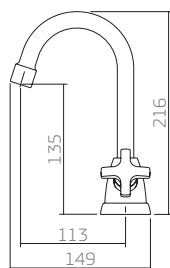

1197.C34
torneira lavatório mesa

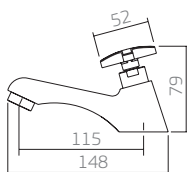

1152.C34
torneira para jardim e tanque

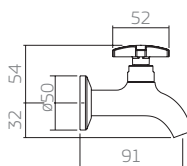

1153.C34
torneira para jardim,
tanque e mangueira

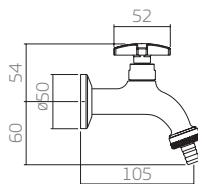

Utilizar a furação no tampo de 35mm para misturadores e torneiras de mesa.

dimensões em milímetros

1154.C34
torneira para jardim e
tanque com arejador

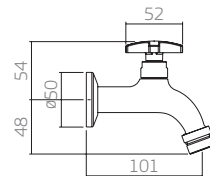

1158.C34
torneira cozinha parede

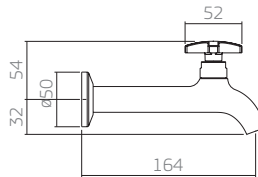

1159.C34
torneira cozinha
parede com arejador

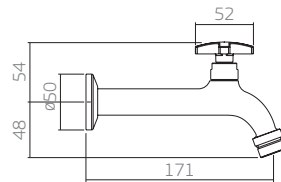

1984.C34.ACT
ducha higiênica
com registro

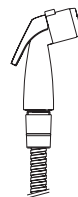
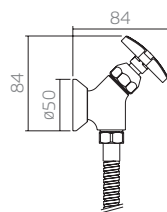

Comprimento do flexível 1,20m.

1895.C34 - misturador para bidê
4900.C34 - acabamento para registro

dimensões em milímetros

1875.C43
misturador lavatório mesa

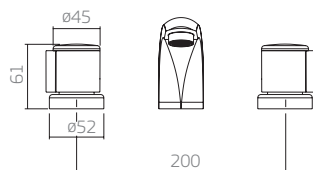
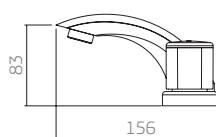

1877.C43
misturador lavatório mesa

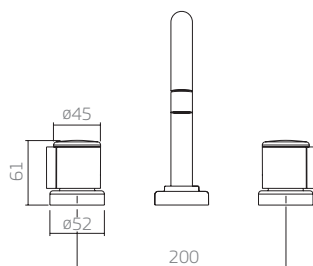
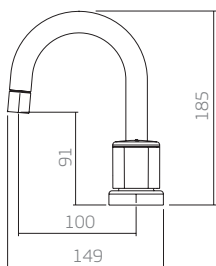

1195.C43
torneira lavatório mesa

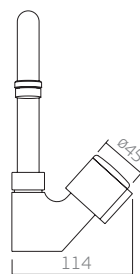
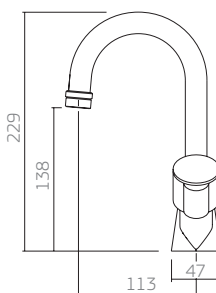

Utilizar a furação no tampo de 35mm para misturadores e torneiras de mesa.
Sugerimos utilizar acessórios Evidence ou Flex

dimensões em milímetros

1196.C43
torneira lavatório mesa

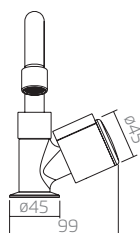
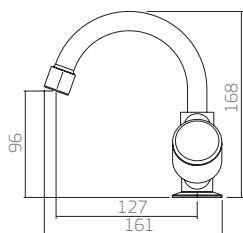

1198.C43
torneira lavatório mesa

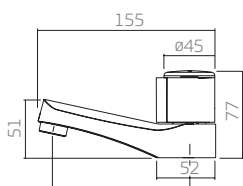

1984.C43.ACT
ducha higiênica com registro

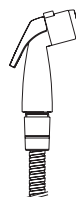
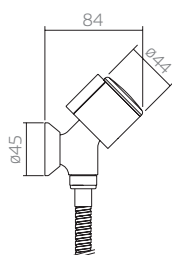

Comprimento do flexível 1,20m.

- 1895.C43 - misturador para bidê
- 1416.C43 - registro de pressão
- 1509.C43 - registro de gaveta
- 4900.C43 - acabamento para registro

dimensões em milímetros

2020.C.EVD
papeleira

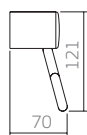
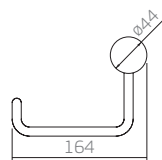

2011.C.EVD
saboneteira parede

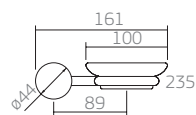

2060.C.EVD
cabide

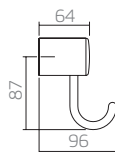
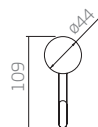

2050.C.EVD
porta-toalha argola

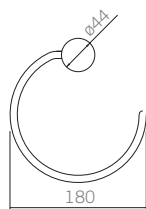

Disponível na versão cromado.

dimensões em milímetros

2040.C.EVD
porta-toalha barra

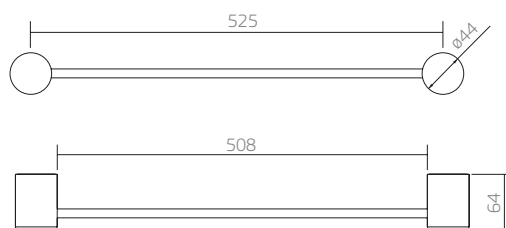

2030.C.EVD
prateleira

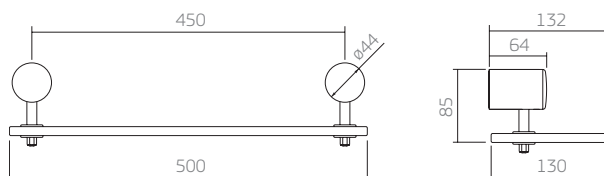

1984.C.ACT
ducha higiênica com registro

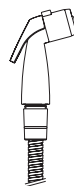
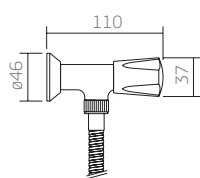

Comprimento do flexível 1,20m.

2000.C.EVD
kit acessórios 5 peças:
saboneteira, papeleira, porta toalha barra, porta toalha argola e cabide



Disponível na versão cromado.

dimensões em milímetros

2020.C.FLX
papeleira

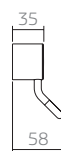
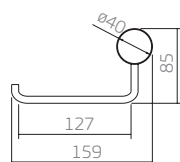

2010.C.FLX
saboneteira parede

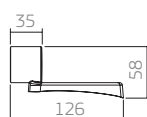
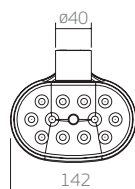

2060.C.FLX
cabide

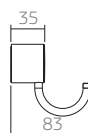
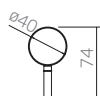

2050.C.FLX
porta-toalha argola

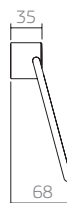
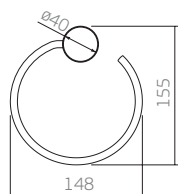

Disponível na versão cromado.

dimensões em milímetros

2040.C.FLX
porta-toalha barra

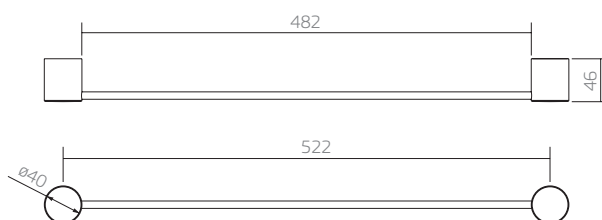

2030.C.FLX
prateleira

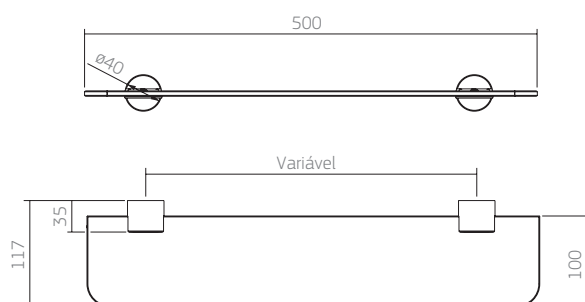

Espessura do vidro 6mm.

2000.C.FLX
kit acessórios 3 peças:
saboneteira, porta-toalha argola e papeleira



2001.C.FLX
kit acessórios 5 peças:

saboneteira, papeleira, cabide, porta-toalha barra e porta-toalha argola



Disponível na versão cromado.

dimensões em milímetros

STANDARD

1152.C39
torneira para jardim e tanque

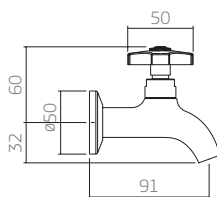

STANDARD

1153.C39
torneira para jardim, tanque e mangueira

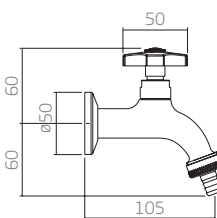

STANDARD

1154.C39
torneira para jardim e tanque com arejador

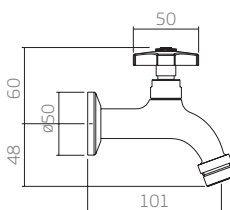

STANDARD

1155.C39
torneira para tanque com derivação para máquina de lavar

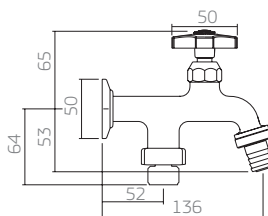

Disponível na versão cromado.

4900.C39 - acamento para registro

dimensões em milímetros

USO RESTRITO

1156.C
torneira USO RESTRITO para
jardim, tanque e mangueira

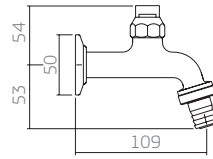
**IZY**

1152.C37
torneira para jardim e tanque

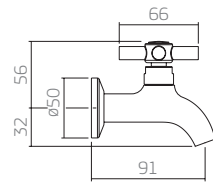
**IZY**

1153.C37
torneira para jardim,
tanque e mangueira

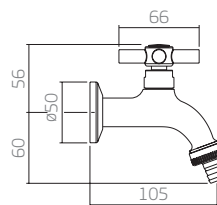
**IZY**

1154.C37
torneira para jardim e
tanque com arejador

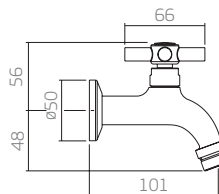
**IZY**

1155.C37
torneira para tanque com derivação
para máquina de lavar

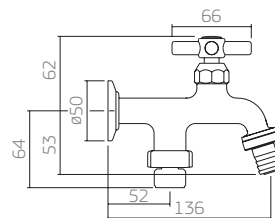

Disponível na versão cromado.

dimensões em milímetros

BELLE ÉPOQUE LIGHT

1152.C51
torneira para jardim e tanque

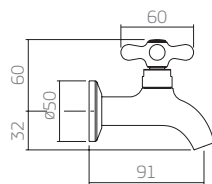

BELLE ÉPOQUE LIGHT

1153.C51
torneira para jardim,
tanque e mangueira

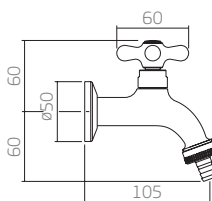

BELLE ÉPOQUE LIGHT

1154.C51
torneira para jardim e
tanque com arejador

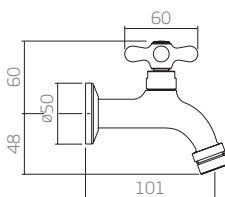

BELLE ÉPOQUE LIGHT

1155.C51
torneira para tanque com derivação
para máquina de lavar

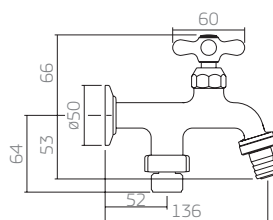

Disponível na versão cromado.

dimensões em milímetros

LINK

1153.C.LNK*
torneira para jardim,
tanque e mangueira

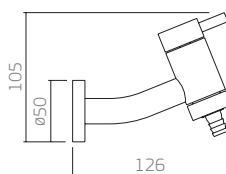

USO GERAL

1130.BC
torneira para jardim e tanque
com rosca para mangueira

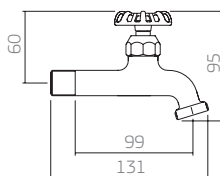

USO GERAL

1130.B
torneira para jardim e tanque
com rosca para mangueira

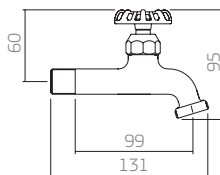

* Disponível na versão cromado.

dimensões em milímetros

STANDARD

1193.C39
torneira lavatório mesa

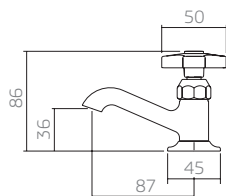

BELLE ÉPOQUE LIGHT

1193.C51
torneira lavatório mesa

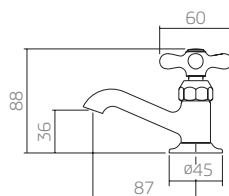

IZY

1193.C37
torneira lavatório mesa

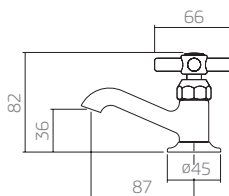

dimensões em milímetros



Deca

MONOCOMANDOS

DECA TOUCH	239
UNIC	240
AXIS	242
DECAMIX	244
FORUM	245
KIDS	246
VOGUE PLUS	247
LINK	248
SMART	249
DECA SENSE	251
GOURMET	251
UNIC GOURMET	252
SPIN GOURMET	252
UNIC	252
SPIN MOTION	253
TWIN	253
COPPA	253
SPIN	254
PREMIUM	254
VOGUE PLUS	255
LINK	255
SMART	255

- Acionamento com um suave toque.
- Indicação de temperatura através de LED luminoso (gradativo de azul a vermelho).
- Programação para até dois perfis de usuários.

2875.C.TCH
monocomando mesa

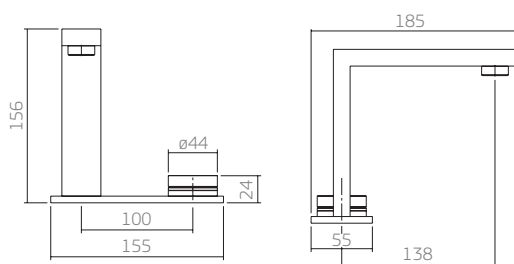

Este metal não deve ser instalado com as cubas L.102, L.102C, L.90, L.903, L.71 e L.105.

2993.C.TCH
monocomando para
chuveiro de alta pressão

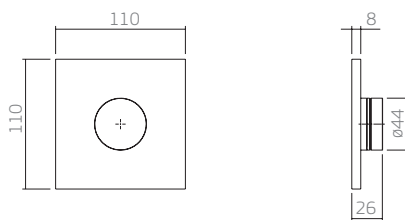

2993.C.TCH.CON
monocomando para
chuveiro, com controle
remoto alta pressão

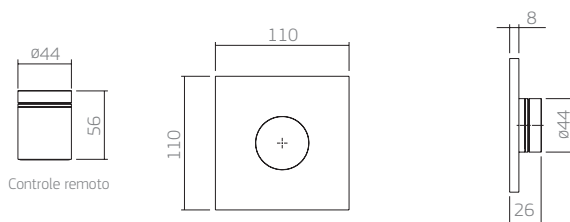

Controle remoto

Disponível na versão cromado.
Disponibilidade do produto para venda condicionada ao prazo de fabricação.
Recomendável com pressão mínima de 10 m.c.a.
Tensão de funcionamento: bivolt.
Este produto exige instalações elétricas próprias.

dimensões em milímetros

2885.C90
monocomando mesa

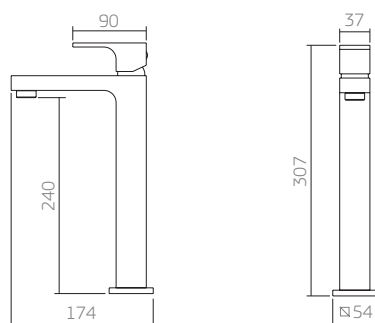

Recomendável com pressão mínima de 18 m.c.a para aquecedor de passagem e de 4 m.c.a para aquecedor de acumulação.

2875.C90
monocomando mesa

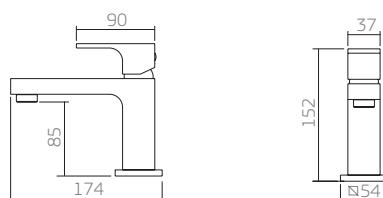

Recomendável com pressão mínima de 18 m.c.a para aquecedor de passagem e de 4 m.c.a para aquecedor de acumulação.

2885.C90.CAS
monocomando mesa

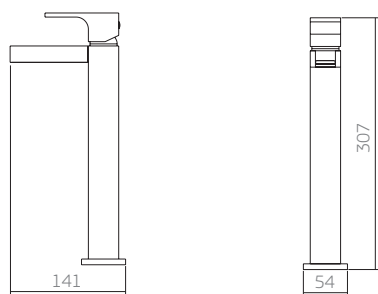

Recomendável com pressão mínima de 10 m.c.a para aquecedor de passagem e de 4 m.c.a para aquecedor de acumulação.
Disponível nas versões cromado e gold.



F90.PTO
preto fosco



C90
cromado



D90.GLD
gold

dimensões em milímetros

2875.C90.CAS
monocomando mesa

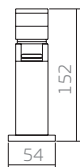
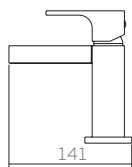

Recomendável com pressão mínima de 10 m.c.a para aquecedor de passagem e de 4 m.c.a para aquecedor de acumulação.
Disponível nas versões cromado e gold.

2993.C90.034
monocomando para chuveiro
baixa e alta pressão

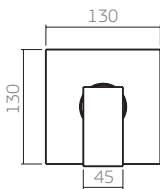

Disponível na versão cromado.

2994.C90
monocomando para
chuveiro com desviador
para banheira

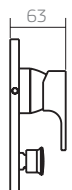
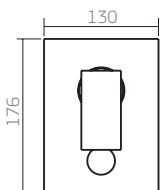

Disponível na versão cromado.

4993.C90.ACT - acabamento monocomando para ducha higiênica baixa e alta pressão
4993.C90.CHU - acabamento monocomando para chuveiro baixa e alta pressão

dimensões em milímetros

2878.C73
monocomando parede

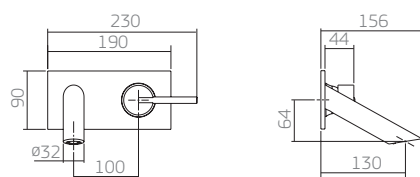

Não pode ser instalado no Suporte SL.01.
Recomendável com pressão mínima de 10 m.c.a para aquecedor de passagem e de 4 m.c.a para aquecedor de acumulação.

2885.C73
monocomando mesa

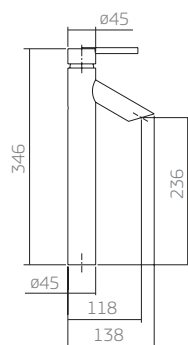

Recomendável com pressão mínima de 10 m.c.a para aquecedor de passagem e de 4 m.c.a para aquecedor de acumulação.



C73
cromado

dimensões em milímetros

2895.C73
monocomando para bidê

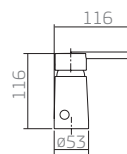

Recomendável com pressão mínima de 10 m.c.a para aquecedor de passagem e de 4 m.c.a para aquecedor de acumulação.

2875.C73
monocomando mesa

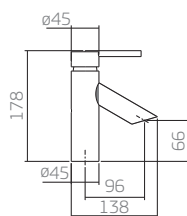

Recomendável com pressão mínima de 10 m.c.a para aquecedor de passagem e de 4 m.c.a para aquecedor de acumulação.

2993.C73.034
monocomando para chuveiro
baixa e alta pressão

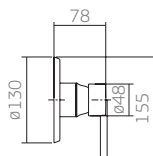

- 4900.C73 - acabamento para registro
- 4916.C73.PQ - acabamento para registro
- 4993.C73.ACT - acabamento monocomando para ducha baixa e alta pressão
- 4993.C73.CHU - acabamento monocomando para chuveiro baixa e alta pressão

dimensões em milímetros

2875.C79.CR
monocomando
lavatório mesa

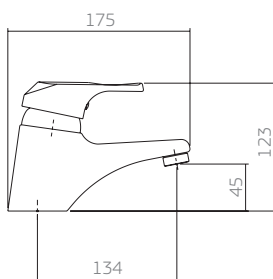

Recomendável com pressão mínima de 6 m.c.a para aquecedor de passagem e de 2 m.c.a para aquecedor de acumulação.

2993.C79.034.CR
monocomando para chuveiro
baixa e alta pressão

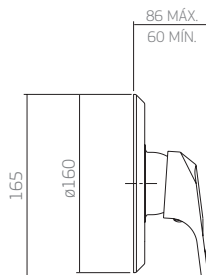

4493.C79.CHU - acabamento monocomando para chuveiro baixa e alta pressão
4993.C79.ACT - CR acabamento monocomando para ducha higiênica baixa e alta pressão

dimensões em milímetros

2875.C49
monocomando lavatório mesa

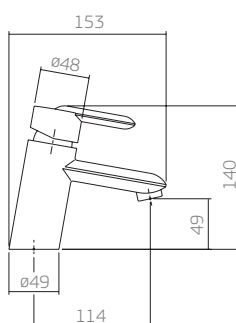

Diâmetro do furo de tampo para lavatório 37mm.
Recomendável com pressão mínima de 6 m.c.a para aquecedor de passagem e de 2 m.c.a para aquecedor de acumulação.

2895.C49
monocomando para bidê

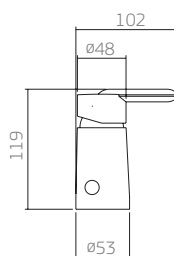

Recomendável com pressão mínima de 6 m.c.a para aquecedor de passagem e de 2 m.c.a para aquecedor de acumulação.

2993.C49.034
monocomando para chuveiro
baixa e alta pressão

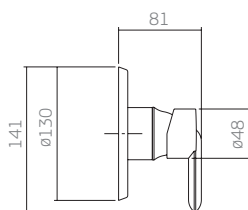

4900.C49 - acabamento para registro
4993.C49.CHU - acabamento monocomando para chuveiro baixa e alta pressão
4993.C49.ACT - acabamento monocomando para ducha higiênica baixa e alta pressão

dimensões em milímetros

NOVO

2885.VA.KD
monocomando lavatório
mesa bica alta

2885.VB.KD
monocomando lavatório
mesa bica alta

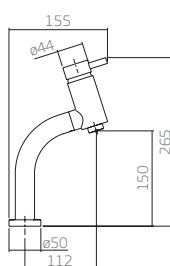

2875.VA.KD
monocomando lavatório
mesa bica baixa

2875.VB.KD
monocomando lavatório
mesa bica baixa

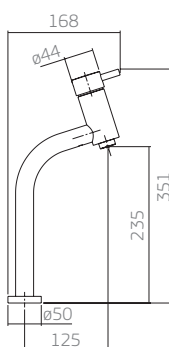

VA.KD
vermelho
e azul



VB.KD
vermelho
e branco

Diâmetro nos furos do tampo para lavatório de 37mm.

dimensões em milímetros

2875.C36
monocomando lavatório mesa

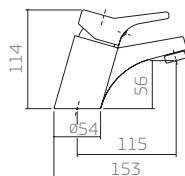

Recomendável com pressão mínima de 6 m.c.a para aquecedor de passagem e de 2 m.c.a para aquecedor de acumulação.

2895.C36
monocomando para bidê

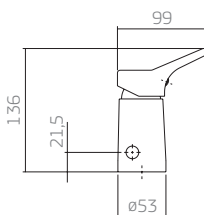

Recomendável com pressão mínima de 6 m.c.a para aquecedor de passagem e de 2 m.c.a para aquecedor de acumulação.

2993.C36.034
monocomando para chuveiro
baixa e alta pressão

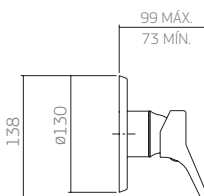

2994.C36
monocomando para chuveiro
com desviador

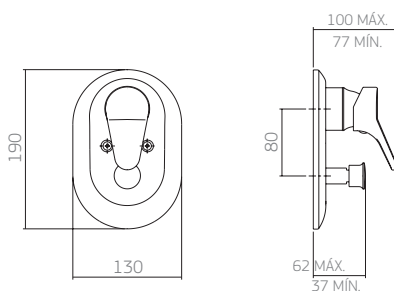

Recomendável com pressão mínima de 6 m.c.a para aquecedor de passagem e de 2 m.c.a para aquecedor de acumulação.



C36
cromado

Diâmetro do furo de tampo para lavatório 37mm.

dimensões em milímetros

- 4993.C36.CHU - acabamento monocomando para chuveiro baixa e alta pressão
- 4493.C36.ACT - acabamento monocomando para ducha higiênica baixa e alta pressão

2886.C.LNK
monocomando lavatório
mesa tubo 90°

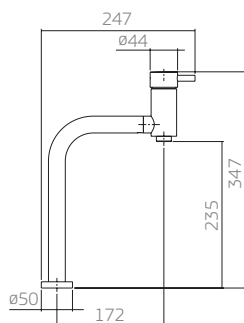

Recomendável com pressão mínima de 10 m.c.a para aquecedor de passagem e de 2 m.c.a para aquecedor de acumulação.

2885.C.LNK
monocomando lavatório
mesa bica alta

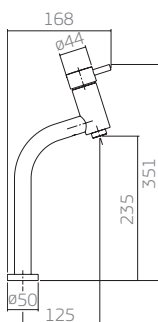

Recomendável com pressão mínima de 10 m.c.a para aquecedor de passagem e de 2 m.c.a para aquecedor de acumulação.

2875.C.LNK
monocomando lavatório
mesa bica baixa

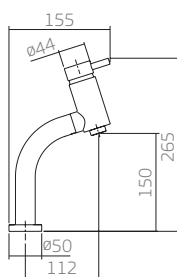

Recomendável com pressão mínima de 10 m.c.a para aquecedor de passagem e de 2 m.c.a para aquecedor de acumulação



C.LNK
cromado

4900.C.PQ.LNK / 4900.C.GD.LNK - acabamento para registro

Diâmetro dos furos de tampo para lavatório 37mm.

dimensões em milímetros

2875.C71
monocomando
lavatório mesa

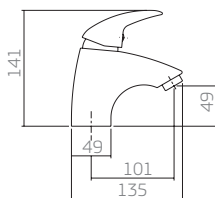

Recomendável com pressão mínima de 6 m.c.a para aquecedor de passagem e de 2 m.c.a para aquecedor de acumulação

2895.C71
monocomando para bidê

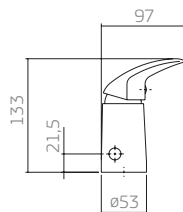

Recomendável com pressão mínima de 6 m.c.a para aquecedor de passagem e de 2 m.c.a para aquecedor de acumulação

1984.C71.ACT
ducha higiênica com registro e
derivação

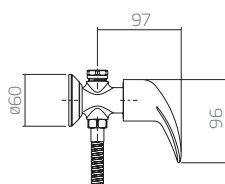

Recomendável com pressão mínima de 6 m.c.a para aquecedor de passagem e de 2 m.c.a para aquecedor de acumulação



C71
cromado

Diâmetro dos furos de tempo para lavatório 37mm.

dimensões em milímetros

2993.C71.034
monocomando para chuveiro
baixa e alta pressão

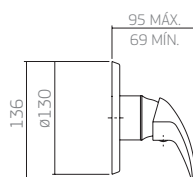

2994.C71
monocomando para chuveiro
com desviador baixa e alta
pressão

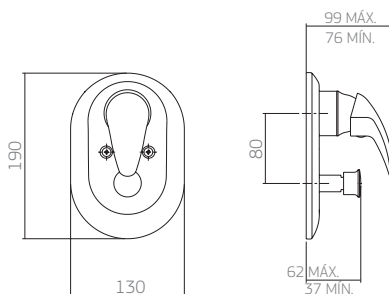

Recomendável com pressão mínima de 6 m.c.a para aquecedor de
passagem e de 2 m.c.a para aquecedor de acumulação

- 4900.C71 - acabamento para registro
- 4993.C71.CHU - acabamento monocomando para chuveiro baixa e alta pressão
- 4993.C71.ACT - acabamento monocomando para ducha higiênica baixa e alta pressão

dimensões em milímetros

2295.C.SNS
monocomando cozinha mesa
bica móvel

- flexível com alcance de 40 cm
- dois tipos de jatos

Acionamento ON/OFF por toque, no corpo da bica.
Recomendável com pressão mínima de 18 m.c.a para aquecedor de passagem e de acumulação.

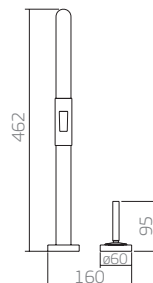
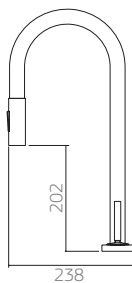

NOVO

DECA SENSE

2280.C
monocomando cozinha
mesa bica móvel gourmet

Medida aproximada em função da mola.
Recomendável com pressão mínima de 10 m.c.a para aquecedor de passagem e de acumulação.

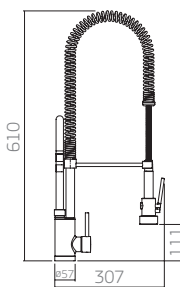
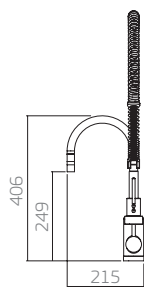

GOURMET



Disponíveis na versão cromado

dimensões em milímetros

UNIUC GOURMET

2282.C
monocomando cozinha
mesa bica móvel

- dois tipos de jatos



Medida aproximada em função da mola.
Recomendável com pressão mínima de 10 m.c.a.

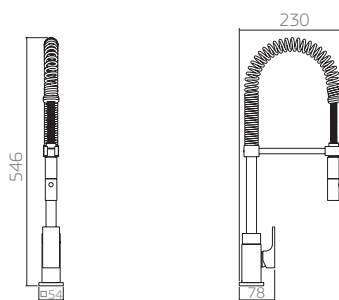

SPIN GOURMET

2281.C
monocomando cozinha
mesa bica móvel

- dois tipos de jatos



Medida aproximada em função da mola.
Recomendável com pressão mínima de 10 m.c.a.

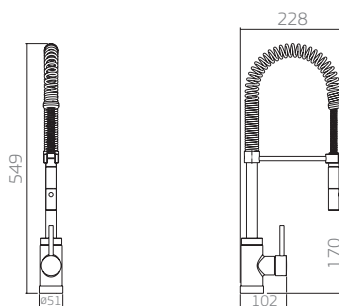

UNIC

2270.C90
monocomando cozinha
mesa bica móvel



Recomendável com pressão mínima de 10 m.c.a. para aquecedor
de passagem e de 4 m.c.a. para aquecedor de acumulação

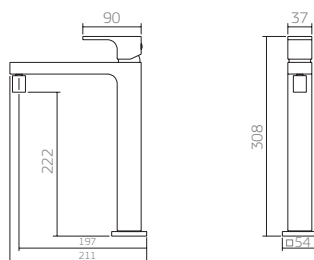

Disponíveis na versão cromado

dimensões em milímetros

2265.C
monocomando cozinha mesa bica móvel

- flexível com alcance de 40 cm

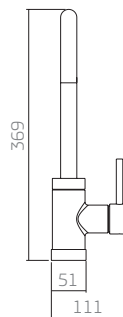
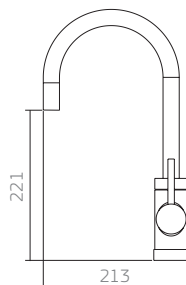

Recomendável com pressão mínima de 10 m.c.a.

2240.C
monocomando com filtro mesa

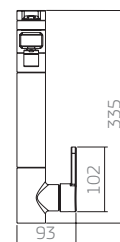
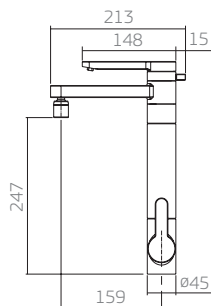

Recomendável com pressão mínima de 6 m.c.a. para aquecedor de passagem e de 2 m.c.a. para aquecedor de acumulação.

2266.C
monocomando cozinha mesa bica móvel

- flexível com alcance de 40cm
- dois tipos de jatos

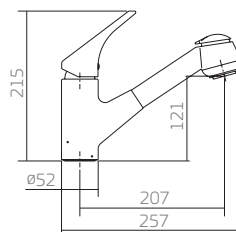

Recomendável com pressão mínima de 10 m.c.a. para aquecedor de passagem e de 2 m.c.a. para aquecedor de acumulação.

Disponíveis na versão cromado

dimensões em milímetros

SPIN MOTION

TWIN

COPPA

SPIN

2279.C72
monocomando cozinha
mesa bica móvel

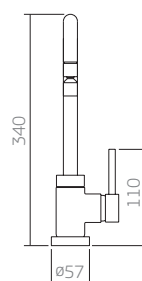
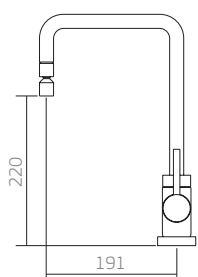

Recomendável com pressão mínima de 10 m.c.a. para aquecedor de passagem e de 4 m.c.a. para aquecedor de acumulação.

PREMIUM

2256.C60
monocomando cozinha
mesa bica móvel

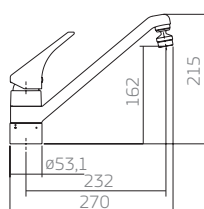

Recomendável com pressão mínima de 6 m.c.a. para aquecedor de passagem e de 2 m.c.a. para aquecedor de acumulação.

PREMIUM

2258.C60
monocomando cozinha
parede móvel

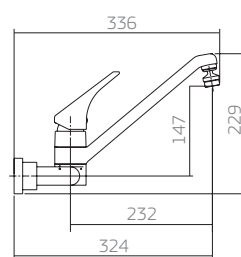
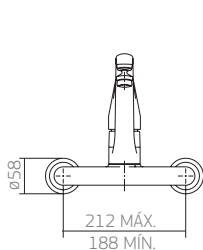

Recomendável com pressão mínima de 6 m.c.a. para aquecedor de passagem e de 2 m.c.a. para aquecedor de acumulação.



Disponíveis na versão cromado

dimensões em milímetros

2268.C36
monocomando cozinha
mesa bica móvel

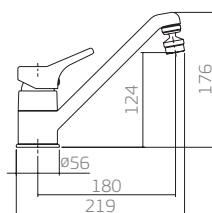

Recomendável com pressão mínima de 6 m.c.a. para aquecedor de passagem e de 2 m.c.a. para aquecedor de acumulação

2256.C.LNK
monocomando cozinha
com arejador articulável

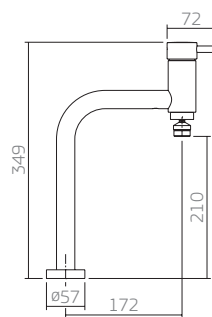

Recomendável com pressão mínima de 10 m.c.a. para aquecedor de passagem e de 2 m.c.a. para aquecedor de acumulação

2268.C71
monocomando cozinha
bica móvel

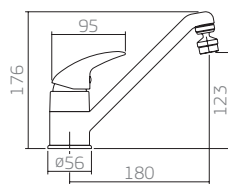

Recomendável com pressão mínima de 6 m.c.a. para aquecedor de passagem e de 2 m.c.a. para aquecedor de acumulação



Disponíveis na versão cromado

dimensões em milímetros

VOGUE PLUS

LINK

SMART



FILTROS

FILTROS

259

Filtros para Cozinha

- A linha de Filtros para cozinha Deca possui design compacto e arrojado, diferente de qualquer opção existente no mercado.
- Preocupada com a saúde e bem-estar de seus usuários, a Deca, em parceria com a 3M desenvolveu o elemento filtrante com a tecnologia Carbon Block. Este elemento filtrante é envolvido por um capsula plástica que protege o meio filtrante, não havendo contato no momento da troca.
- Produzida em metal cromado, a linha de filtros para cozinha Deca, possui a qualidade reconhecida da marca.
- Redução mínima de 75% do cloro – Classe I ($\geq 75\%$) – NBR 14908.
- Redução mínima de 85% das partículas sólidas – Classe III ($\geq 5 < 15 \mu\text{m}$) – NBR 14908.
- Vida útil do elemento filtrante até 1.500 litros, aproximadamente 6 meses (a qualidade de água pode influenciar este período).
- Alta vazão 100 l/h.
- Funciona em alta e baixa pressão.

TWIN

2240.C
monocomando com filtro mesa

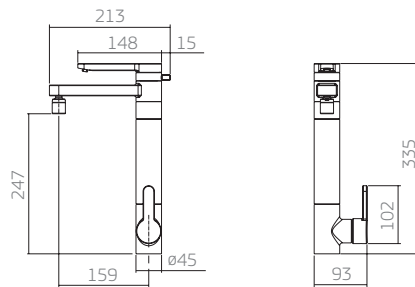

Recomendável com pressão mínima de 6 m.c.a. para aquecedor de passagem e de 2 m.c.a. para aquecedor acumulação.

TWIN

1140.C
torneira com filtro mesa

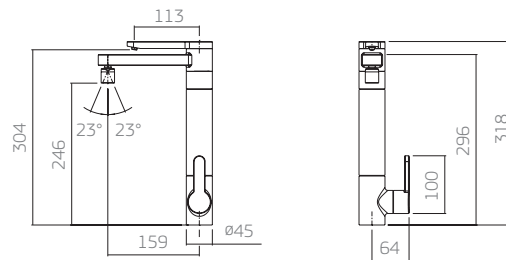

TWIN

1148.C
torneira com filtro parede

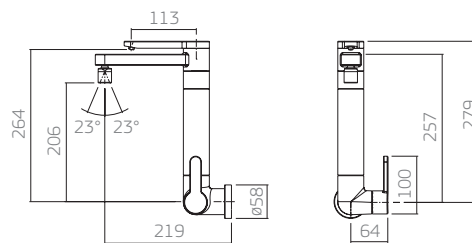

Utilizar a furação no tampo de 35mm para torneiras de mesa.

dimensões em milímetros

COUPLE

1160.C
torneira com filtro parede

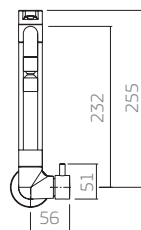
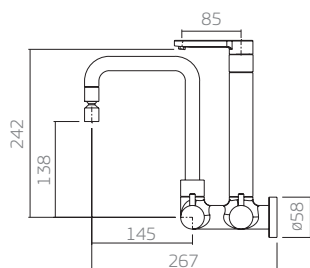

SINGLE

1161.C
filtro de ponto parede

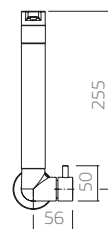
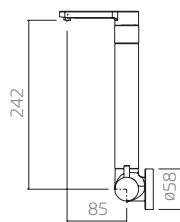

SINGLE DE MESA

1162.C
filtro de ponto mesa

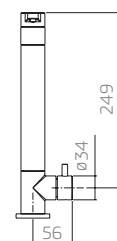
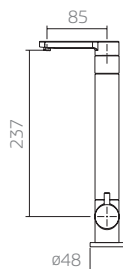

Aparelho para ponto uso em água potável, de acordo com a portaria nº 2914/11 do Ministério da Saúde.
Produtos aprovados pelo Inmetro.
Disponível na versão cromado.
Utilizar a furação no tampo de 35mm para torneira e monocomandos de mesa.

dimensões em milímetros

1330.ENT
filtro de entrada

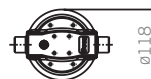
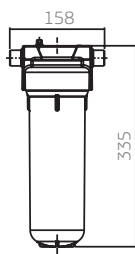

1331.MAQ
filtro para máquina

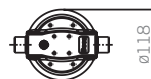
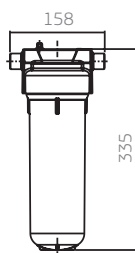

1330.ENT

- Utilizado na entrada de água da residência (cavelete e caixa d'água).
- Evita o entupimento da tubulação, mantém a caixa d'água limpa por mais tempo, protege chuveiros, torneiras e demais registros e evita o disparo da válvula de descarga por incidência de sujeira.
- Retém partículas como areia, barro, ferrugem e outros sedimentos (mínimo de $85\% \geq 15 < 30 \mu\text{m}$) – Classe IV – NBR 14908).
- Mantém o cloro, pois protege a água durante o armazenamento na caixa d'água.
- Vida útil do elemento filtrante aproximadamente 3 meses (a qualidade da água pode influenciar este período).
- Alta vazão 1360 l/h.
- Possui válvula de despressurização que facilita a troca do refil.
- Funciona em alta e baixa pressão.

1331.MAQ

- Utilizado na entrada da máquina de lavar.
- Aumenta a durabilidade dos componentes da máquina de lavar, reduzindo custos com manutenção. Aumenta a eficiência do sabão em pó e conserva as roupas por mais tempo.
- Retém partículas como areia, barro, ferrugem e outros sedimentos (mínimo de $85\% \geq 5 < 15 \mu\text{m}$) – Classe III – NBR 14908).
- Vida útil do elemento filtrante aproximadamente 3 meses (a qualidade da água pode influenciar este período).
- Alta vazão 1360 l/h.
- Possui válvula de despressurização que facilita a troca do refil.
- Funciona em alta e baixa pressão.

Modo de instalação:

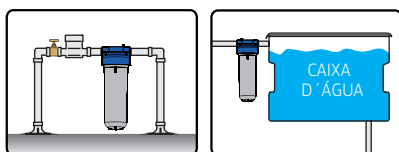

Recomendamos a utilização do POE para aumentar a vida útil e melhorar o desempenho dos seus produtos instalados no sistema hidráulico (torneiras, chuveiros, etc).

Modo de instalação:

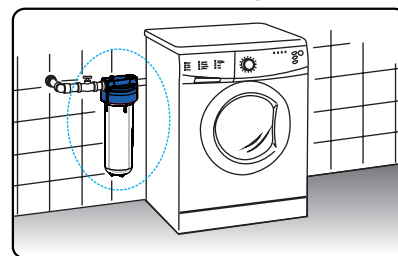

Produtos aprovados pelo Inmetro.

Aparelho para ponto uso em água potável, de acordo com a portaria nº 2914/11 do Ministério da Saúde.

dimensões em milímetros



COZINHA

MONOCOMANDOS	265
FILTROS	271
DUNA QUADRATTA	273
DUNA CLÁSSICA	274
AXIS	275
FAST	276
SKY	277
DISCO	278
STUDIO	279
BELLE ÉPOQUE TRADICIONAL	280
IZY	281
LINK	282
PRATA	284
TARGA	285
SPOT	286
MAX	287
ASPEN	288
TORNEIRAS DE PAREDE	289

DECA SENSE

2295.C.SNS
monocomando cozinha mesa
bica móvel

- flexível com alcance de 40 cm
- dois tipos de jatos

Acionamento ON/OFF por toque, no corpo da bica.

Recomendável com pressão mínima de 18 m.c.a para aquecedor de passagem e de acumulação.

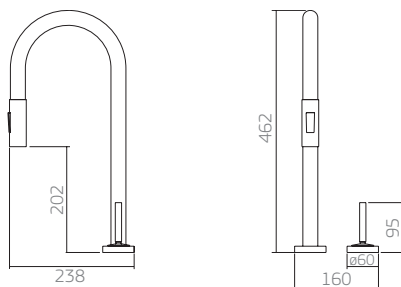

GOURMET

2280.C
monocomando cozinha
mesa bica móvel

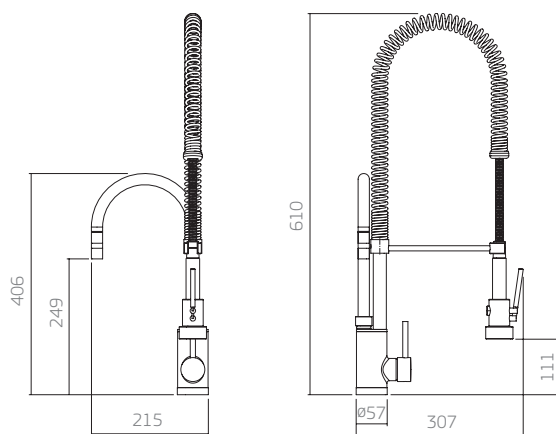

Medida aproximada em função da mola.

Recomendável com pressão mínima de 10 m.c.a.



Disponível na versão cromado.
Diâmetro sugerido dos furos para tampo 37⁺²mm

dimensões em milímetros

UNIC GOURMET

2282.C
monocomando cozinha
mesa bica móvel

- dois tipos de jatos

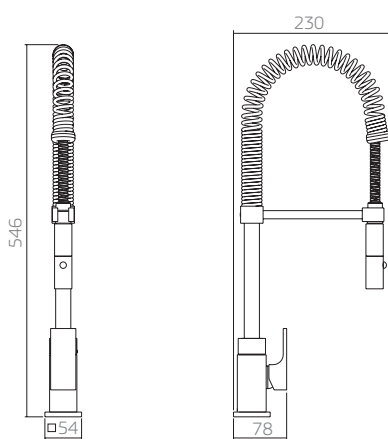

Recomendável com pressão mínima de 10 m.c.a.

SPIN GOURMET

2281.C
monocomando cozinha
mesa bica móvel

- dois tipos de jatos

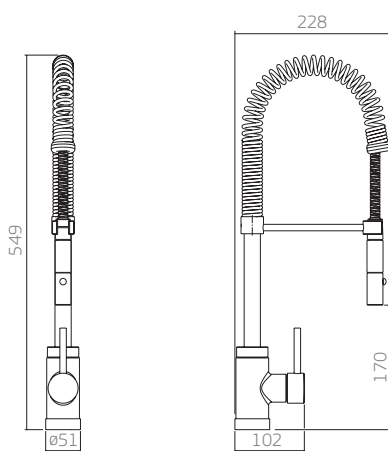

Medida aproximada em função da mola.
Recomendável com pressão mínima de 10 m.c.a.



Disponível na versão cromado.

dimensões em milímetros

UNIC

2270.C90
monocomando cozinha
mesa bica móvel

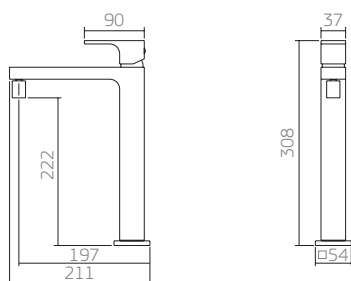

Recomendável com pressão mínima de 10 m.c.a. para aquecedor de passagem e de 4 m.c.a. para aquecedor de acumulação

SPIN MOTION

2265.C
monocomando cozinha mesa bica móvel

- Flexível com alcance de 40 cm

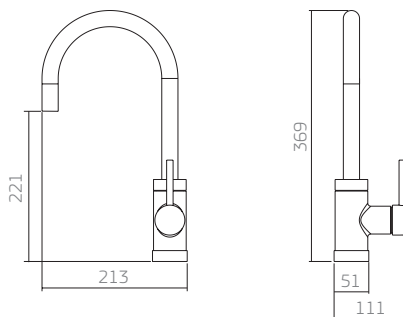

Recomendável com pressão mínima de 10 m.c.a.

COPPA

2266.C
monocomando cozinha mesa bica móvel

- Flexível com alcance de 40cm
- Dois tipos de jatos

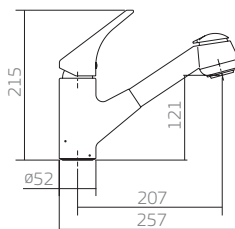

Recomendável com pressão mínima de 10 m.c.a. para aquecedor de passagem e de 2 m.c.a. para aquecedor de acumulação.



Disponível na versão cromado.
Diâmetro sugerido dos furos para tampo 37⁺²mm

dimensões em milímetros

SPIN

2270.C72
monocomando cozinha
mesa bica móvel

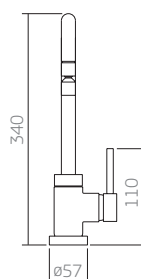
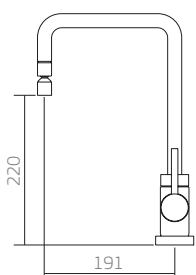

Recomendável com pressão mínima de 10 m.c.a. para aquecedor de passagem e de 4 m.c.a. para aquecedor de acumulação.

TWIN

2240.C
monocomando com filtro mesa

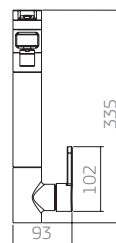
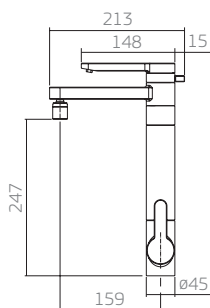

Recomendável com pressão mínima de 6 m.c.a. para aquecedor de passagem e de 2 m.c.a. para aquecedor de acumulação.

PREMIUM

2256.C60
monocomando cozinha
mesa bica móvel

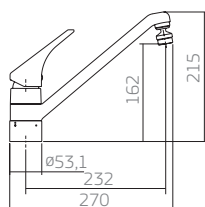

Recomendável com pressão mínima de 6 m.c.a. para aquecedor de passagem e de 2 m.c.a. para aquecedor de acumulação.



Disponíveis na versão cromado.

dimensões em milímetros

PREMIUM

2258.C60
monocomando cozinha
parede móvel

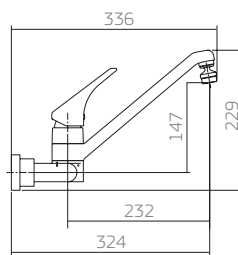
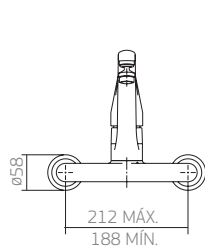

Recomendável com pressão mínima de 6 m.c.a. para aquecedor de passagem e de 2 m.c.a. para aquecedor de acumulação.

VOGUE PLUS

2268.C36
monocomando cozinha
mesa bica móvel

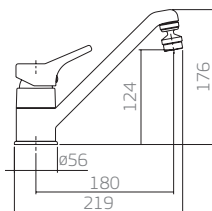

Recomendável com pressão mínima de 6 m.c.a. para aquecedor de passagem e de 2 m.c.a. para aquecedor de acumulação



Disponíveis na versão cromado.

dimensões em milímetros

LINK

2256.C.LNK
monocomando cozinha
com arejador articulável

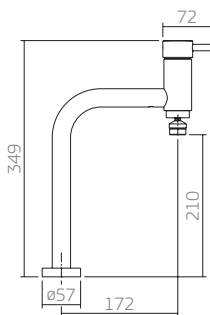

Recomendável com pressão mínima de 10 m.c.a. para aquecedor de passagem e de 2 m.c.a. para aquecedor de acumulação

SMART

2268.C71
monocomando cozinha bica móvel

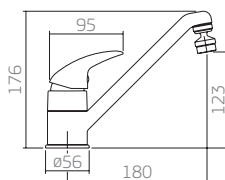

Recomendável com pressão mínima de 6 m.c.a. para aquecedor de passagem e de 2 m.c.a. para aquecedor de acumulação



Disponíveis na versão cromado.

dimensões em milímetros

Filtros para Cozinha

- A linha de Filtros para cozinha Deca possui design compacto e arrojado, diferente de qualquer opção existente no mercado.
- Preocupada com a saúde e bem-estar de seus usuários, a Deca, em parceria com a 3M desenvolveu o elemento filtrante com a tecnologia Carbon Block. Este elemento filtrante é envolvido por um capsula plástica que protege o meio filtrante, não havendo contato no momento da troca.
- Produzida em metal cromado, a linha de filtros para cozinha Deca, possui a qualidade reconhecida da marca.
- Redução mínima de 75% do cloro – Classe I ($\geq 75\%$) – NBR 14908.
- Redução mínima de 85% das partículas sólidas – Classe III ($\geq 5 < 15 \mu\text{m}$) – NBR 14908.
- Vida útil do elemento filtrante até 1.500 litros, aproximadamente 6 meses (a qualidade de água pode influenciar este período).
- Alta vazão 100 l/h.
- Funciona em alta e baixa pressão.

TWIN

2240.C
monocomando com filtro mesa

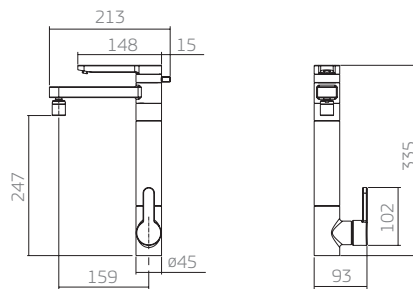

Recomendável com pressão mínima de 6 m.c.a. para aquecedor de passagem e de 2 m.c.a. para aquecedor acumulação.

TWIN

1140.C
torneira com filtro mesa

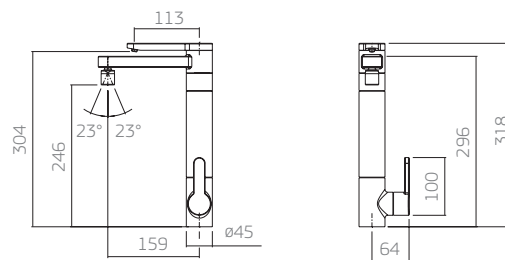

TWIN

1148.C
torneira com filtro parede

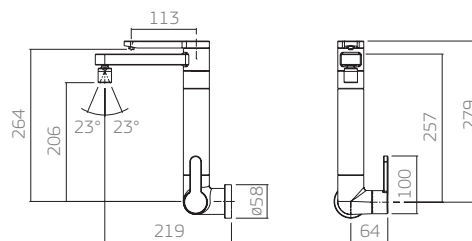

dimensões em milímetros



COUPLE

1160.C
torneira com filtro parede

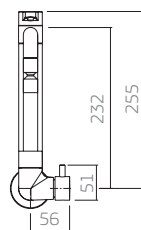
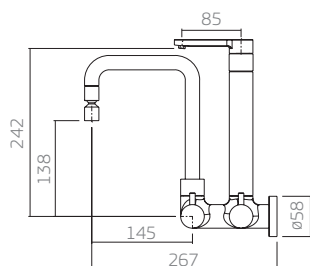

SINGLE

1161.C
filtro de ponto parede

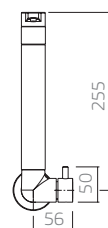
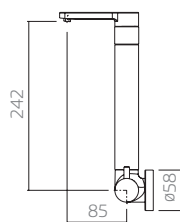

SINGLE

1162.C
filtro de ponto mesa

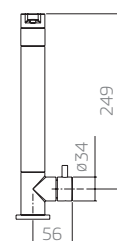
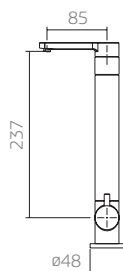

Utilizar a furação no tampo de 35mm para torneiras de mesa.

dimensões em milímetros

- Mecanismo rápido de 2 estágios, que sugere o consumo consciente.

1256.C94
misturador cozinha
mesa bica móvel

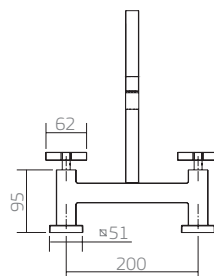
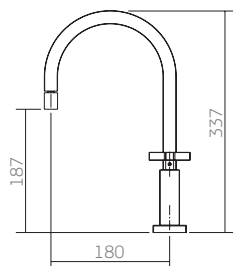

1258.C94
misturador cozinha
parede bica móvel

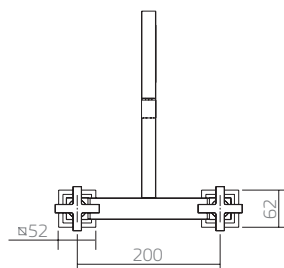
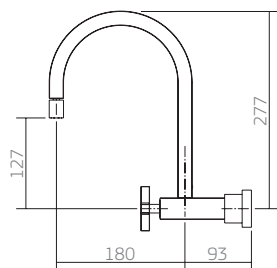

1167.C94
torneira cozinha mesa
bica móvel

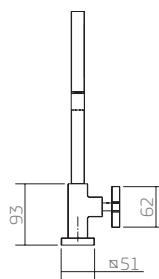
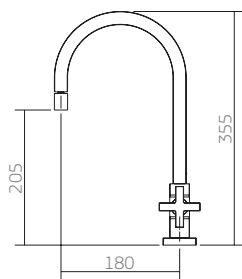

1168.C94
torneira cozinha
parede bica móvel

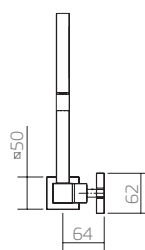
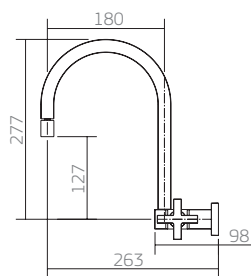

Disponível na versão cromado.
Utilizar a furação no tampo de 35mm para misturadores e torneiras de mesa.

dimensões em milímetros

DUNA CLÁSSICA

1256.C64
misturador cozinha
mesa bica móvel

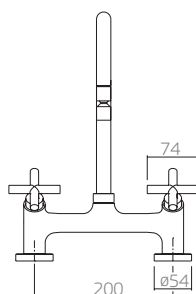
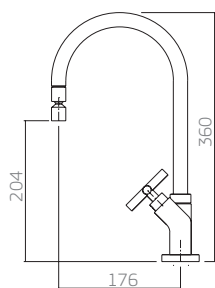

1258.C64
misturador cozinha
parede bica móvel

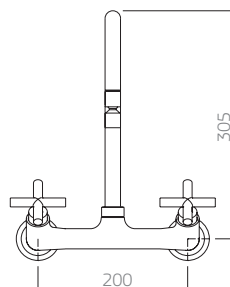
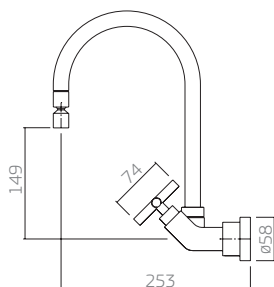

1167.C64
torneira cozinha
mesa bica móvel

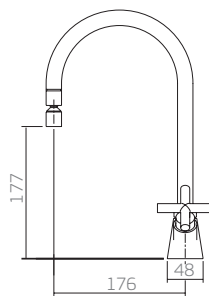
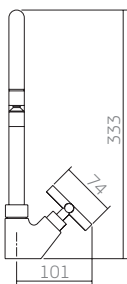

1168.C64
torneira cozinha
parede bica móvel

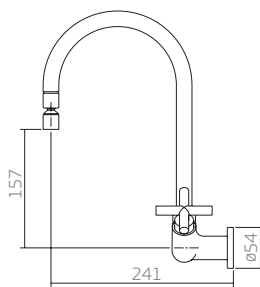
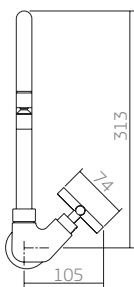

Disponível na versão cromado.
Utilizar a furação no tampo de 35mm para misturadores e torneiras de mesa.

dimensões em milímetros

1256.C73
misturador cozinha
mesa bica móvel

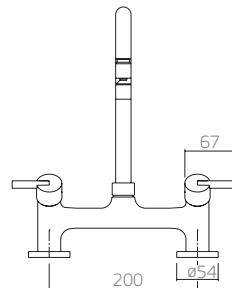
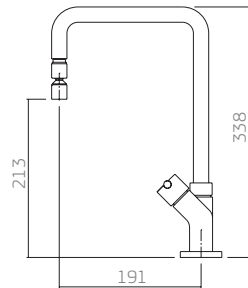

1258.C73
misturador cozinha
parede bica móvel

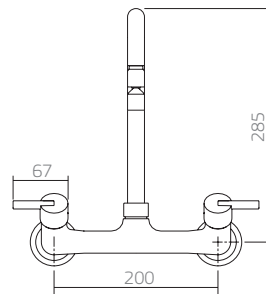
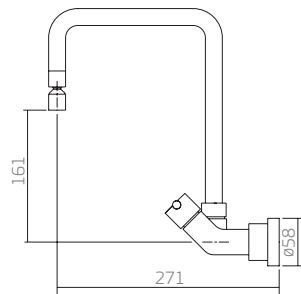

1167.C73
torneira cozinha mesa
bica móvel

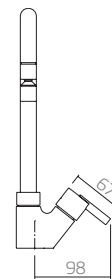
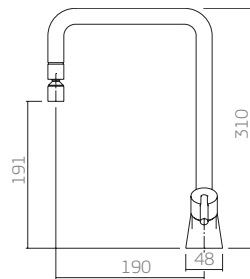

1168.C73
torneira cozinha
parede bica móvel

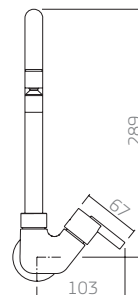
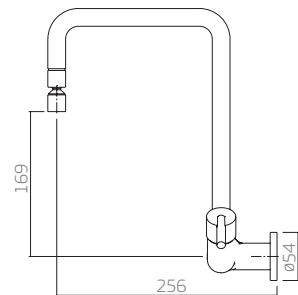

Disponível na versão cromado.
Utilizar a furação no tampo de 35mm para misturadores e torneiras de mesa.

dimensões em milímetros

1256.C59
misturador cozinha
mesa bica móvel

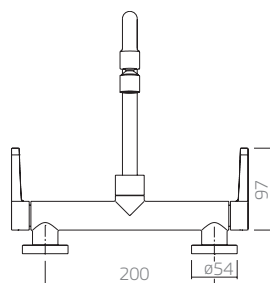
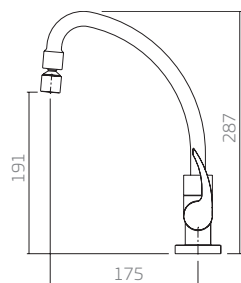

1258.C59
misturador cozinha
parede bica móvel

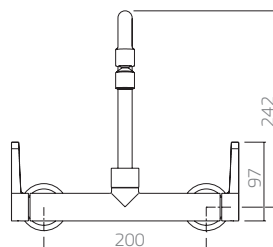
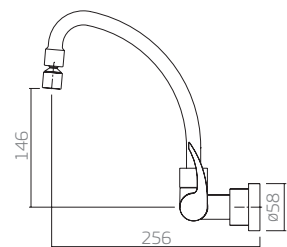

1167.C59
torneira cozinha
mesa bica móvel

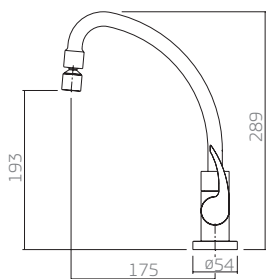

1168.C59
torneira cozinha
parede bica móvel

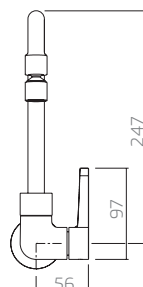
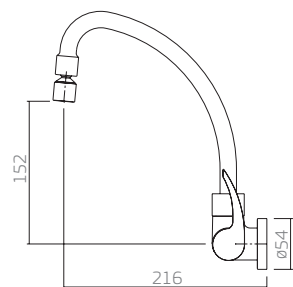

Disponível na versão cromado.
Utilizar a furação no tampo de 35mm para misturadores e torneiras de mesa.

dimensões em milímetros

1256.C25
misturador cozinha
mesa bica móvel

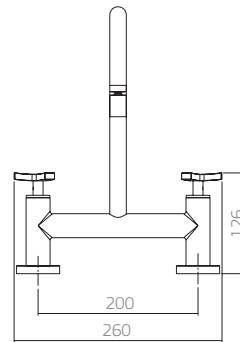
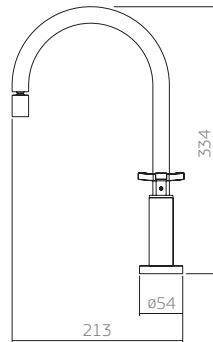

1258.C25
misturador cozinha
parede bica móvel

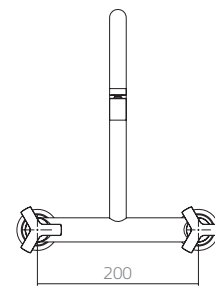
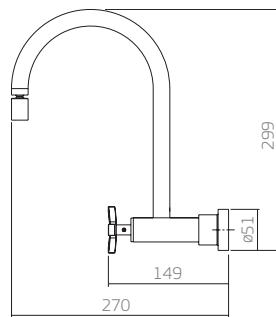

1167.C25
torneira cozinha
mesa bica móvel

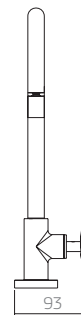
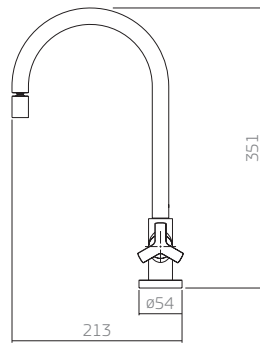

1168.C25
torneira cozinha
parede bica móvel

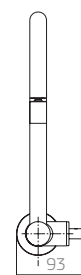
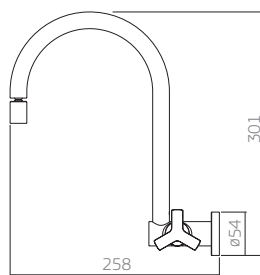

Disponível na versão cromado.

dimensões em milímetros

Utilizar furação no tampo de 35mm para misturadores e torneiras de mesa.

1256.C.DSC
misturador cozinha
mesa bica móvel

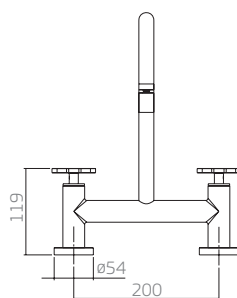
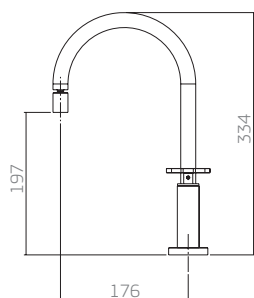

1258.C.DSC
misturador cozinha
parede bica móvel

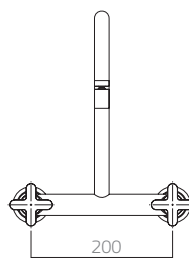
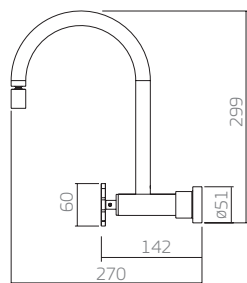

1167.C.DSC
torneira cozinha mesa
bica móvel

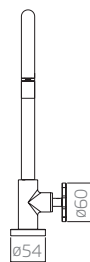
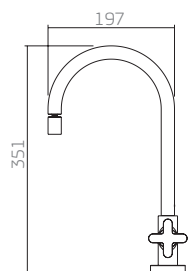

1168.C.DSC
torneira cozinha
parede bica móvel

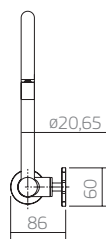
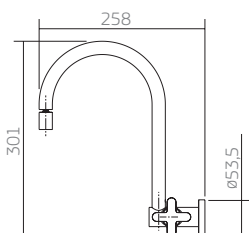

Disponível na versão cromado.
Utilizar furação no tampo de 35mm para misturadores e torneiras de mesa.

dimensões em milímetros

1256.C46
misturador cozinha
mesa bica móvel

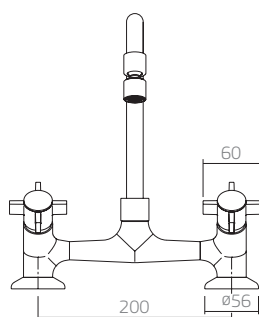
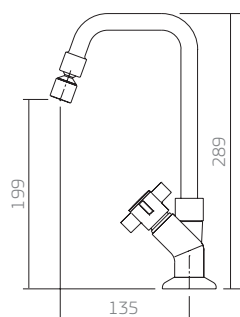

1258.C46
misturador cozinha
parede bica móvel

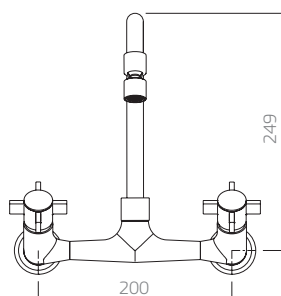
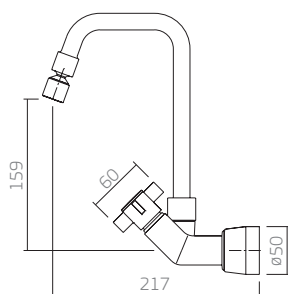

1167.C46
torneira cozinha mesa
bica móvel

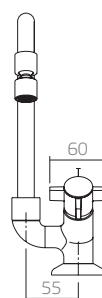
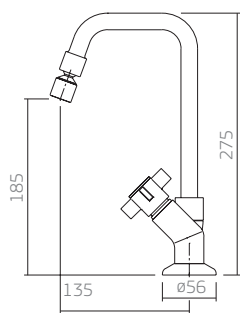

1168.C46
torneira cozinha
parede bica móvel

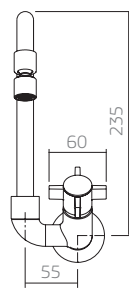
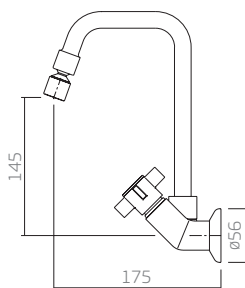

Disponível na versão cromado.
Utilizar a furação no tampo de 35mm para misturadores e torneiras de mesa.

dimensões em milímetros

1256.C52
misturador cozinha
mesa bica móvel

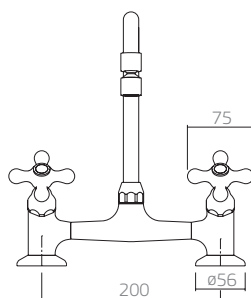
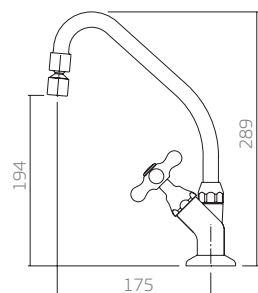

1258.C52
misturador cozinha
parede bica móvel

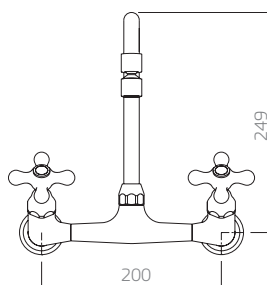
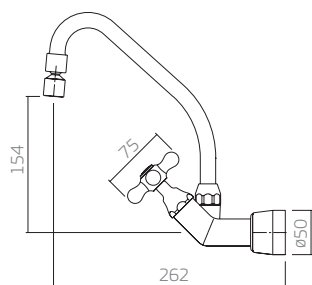

1167.C52
torneira cozinha mesa
bica móvel

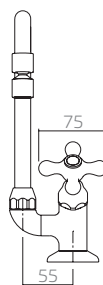
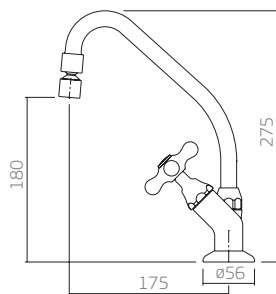

1168.C52
torneira cozinha
parede bica móvel

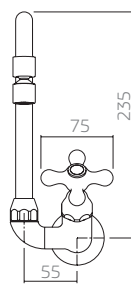
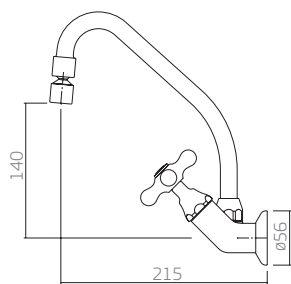

Disponível na versão cromado.
Utilizar a furação no tampo de 35mm para misturadores e torneiras de mesa.

dimensões em milímetros

1256.C37
misturador cozinha
mesa bica móvel

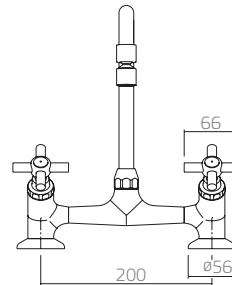
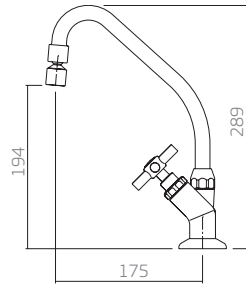

1258.C37
misturador cozinha
parede bica móvel

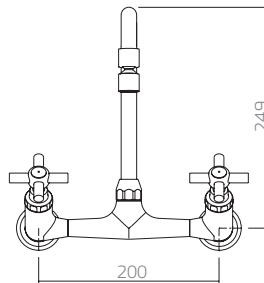
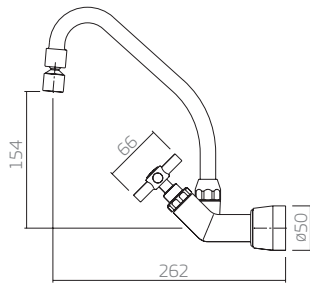

1167.C37
torneira cozinha mesa
bica móvel

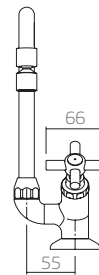
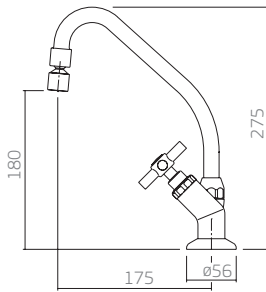

1168.C37
torneira cozinha
parede bica móvel

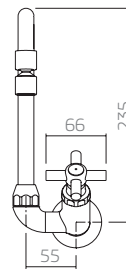
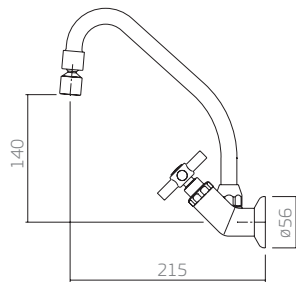

Disponível na versão cromado.
Utilizar a furação no tampo de 35mm para misturadores e torneiras de mesa.

dimensões em milímetros

1159.C.LNK
torneira cozinha parede com arejador

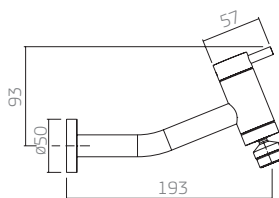

1168.C.LNK
torneira cozinha parede bica móvel

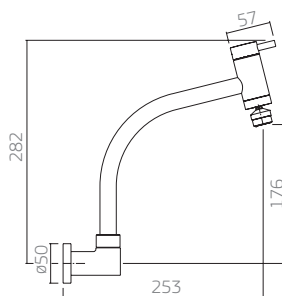

1167.C.LNK
torneira cozinha mesa bica móvel

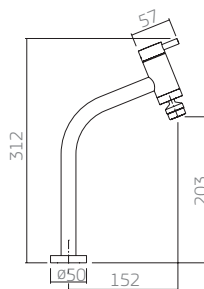

Disponível na versão cromado.
Utilizar a furação no tampo de 35mm para misturadores e torneiras de mesa.

dimensões em milímetros

1166.C.LNK
torneira cozinha mesa tubo bica móvel 90°
com arejador articulado

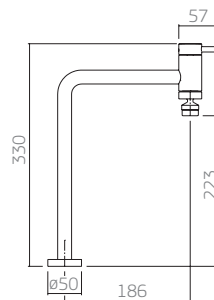

1169.C.LNK
torneira cozinha mesa tubo telescópico

- permite regulagem de altura

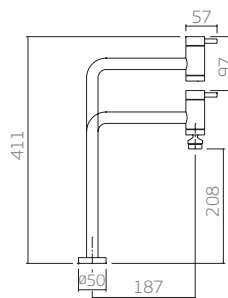

Disponível na versão cromado.
Utilizar a furação no tampo de 35mm para misturadores e torneiras de mesa.

dimensões em milímetros

1256.C50
misturador cozinha
mesa bica móvel

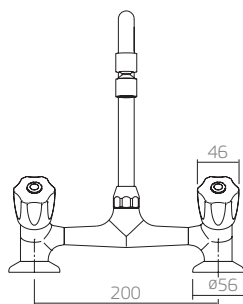
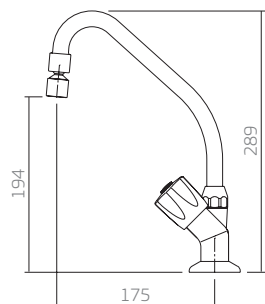

1258.C50
misturador cozinha
parede bica móvel

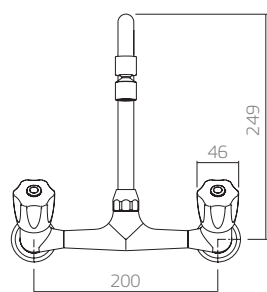
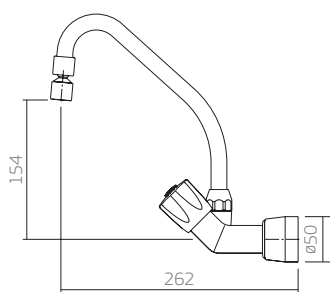

1167.C50
torneira cozinha mesa
bica móvel

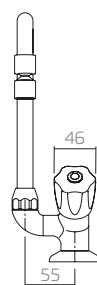
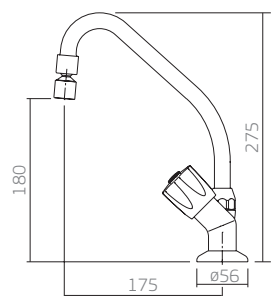

1168.C50
torneira cozinha
parede bica móvel

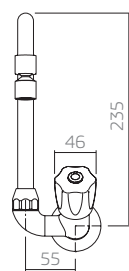
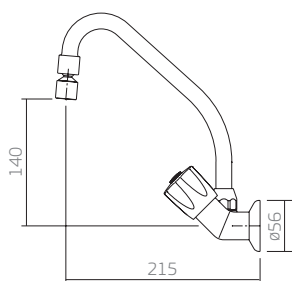

Disponível na versão cromado.
Utilizar a furação no tampo de 35mm para misturadores e torneiras de mesa.

dimensões em milímetros

1256.C40.CR
misturador cozinha
mesa bica móvel

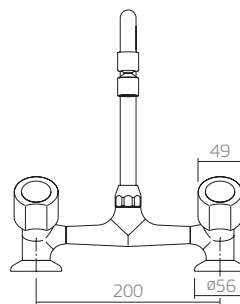
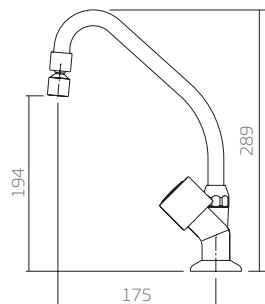

1258.C40.CR
misturador cozinha
parede bica móvel

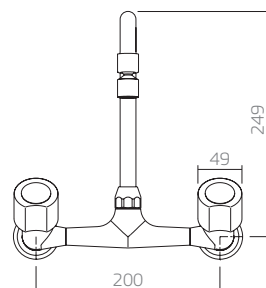
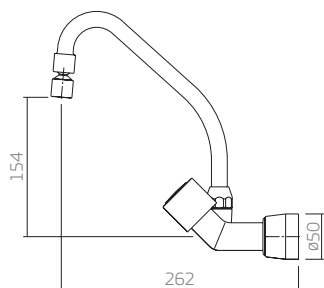

1167.C40.CR
torneira cozinha
mesa bica móvel

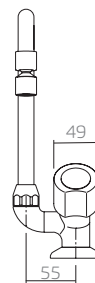
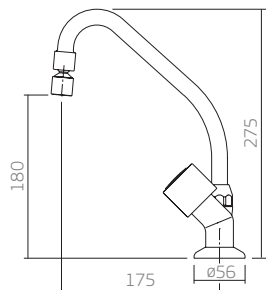

1168.C40.CR
torneira cozinha
parede bica móvel

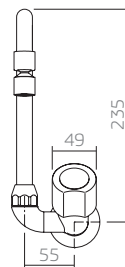
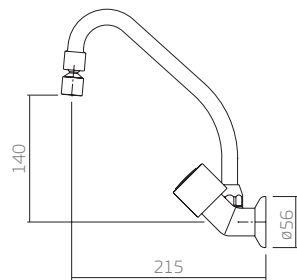

Disponível na versão cromado.
Utilizar a furação no tampo de 35mm para misturadores e torneiras de mesa.

dimensões em milímetros

1256.C43
misturador cozinha
mesa bica móvel

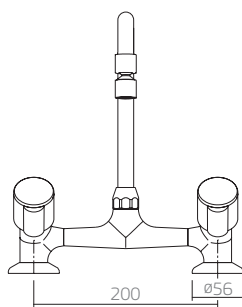
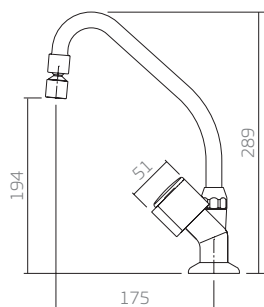

1258.C43
misturador cozinha
parede bica móvel

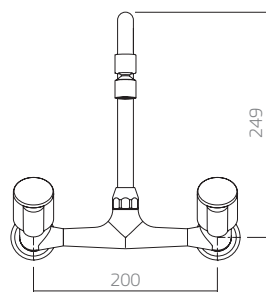
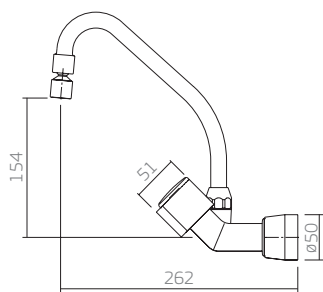

1167.C43
torneira cozinha
mesa bica móvel

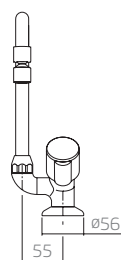
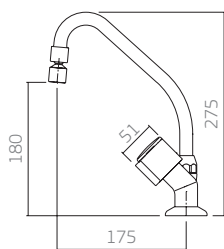

1168.C43
torneira cozinha
parede bica móvel

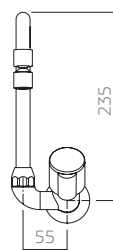
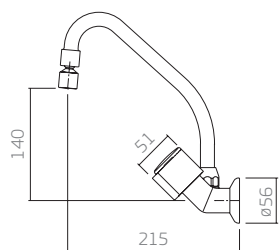

Disponível na versão cromado.
Utilizar a furação no tampo de 35mm para misturadores e torneiras de mesa.

dimensões em milímetros

1256.C34
misturador cozinha
mesa bica móvel

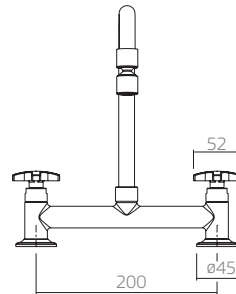
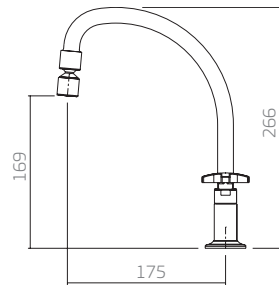

1258.C34
misturador cozinha
parede bica móvel

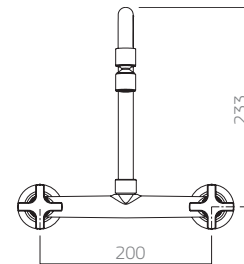
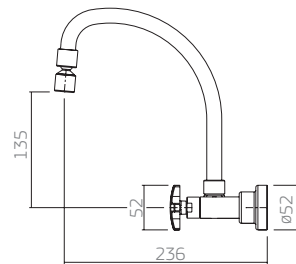

1167.C34
torneira cozinha
mesa bica móvel

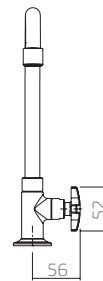
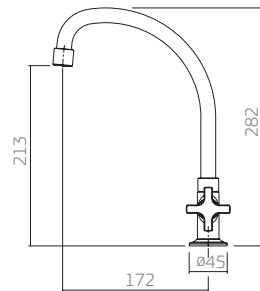

1168.C34
torneira cozinha
parede bica móvel

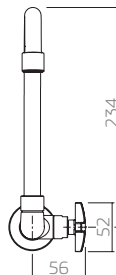
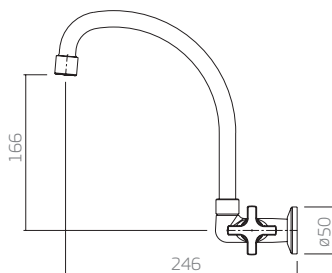

Utilizar a furação no tampo de 35mm para misturadores e torneiras de mesa.

dimensões em milímetros

1256.C35
misturador cozinha
mesa bica móvel

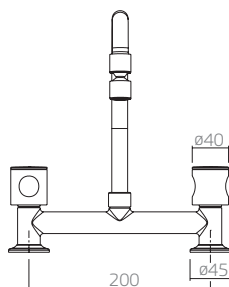
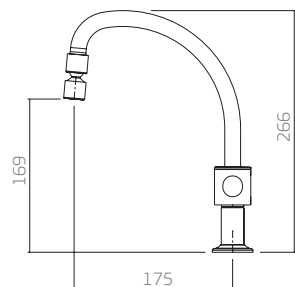

1258.C35
misturador cozinha
parede bica móvel

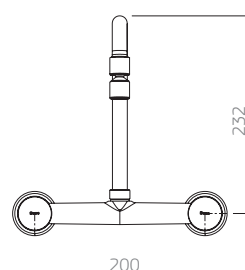
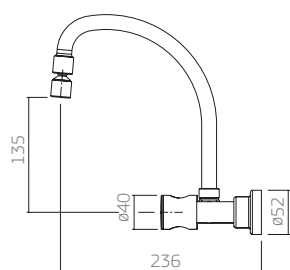

1167.C35
torneira cozinha
mesa bica móvel
com arejador

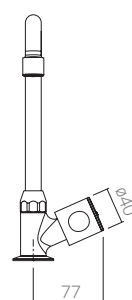
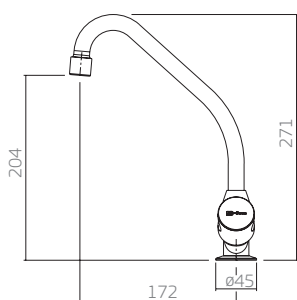

1168.C35
torneira cozinha
parede bica móvel
com arejador

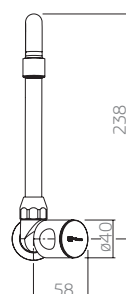
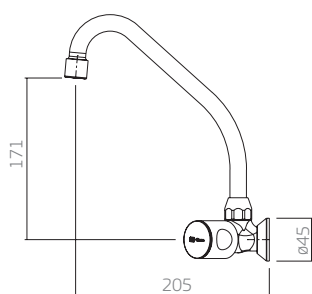

Disponível na versão cromado.
Utilizar a furação no tampo de 35mm para misturadores e torneiras de mesa.

dimensões em milímetros

IZY

1159.C37
torneira cozinha
parede com arejador

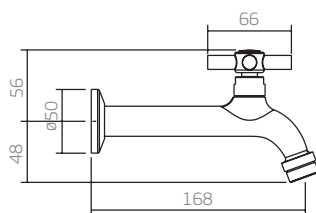
**TARGA**

1159.C40.CR
torneira cozinha
parede com arejador

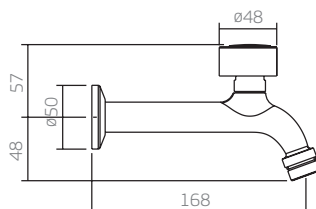
**STANDARD**

1159.C39
torneira cozinha
parede com arejador

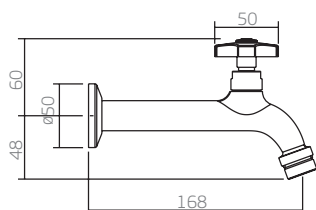
**BELLE ÉPOQUE LIGHT**

1159.C51
torneira cozinha
parede com arejador

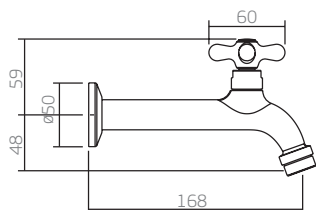

Disponível na versão cromado.

dimensões em milímetros



BANHO

DECA SPA ENJOY	293
SPA DECA	294
DECA TWIN SPA	295
DECA SPA CASCATA	296
CHROMO	297
QUADRADO	298
REDONDO	299
AQUAMAX	300
MISTURADOR EXTERNO	301
CUBO	302
DECA AQUA	303
DREAM	304
ACQUA PLUS QUADRATTA	305
ACQUA PLUS	306
BALANCE 12	307
WINDSOR	308
BELLE ÉPOQUE	309
KIDS	310
BALANCE 5	311
CHUÁ	312
MAX	313
BALANCE 6	314
CLEAN	315
IZY	315
ASPEN	316
SPOT	316
DUCHA LATERAL	317
DESVIADORES	318
BARRAS DESLIZANTES	319
DUCHA LATERAL	320
DUCHA MANUAIS	320



- Design ultra slim.
- Viva a experiência única de um banho com o chuveiro de cerca de um metro quadrado.
- Proporciona um banho confortável e envolvente.
- Possui 3 tipos de jatos: central, lateral e nebulizador.
- Chuveiro em aço inox polido.

2103.C.TET.ENJ
chuveiro de teto

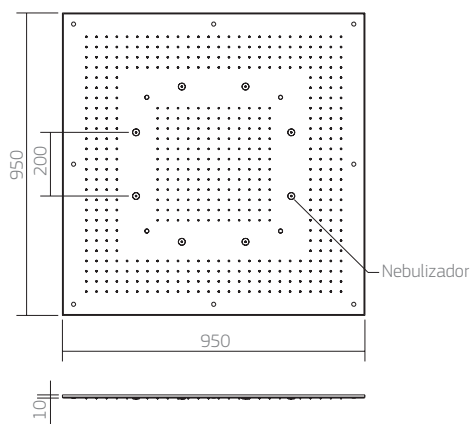

Disponível na versão cromado.
Pressão mínima de funcionamento 20 m.c.a
Este produto exige instalações hidráulicas próprias.

dimensões em milímetros

- O efeito colorido da água é proporcionado por "LED's" (fontes luminosas de alta eficiência).
- 07 variações de cores.
- Possibilidade de utilizar os jatos (interno e externo) de forma independente.
- Baixo consumo de energia (6w).
- Crivos salientes - permite fácil limpeza.
- Acionamento através de uma leve toque.
- Pressão mínima de funcionamento 18 m.c.a.
- A distância máxima do acionamento é de 3 m.
- Não deve ser instalado em saunas e área externa.

2100.C.TET chuveiro de teto

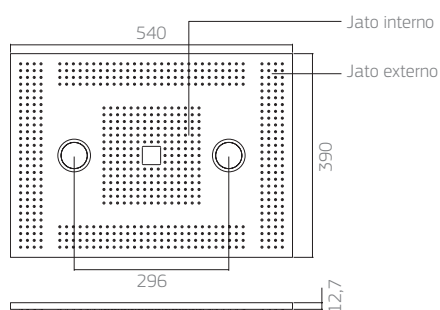

Controle de
acionamento



Disponível nas versões cromado e gold.
Voltagem: bivolt
Este produto exige instalações hidráulicas e elétricas próprias.

dimensões em milímetros

- Design ultra slim. Elegância nos mínimos detalhes.
- Possui duas opções de jatos: jato normal e cascata.
- Viva a experiência de um banho de cachoeira em sua casa.

1978.C.CT.TWN
chuveiro de parede

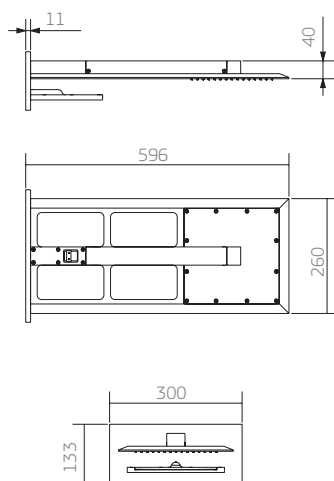
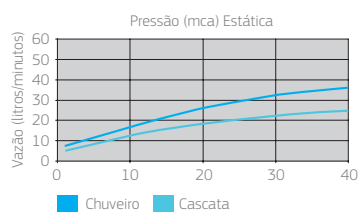

1978.C.TET.TWN
chuveiro de teto

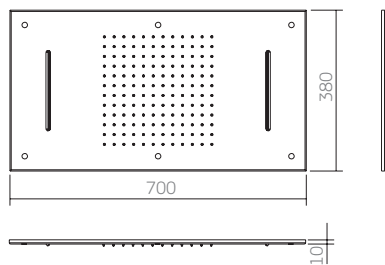

dimensões em milímetros



Disponível na versão cromado.

Disponibilidade do produto para venda condicionada ao prazo de fabricação.

Pressão mínima de funcionamento 18 m.c.a, para aquecedor de passagem e de acumulação.



- O design Slim traz sofisticação ao banheiro.
- Possui um incomparável jato linear proporcionando um incomparável conforto.

2102.C.CAS
chuveiro de parede

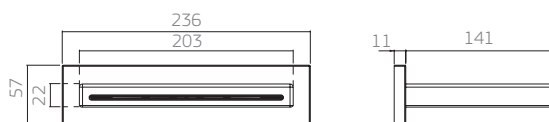
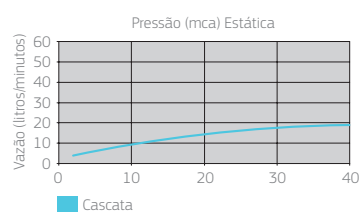

2170.C.CAS
bica para banheira

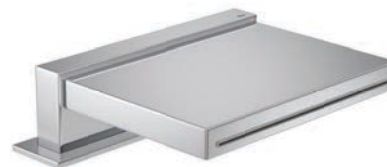
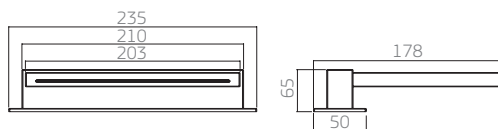

Disponível na versão cromado.

dimensões em milímetros

Recomendável com pressão mínima de 18 m.c.a para aquecedor de passagem e de 10 m.c.a para aquecedor de acumulação.

- O conforto do banho aliado com o poder relaxante das cores.
- 07 variações de cores.
- O efeito colorido da água é proporcionado por "LED's" (fontes luminosas de alta eficiência).
- Controle blindado evitando que a água entre em seus comandos
- Acionamento através de um leve toque.
- Baixo consumo de energia aproximadamente 6w.
- Excelente performance em alta e baixa pressão.
- Seu diâmetro proporciona um banho confortável e envolvente.
- Crivos salientes - permitem fácil limpeza.
- A distância máxima do acionamento é de 3 m.
- Não deve ser instalado em saunas e área externa.

O poder das cores*

AZUL
harmonia, tranquilidade, contemplação

CIAN
sabedoria, discernimento, concentração

VERDE
esperança, equilíbrio, amor

AMARELO
otimismo, criatividade, coragem

VERMELHO
vitalidade, autoconfiança, realização

VIOLETA
intuição, contemplação, expansão

BRANCO
soma de todas as cores

* segundo a Cromoterapia

1979.C.CT
chuveiro com tubo parede

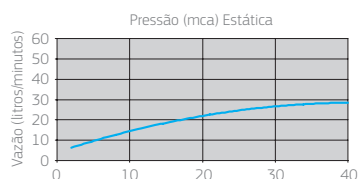

1979.C.TET
chuveiro com tubo teto

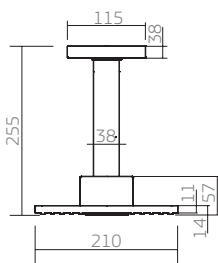
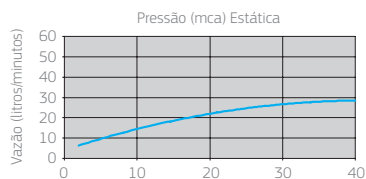

Controle de acionamento



Disponível na versão cromado.

dimensões em milímetros

Recomendável com pressão mínima de 6 m.c.a. para aquecedor de passagem e de 4 m.c.a. para aquecedor de acumulação.

Voltagem: bivolt.

Este produto exige instalações hidráulicas e elétricas próprias.

- Seu tamanho proporciona um banho confortável e envolvente.
- Crivos salientes - permitem fácil limpeza.

1992.C.CT* chuveiro com tubo parede

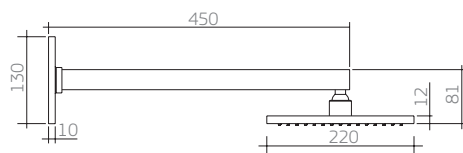
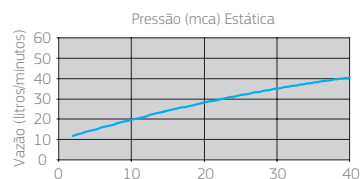

1992.C.TET* chuveiro com tubo teto

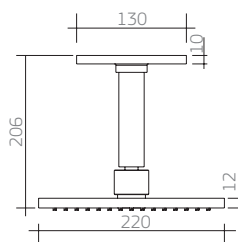
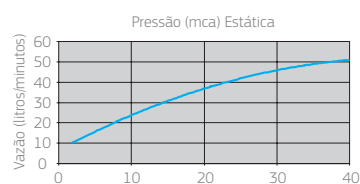

1992.C.DES chuveiro com desviador e ducha manual

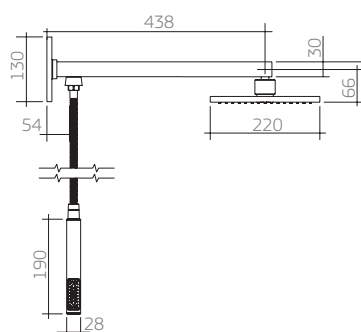
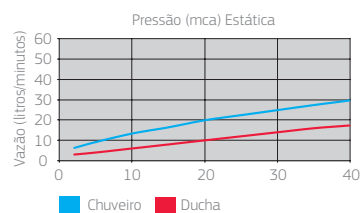

Disponível na versão cromado.

Recomendável com pressão mínima de 8 m.c.a para aquecedor de passagem e de 4 m.c.a para aquecedor de acumulação.
Comprimento do flexível 1,80 m.



Disponível na versão cromado, preto fosco e gold.

dimensões em milímetros

* Recomendável com pressão mínima de 6 m.c.a. para aquecedor de passagem e de 4 m.c.a. para aquecedor de acumulação.

- Seu diâmetro proporciona um banho confortável e envolvente.
- Crivos salientes - permitem fácil limpeza.

1997.C.CT
chuveiro com tubo parede

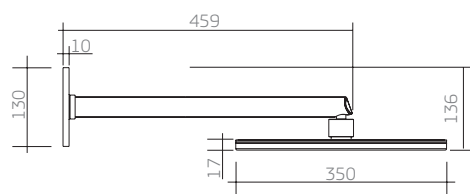
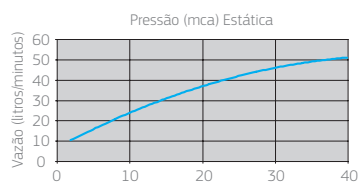

1997.C.TET
chuveiro com tubo teto

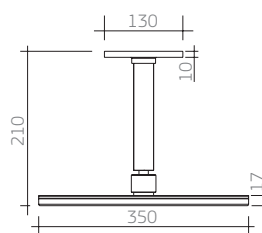
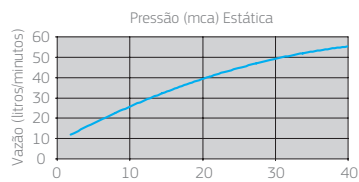

dimensões em milímetros



Disponível na versão cromado.

Recomendável com pressão mínima de 6 m.c.a. para aquecedor de passagem e de 4 m.c.a. para aquecedor de acumulação.

- Seu diâmetro proporciona um banho confortável e envolvente.
- Crivos salientes - permitem fácil limpeza.

1998.C.CT chuveiro com tubo parede

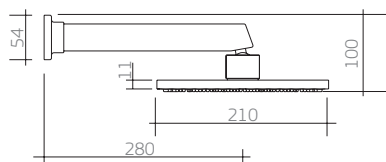
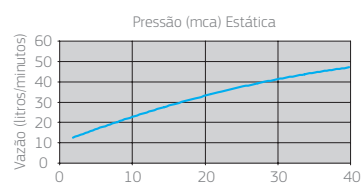

1998.C.TET chuveiro com tubo teto

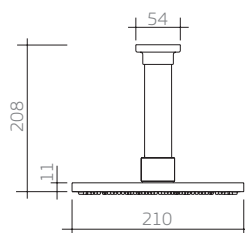
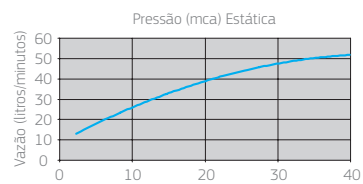

Disponível na versão cromado, dourado e gold.

dimensões em milímetros

Recomendável com pressão mínima de 10 m.c.a. para aquecedor de passagem e de 2 m.c.a. para aquecedor de acumulação.

1440.C64
misturador externo para chuveiro

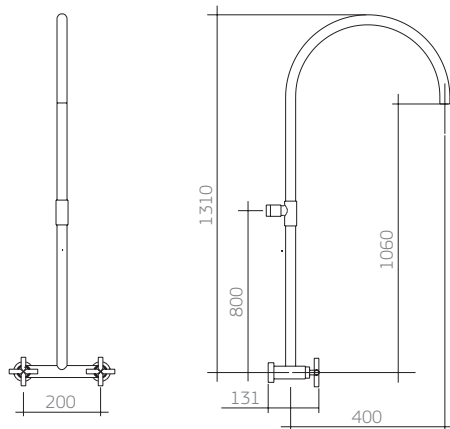

Chuveiros vendidos separadamente

1976.C.ST
chuveiro Dream sem tubo

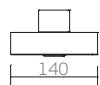

1997.C.ST
chuveiro Redondo sem tubo

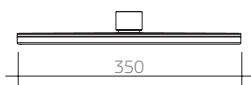

1990.C.ST
chuveiro Acqua Plus sem tubo



1998.C.ST
chuveiro Aquamax sem tubo

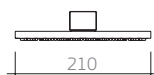

Disponível na versão cromado.

dimensões em milímetros

- Excelente performance em alta e baixa pressão.
- Jato intenso e relaxante.
- Crivos salientes - permitem fácil limpeza.
- Possui tecnologia que limita o consumo de água em até 22 litros/minuto, evita o desperdício.

1985.C.CT chuveiro com tubo parede

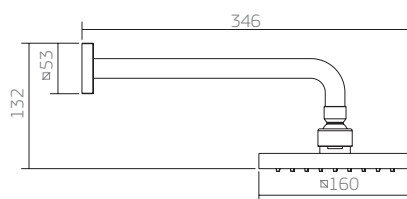
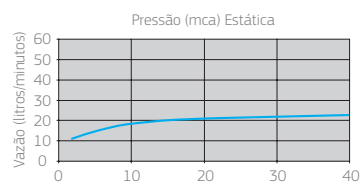

Disponível na versão cromado.

Recomendável com pressão mínima de 2 m.c.a para aquecedor de passagem e de acumulação.

dimensões em milímetros

- Possui sistema "autolimpante", ativado sempre que a água for fechada.

1974.C.CT
 chuveiro com tubo parede

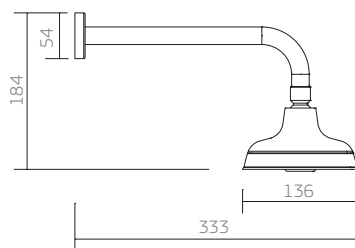
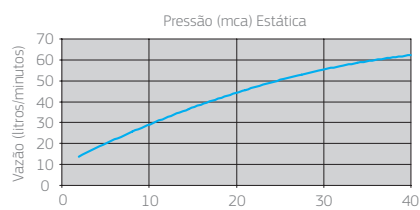

Disponível nas versões cromado e dourado.

dimensões em milímetros

Recomendável com a pressão mínima de 6 m.c.a. para aquecedor de passagem e de 2 m.c.a. para aquecedor de acumulação.

- Possui sistema "autolimpante", ativado sempre que a água for fechada.

1976.C.CT
chuveiro com tubo parede

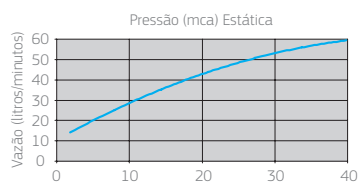

1976.C.TET
chuveiro com tubo teto

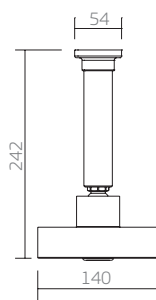
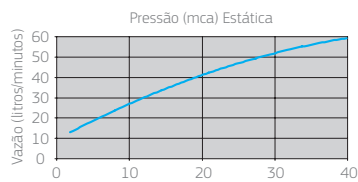

Disponível na versão cromado e dourado.

dimensões em milímetros

Recomendável com a pressão mínima de 8 m.c.a. para aquecedor de passagem e de 2 m.c.a. para aquecedor de acumulação.

- Jato forte, excelente vazão de água e conforto no banho.
- Possui sistema "autolimpante" ativado sempre que a água for fechada.

1990.C.CT.QUA chuveiro com tubo parede

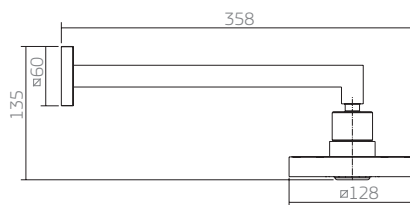
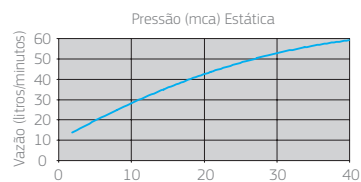

Disponível na versão cromado.

dimensões em milímetros

Recomendável com a pressão mínima de 6 m.c.a. para aquecedor de passagem e de 2 m.c.a. para aquecedor de acumulação.

- Possui sistema "autolimpante", ativado sempre que a água for fechada.

1990.C.CT chuveiro com tubo parede

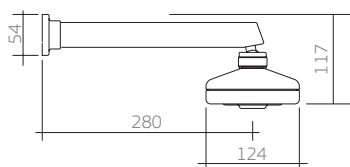
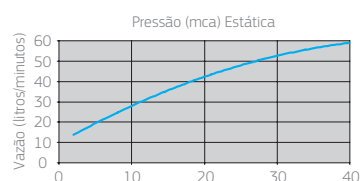

Recomendável com a pressão mínima de 8 m.c.a. para aquecedor de passagem e de 4 m.c.a. para aquecedor de acumulação.

1990.C.TET chuveiro com tubo teto

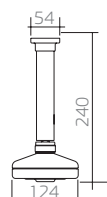
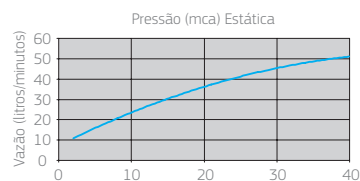

Recomendável com a pressão mínima de 8 m.c.a. para aquecedor de passagem e de 4 m.c.a. para aquecedor de acumulação.

1990.C.STD chuveiro com tubo parede

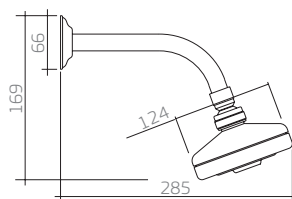
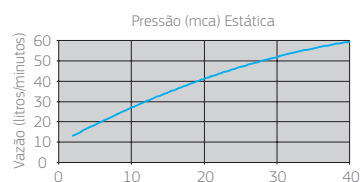

Recomendável com a pressão mínima de 6 m.c.a. para aquecedor de passagem e de 4 m.c.a. para aquecedor de acumulação.



Disponível nas versões cromado e dourado.

dimensões em milímetros

- Jato que mistura água e ar, economiza água sem perder o conforto do banho.
- Consome 12 litros de água por minuto.

1957.C.CT.ARE

chuveiro com 1 jato com tubo parede

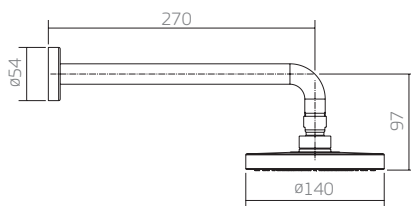
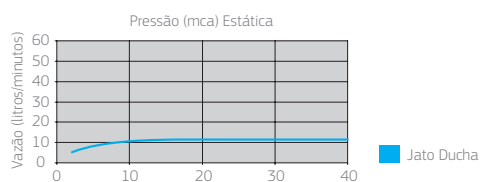

Até
40%
de economia
de água.

1957.C.TET.ARE

chuveiro com 1 jato com tubo teto

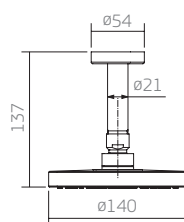
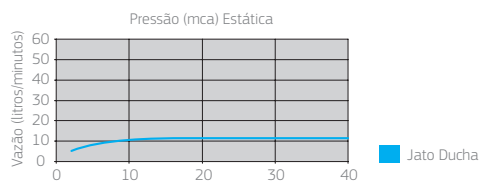

Até
40%
de economia
de água.



Disponível na versão cromado.

dimensões em milímetros

Recomendável com a pressão mínima de 10 m.c.a para aquecedor de passagem e de 2 m.c.a. para aquecedor de acumulação.

- Jato que mistura água e ar, economiza água sem perder o conforto do banho.
- Consome 12 litros de água por minuto.
- 2 opções de jato.

1958.C.CT.ARE chuveiro com 2 jatos com tubo parede

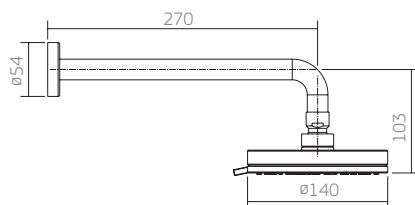
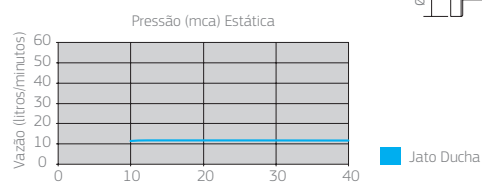

Até
40%
de economia
de água.

1958.C.TET.ARE chuveiro com 2 jatos com tubo teto

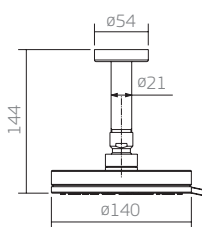
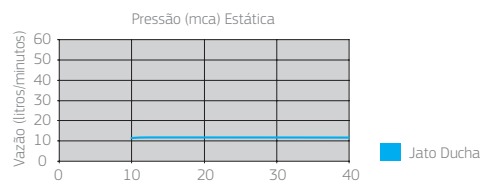

Até
40%
de economia
de água.



Disponível na versão cromado.

dimensões em milímetros

Recomendável com a pressão mínima de 10 m.c.a para aquecedor de passagem e de 2 m.c.a. para aquecedor de acumulação.

1994.C81.CT
 chuveiro com tubo parede

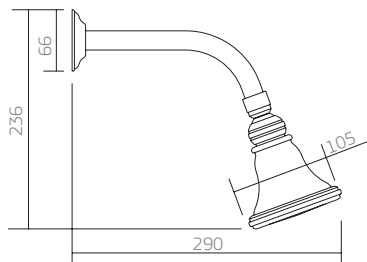
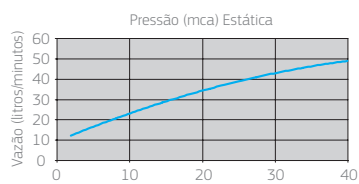

Disponível nas versões cromado e dourado.



WINDSOR

1994.C.CT
 chuveiro com tubo parede

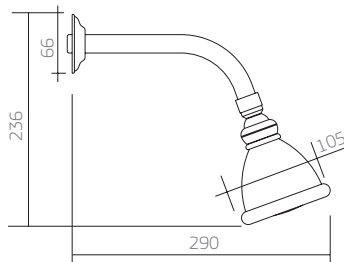
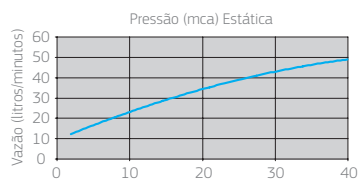

Disponível nas versões cromado, cromado com dourado e dourado.



BELLE ÉPOQUE



Recomendável com pressão mínima de 10 m.c.a para aquecedor de passagem e de 2 m.c.a. para aquecedor de acumulação.

dimensões em milímetros



1975.VA.KD
 chuveiro com desviador e
 ducha manual

1975.VB.KD
 chuveiro com desviador e
 ducha manual

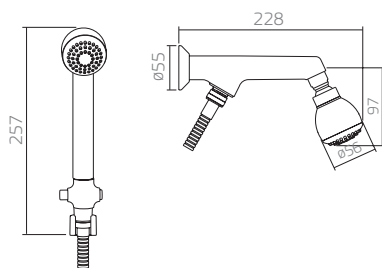
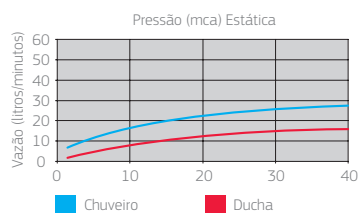

1973.VA.CT.KD
 chuveiro com tubo

1973.VB.CT.KD
 chuveiro com tubo

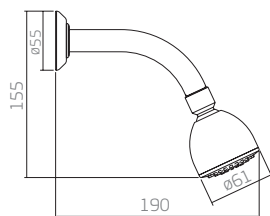
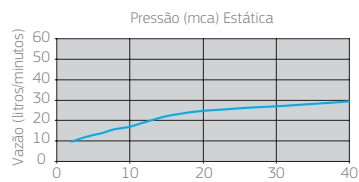

Recomendável com pressão mínima de 4 m.c.a para aquecedor de passagem e de 2 m.c.a. para aquecedor de acumulação.

dimensões em milímetros

- Cinco diferentes opções de jatos: nebulizador, massageador, tradicional, combinação tradicional + nebulizador e combinação tradicional + massageador.
- Exclusivo jato nebulizador, efeito de uma nuvem de água.

1963.C.CT
chuveiro com tubo parede

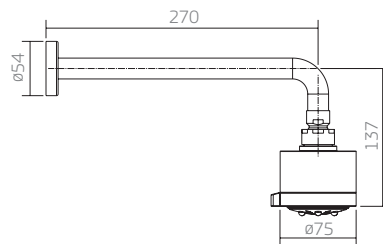
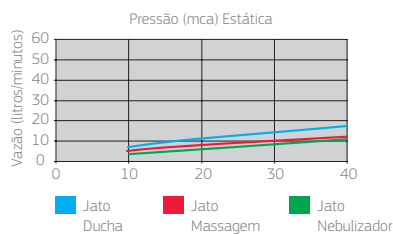

1963.C.TET
chuveiro com tubo teto

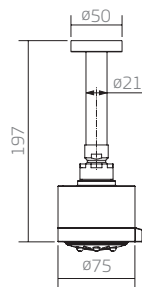
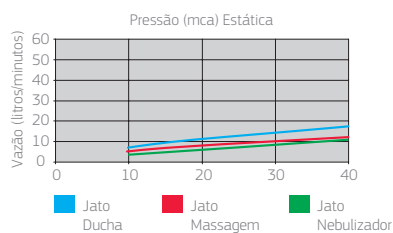

Disponível na versão cromado.

dimensões em milímetros

Pressão mínima de funcionamento 10 m.c.a para aquecedor de passagem e de acumulação.

- Funciona em alta e baixa pressão.
- Economiza água - possui baixa vazão sem perda de conforto.
- Para mudar o jato, basta girar a alavanca.

1999.C.CT
chuveiro com tubo parede

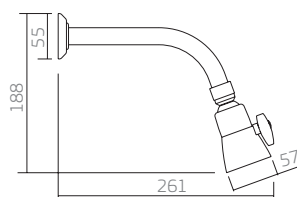
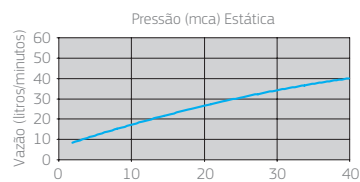

Disponível nas versões cromado, branco, bege, bege com dourado, branco com dourado e dourado.
Recomendável com pressão mínima de 4 m.c.a. para aquecedor de passagem e de 2 m.c.a. para aquecedor de acumulação.

dimensões em milímetros

1975.C
chuveiro com desviador e ducha manual

- Flexível 1,80 m.

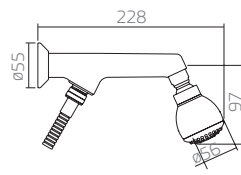
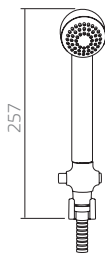
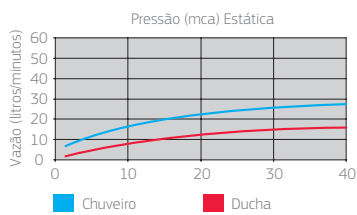

1977.C.CT
chuveiro com tubo

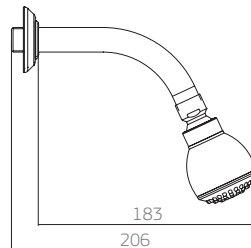
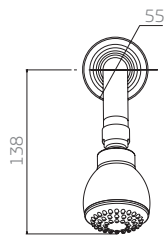
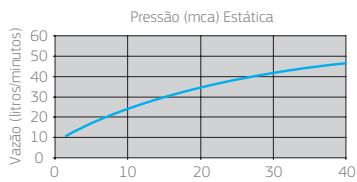

Disponível na versão cromado.

dimensões em milímetros

Recomendável com pressão mínima de 4 m.c.a para aquecedor de passagem e de 2 m.c.a. para aquecedor de acumulação.

- Jato que mistura água e ar, economiza água sem perder o conforto do banho.
- Consome apenas 6 litros de água por minuto.

1956.C.CT chuveiro com tubo parede

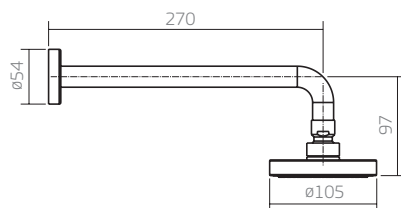
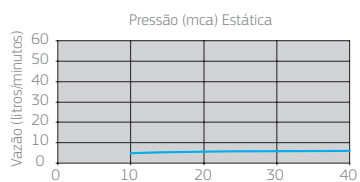

Até
70%
de economia
de água.

1956.C.TET chuveiro com tubo teto

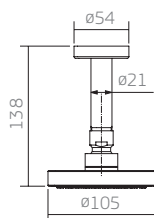
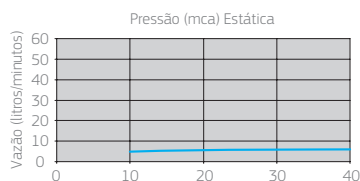

Até
70%
de economia
de água.



Disponível na versão cromado.

dimensões em milímetros

Recomendável com pressão mínima de 10 m.c.a para aquecedor de passagem e de 2 m.c.a para aquecedor de acumulação.

1970.C.CT
 chuveiro com tubo parede

- Regulagem da abertura do jato no crivo.

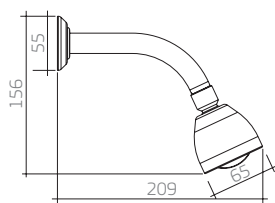
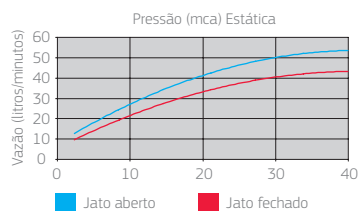

1971.C.CT
 chuveiro com tubo parede

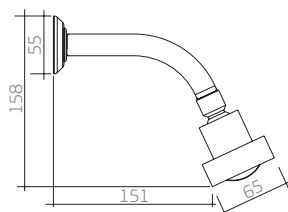
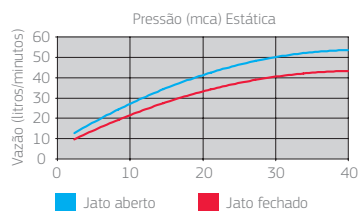

Disponível na versão cromado.

dimensões em milímetros

Recomendável com pressão mínima de 4 m.c.a. para aquecedor de passagem e de 2 m.c.a. para aquecedor de acumulação.

ASPEN

1967.C.CT chuveiro com tubo parede

- Jato forte, concentrado e uniforme
- Crivos salientes - permitem fácil limpeza

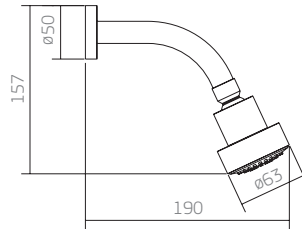
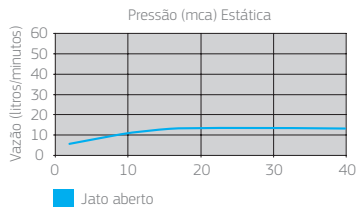

1967.C chuveiro com desviador e ducha manual

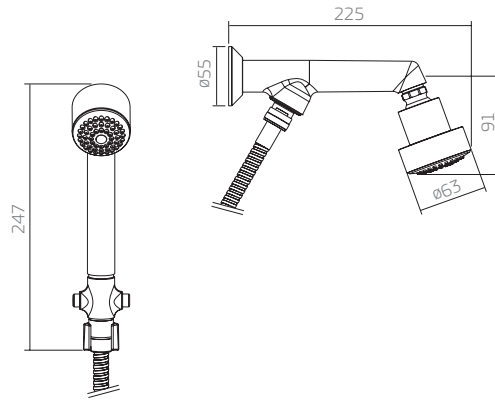
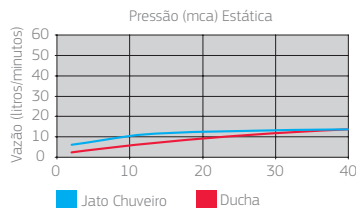

SPOT

1973.C.CT chuveiro com tubo parede

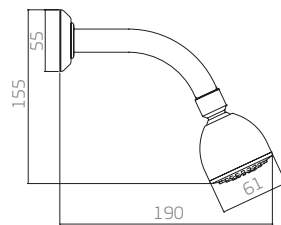
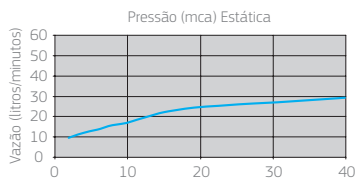

Disponível na versão cromado.

dimensões em milímetros

Recomendável com pressão mínima de 4 m.c.a. para aquecedor de passagem e de 2 m.c.a. para aquecedor de acumulação.

1988.C.QUA
 ducha lateral quadrada

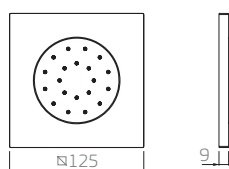

NOVO

1988.C.RED
 ducha lateral redonda

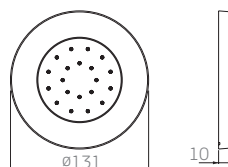

NOVO

Disponível na versão cromado.

dimensões em milímetros

- Desvia a água do chuveiro para a ducha, e da ducha para o chuveiro com um toque no botão localizado na base da ducha.

1982.C*

desviador para chuveiro

1972.C.BEP**

desviador para chuveiro com ducha manual Belle Époque

1972.C.BEL**

desviador para chuveiro com ducha manual Ducha Bell

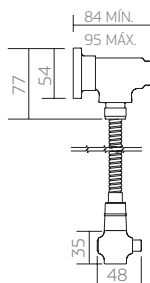

Recomendável com pressão mínima de 4 m.c.a para aquecedor de passagem e de acumulação.

1982.C.LUX.520***

desviador para chuveiro Luxo

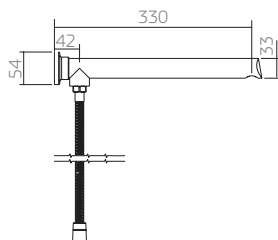

Recomendável com pressão mínima de 8 m.c.a para aquecedor de passagem e de 4 m.c.a para aquecedor de acumulação.

1982.C.LUX.330***

desviador para chuveiro Luxo

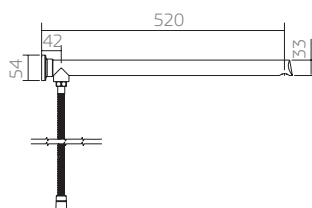

Recomendável com pressão mínima de 8 m.c.a para aquecedor de passagem e de 4 m.c.a para aquecedor de acumulação.

Aplicações para os desviadores universais luxo com tubo 33 cm e tubo 52 cm:



1990.C.ST***
chuveiro acqua plus



1997.C.ST***
chuveiro redondo



1998.C.ST***
chuveiro aquamax



1976.C.ST**
chuveiro dream

Chuveiros vendidos separadamente, para melhor conforto, recomenda-se utilizar o chuveiro 1997.C.ST com tubo 52 cm.

* Disponível nas versões cromado, branco, bege, cromado com dourado, branco com dourado, bege com dourado e dourado.

** Disponível nas versões cromado e dourado.

*** Disponível na versão cromado.

1980.C
barra deslizante Belle Époque

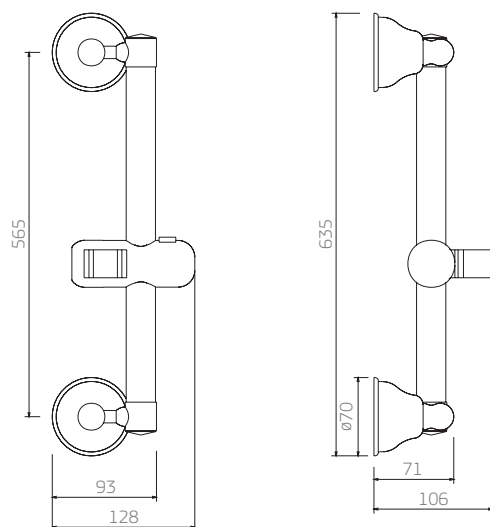

1981.C
barra deslizante Moderna

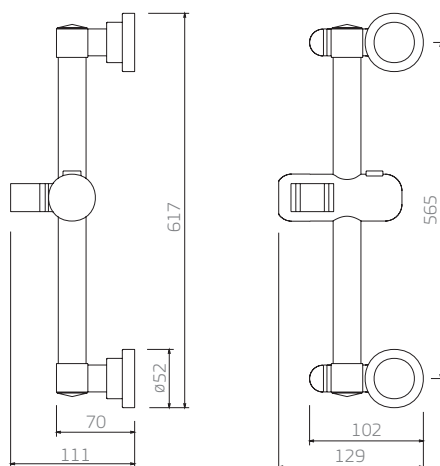

dimensões em milímetros

Este produto não acompanha a ducha.
Recomendamos utilizar o kit Flexível 4606.C.170 para a instalação da barra.
Disponível nas versões cromado e dourado.

DUCHA LATERAL

1988.C
ducha lateral parede Luxo

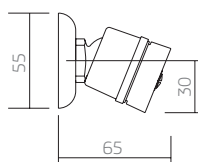

Disponível na versão cromado.

DUCHAS MANUAIS

4892.C
ducha manual Max

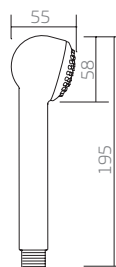
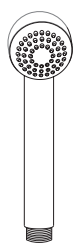
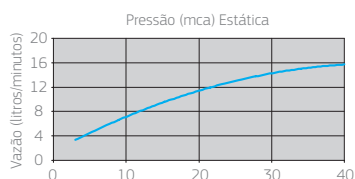

Disponível na versão cromado.

4867.C
ducha manual Aspen

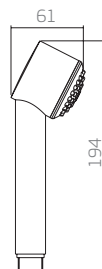
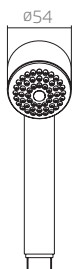

NOVO

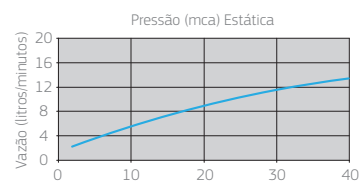

Disponível na versão cromado.

4606.C.170 - flexível avulso para ducha manual

dimensões em milímetros

4806.C
ducha manual Bell

- Auto limpante.
- Possui regulagem de jato.

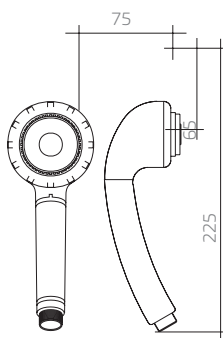
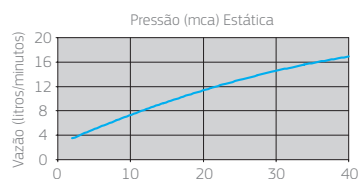

Disponível nas versões cromado e dourado.
Flexível vendido separadamente.

4894.C
ducha manual Belle Époque

- Funciona em alta e baixa pressão.

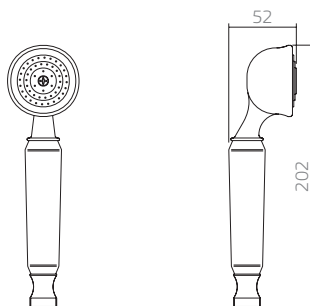
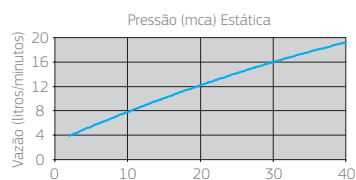

Disponível nas versões cromado e dourado.
Flexível vendido separadamente.

4606.C.170 - flexível avulso para ducha manual

dimensões em milímetros

4893.C

ducha manual Balance 5 jatos

- Pressão mínima de funcionamento 10 m.c.a.
- Cinco diferentes opções de jatos: nebulizador, massageador, ducha, combinação ducha + nebulizador e combinação ducha + massageador.

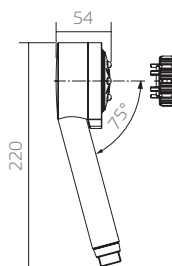
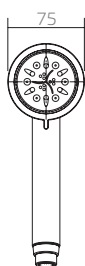
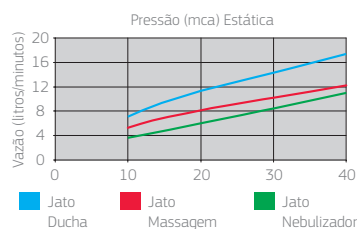

Disponível na versão cromado.

4897.C.ARE

ducha manual Balance 12 com 1 jato

- Pressão mínima de funcionamento 10 mca
- Jato que mistura água e ar, economiza água sem perder o conforto do banho

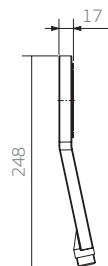
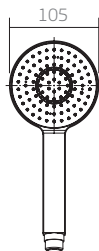
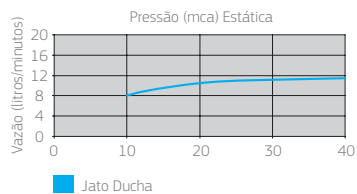

Disponível na versão cromado.

4606.C.170 - flexível avulso para ducha manual

dimensões em milímetros

- Crivos salientes facilitam a limpeza.

4898.C.ARE

ducha manual Balance 12 com 2 jatos

- Pressão mínima de funcionamento 10 m.c.a. jato que mistura água e ar,
- Economiza água sem perder o conforto do banho
- 2 opções de jato

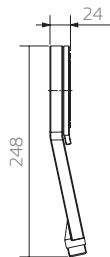
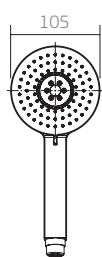
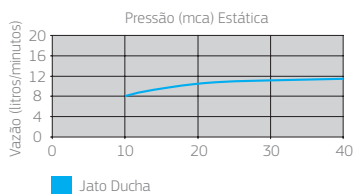

4806.C.CIL

ducha manual Cilíndrica

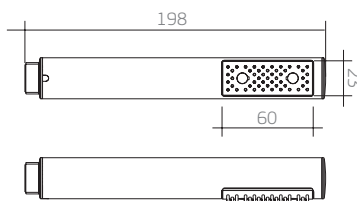
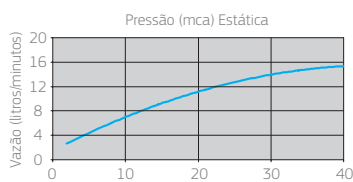

4806.C.QUA

ducha manual Quadrada

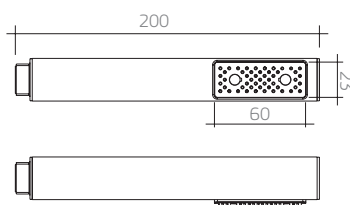
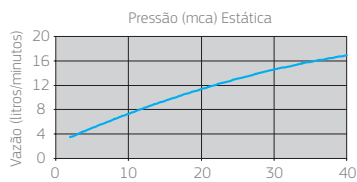

Flexível vendido separadamente.



Disponível na versão cromado.

4606.C.170 - flexível avulso para ducha manual

dimensões em milímetros



Deca

Deca

COMPLEMENTARES

SIFÕES	327
VÁLVULA DE ESCOAMENTO	331
KIT INSTALAÇÃO BACIA	333
DECANEL	334
COMPLEMENTOS	334

1680.C.114
sifão para tanque

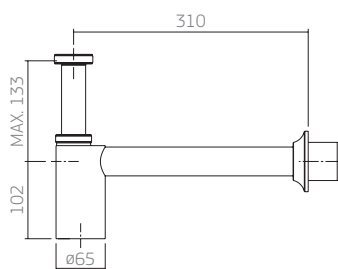

Disponível na versão cromado.

1680.C.112
sifão para cozinha/tanque

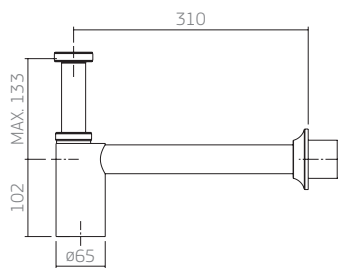
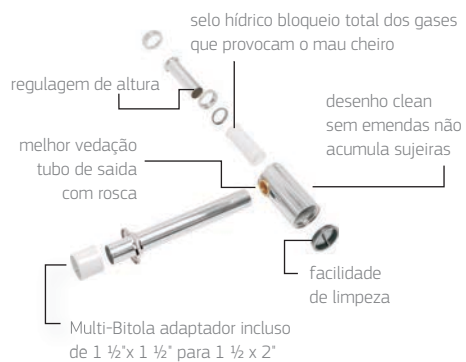

Disponível na versão cromado.

dimensões em milímetros

1680.C.100.112
sifão para lavatório

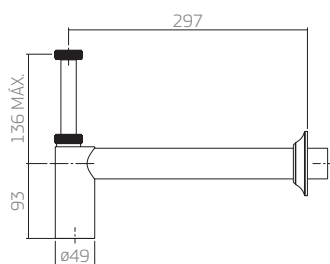

Disponível nas versões: cromado, preto fosco e dourado.

1684.C.100.112
sifão para lavatório slim

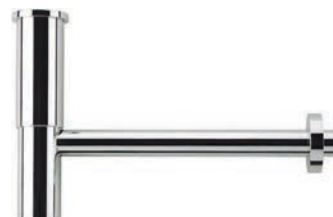
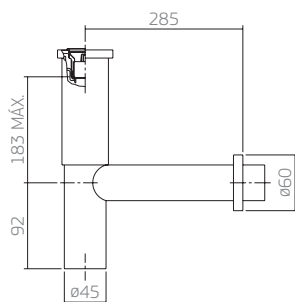

Disponível nas versões cromado, dourado e gold.

1683.C
capa sifão

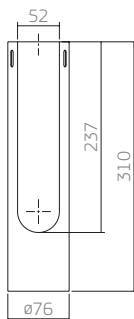

Disponível na versão cromado.

dimensões em milímetros

1685.C.100.112
sifão para lavatório

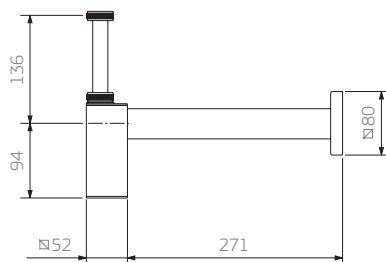

1681.C.100
sifão para mictório

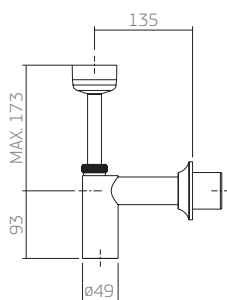

Disponível na versão cromado

dimensões em milímetros

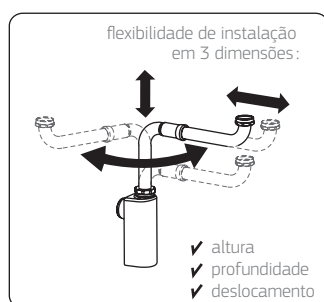
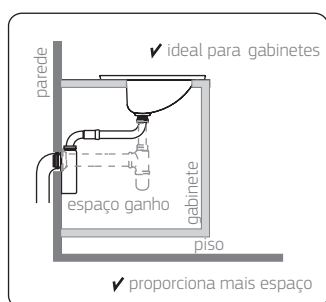

1682.C.112
sifão articulado para cozinha

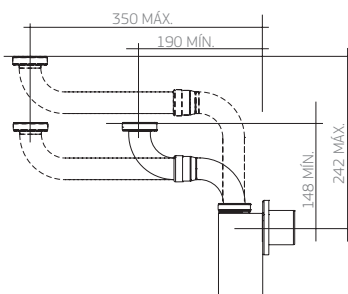

1682.C.100.112
sifão articulado para lavatório

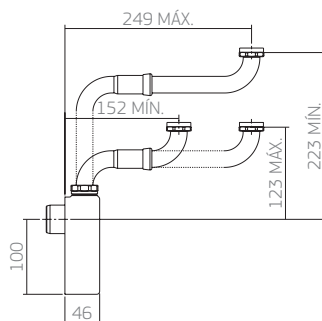

Não recomendamos para utilização com cubas com válvula oculta. Ideal para banheiros para pessoas com mobilidade restrita.

Disponível na versão cromado

dimensões em milímetros

1601.C.CLI
 válvula de escoamento click
 para lavatório, cuba e bidê

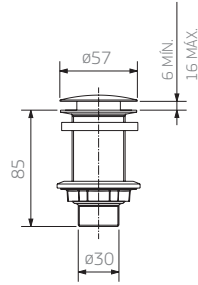

Disponível na versão cromado.

1601.C
 válvula de escoamento luxo para
 lavatório, cuba e bidê

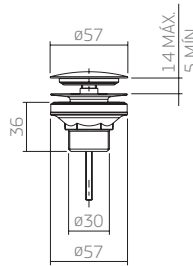

Disponível nas versões: cromado, preto fosco, dourado e gold.

1602.C
 válvula de escoamento para
 lavatório, cuba e bidê

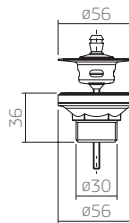

Disponível nas versões cromado e dourado.

1602.C.PLA
 válvula de escoamento para
 lavatório, cuba e bidê

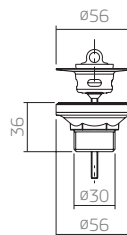

Disponível na versão cromado.

dimensões em milímetros

1606.C
válvula de escoamento para tanque sem ladrão

1605.C
válvula de escoamento para tanque sem ladrão

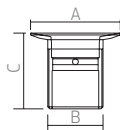

	1 ¼"	1 ½"
A	65	77
B	42	47
C	88	75



Disponível na versão cromado.

1622.C
válvula de escoamento cozinha

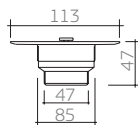

Disponível na versão cromado.

1623.C
válvula de escoamento cozinha

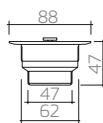

Disponível na versão cromado.

VÁLVULA DE ESCOAMENTO X SIFÃO CORRESPONDENTE

Lavatório	 1601.C.CLI	 1685.C 1" x 1 1/2"	 1682.C 1" x 1 1/2"		
	 1601.C			 1680.C 1" x 1 1/2"	 1684.C 1" x 1 1/2"
	 1602.C				
	 1602.C.PLA				
Tanque	 1605.C	 1684.C. 114 1" x 1 1/2"			
Cozinha	 1622.C	 1680.C 1 1/2" x 1 1/2" com adaptador para 1 1/2" x 2"	 1682.C.112 1" x 1 1/2"		
	 1606.C				
	 1623.C				

dimensões em milímetros



1200.C.KIT.P
 kit instalação para bacia convencional
 (fixação vertical)

Este kit contém: tubo de ligação, Decanel e parafuso de fixação SP.13.01.



1200.C.KIT.PCD
 kit instalação para bacia para caixa acoplada
 (fixação vertical)

Este kit contém: flexível, Decanel e parafuso de fixação SP.13.01.



1201.C.KIT.P
 kit instalação para bacia convencional
 (fixação lateral)

Este kit contém: tubo de ligação, Decanel e parafuso de fixação SP.121.01.



1201.C.KIT.PCD
 kit instalação para bacia para caixa acoplada
 (fixação lateral)

Este kit contém: flexível, Decanel e parafuso de fixação SP.121.01.



dimensões em milímetros

DECANEL

AV.90
DECANEL - anel de vedação com guia para bacias

- Veda o mau cheiro do esgoto e dispensa o uso de bolsa plástica.
- Anti-bacteriana.
- Não resseca.
- Não mancha o piso.



COMPLEMENTOS

1968.C.KID
tubo de ligação para
bacia infantil

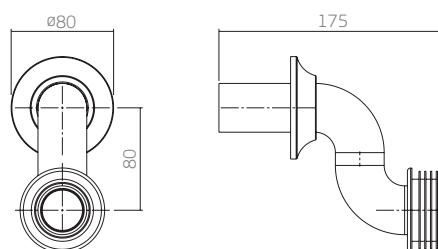

Disponível nas versões: cromado e branco.

1968.C
tubo de ligação com anel
expansor para bacia

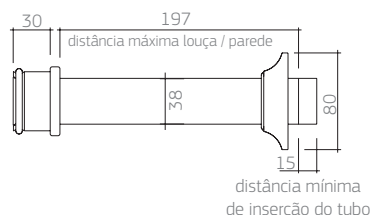

Disponível nas versões: cromado, branco, bege, dourado e gold.

4606.C
ligação flexível

Código	A
4606.C.030	300
4606.C.040	400

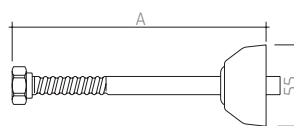

Disponível nas versões: cromado, dourado e gold.

4607.C
ligação flexível de
malha de aço inox

Código	A
4607.C.030	300
4607.C.040	400
4607.C.050	500

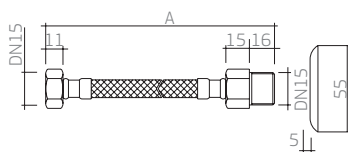

dimensões em milímetros

SP.121
conjunto de fixação lateral
para bacias



SP.7
conjunto de fixação para
lavatório e coluna



FT.11
conjunto de fixação
para tanque



1100.SP.134
opcional



SP.132
suporta para instalação de bacia
e bidê suspensos em alvenaria



1100.SP.133
suporte para instalação
para bacia em drywall

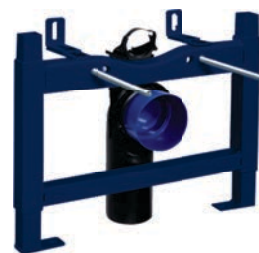

dimensões em milímetros

FM.711
conjunto de instalação para
mictório M.711



FM.712
conjunto de instalação para
mictório M.712



FM.713
conjunto de instalação para mictório
M.713 e M.715



FM.714
conjunto de instalação para
mictório M.714



FM.716
conjunto de instalação para
mictório M.716



SP.13 (cromado)
SP.130 (dourado)
conjunto de fixação para bacia e bidê



BS.5
conexão de entrada de água para
bacia convencional



CH.01
canopla para bacia com saída horizontal
P.90 / P.131 / P.133 / P.900



dimensões em milímetros



ACESSIBILIDADE E HOTEL

BARRA DE APOIO - TUBOCOLOR	341
BARRAS DE APOIO - AÇO INOX	346
SUORTE PARA FIXAÇÃO DE BARRAS DE APOIO	351
LINK CONFORTO	352
HYDRA ECO CONFORTO	353
DECAMATIC CONFORTO	354
LINHA CONFORTO	355
ACESSÓRIOS DECA HOTEL	359

- As barras de apoio tubocolor, no acabamento branco, estão em conformidade com a norma de Acessibilidade NBR 9050: 2004
- Revestimento em Nylon/PVC, garantia de uma superfície lisa, com maior aderência e proteção a choque térmico.
- Durabilidade e resistência: As barras foram desenvolvidas em aço galvanizado com 2,5mm de espessura.
- Resistentes à corrosão conforme exigido pela NBR 10283.
- Proteção antibacteriana.
- Recomendada para hospitais, lugares públicos e onde existam problemas de locomoção por parte dos usuários.

2310.E.040.BR
barra de apoio

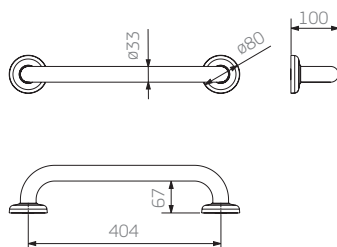

2310.E.070.BR
barra de apoio

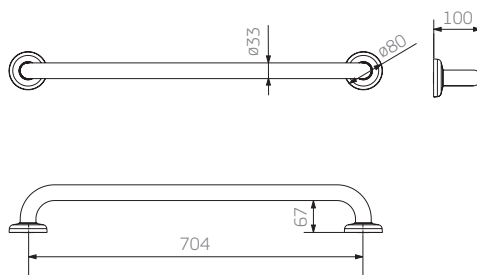

2310.E.080.BR
barra de apoio

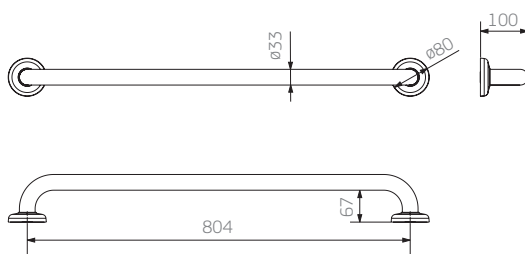

dimensões em milímetros



BARRAS DE APOIO - TUBOCOLOR

2315.E.060.BR
barra articulada

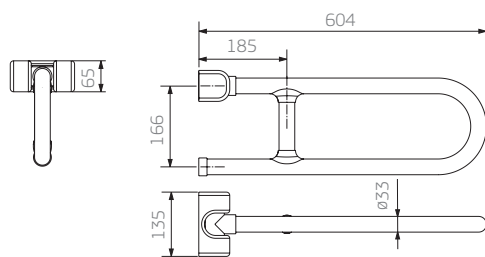

2315.E.080.BR
barra articulada

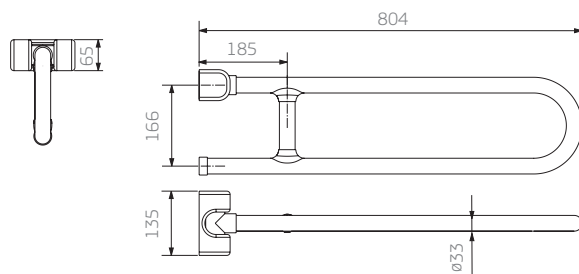

dimensões em milímetros



2335.E.BR
barra de apoio "L" esquerdo

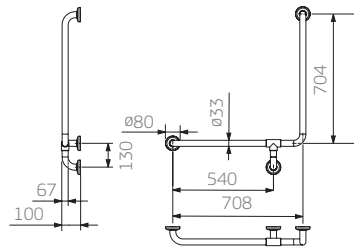

2340.E.BR
barra de apoio "L" direito

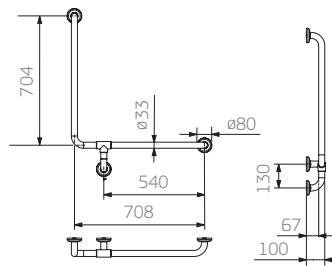

2355.E.BR
cadeira banho articulada

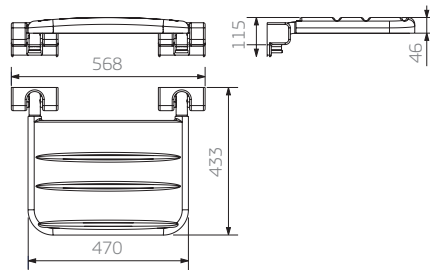

dimensões em milímetros



BARRAS DE APOIO - TUBOCOLOR

2375.E.060.BR
barra de apoio lateral

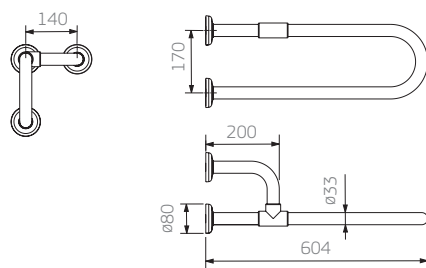

2375.E.080.BR
barra de apoio lateral

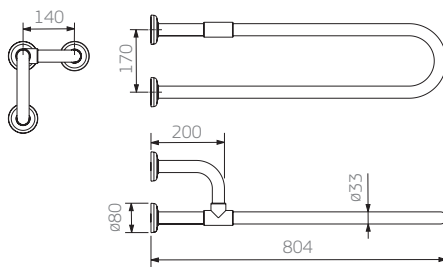

dimensões em milímetros



2380.E.BR
barra de canto para
lavatório



Ilustração de Instalação



2390.E.BR
barra para lavatório

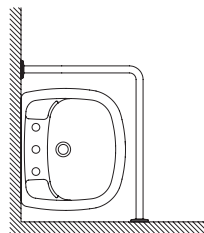
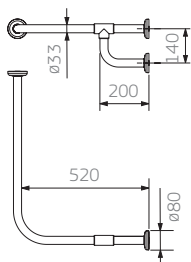
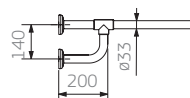
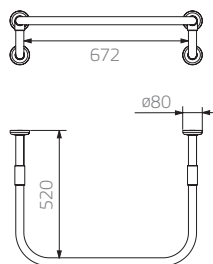

2360.E.BR
assento sanitário com
abertura frontal

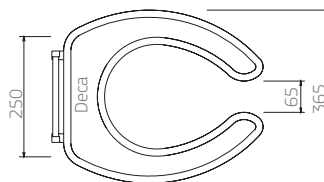
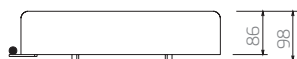

dimensões em milímetros



BARRAS DE APOIO - AÇO INOX

- Possui duas versões: Aço inox Polido e Aço inox Escovado.
- As barras de apoio aço inox, estão em conformidade com a norma de Acessibilidade NBR 9050: 2004.
- Duráveis e resistentes à corrosão conforme exigido pela NBR 10283.
- As barras foram desenvolvidas em aço inox com 1,5 mm de espessura.

2310.C.040.ESC
barra de apoio

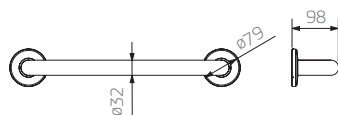

2310.C.040.POL
barra de apoio



2310.C.070.ESC
barra de apoio

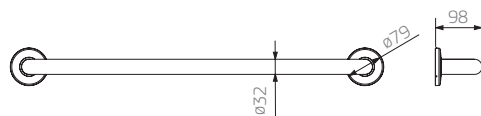

2310.C.070.POL
barra de apoio



2310.C.080.ESC
barra de apoio

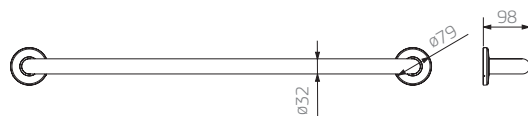

2310.C.080.POL
barra de apoio



dimensões em milímetros



2315.C.060.ESC
barra articulada

2315.C.060.POL
barra articulada

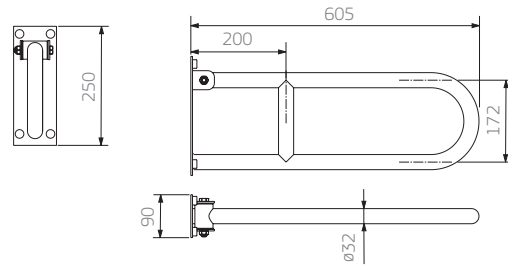

2315.C.080.ESC
barra articulada

2315.C.080.POL
barra articulada

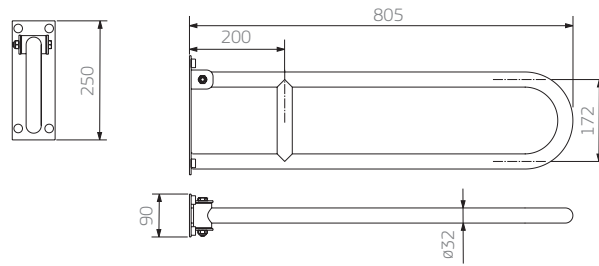

2335.C.ESC
barra de apoio "L"

2335.C.POL
barra de apoio "L"

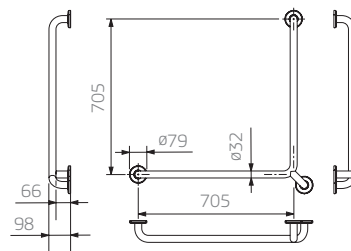

dimensões em milímetros



BARRAS DE APOIO - AÇO INOX

2370.C.060.ESC
barra de apoio lateral
esquerda

2370.C.060.POL
barra de apoio lateral
esquerda

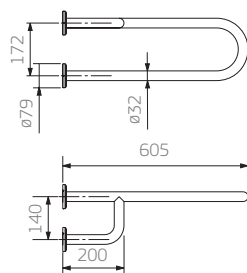

2370.C.080.ESC
barra de apoio lateral
esquerda

2370.C.080.POL
barra de apoio lateral
esquerda

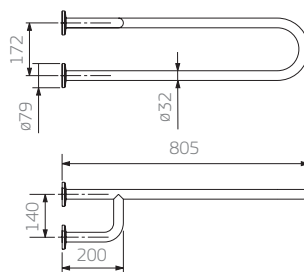

dimensões em milímetros

2375.C.060.ESC
barra de apoio lateral
direita

2375.C.060.POL
barra de apoio lateral
direita

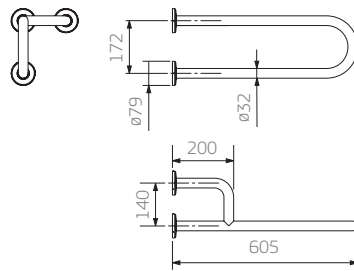

2375.C.080.ESC
barra de apoio lateral
direita

2375.C.080.ESC
barra de apoio lateral
direita

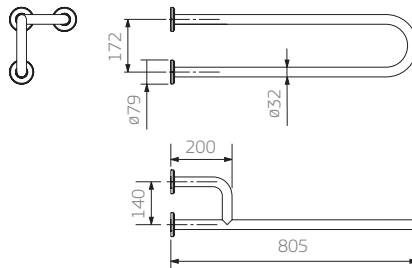

2380.C.ESC
barra de canto
esquerda para
lavatório

2380.C.POL
barra de canto
esquerda para
lavatório



Ilustração de Instalação



dimensões em milímetros

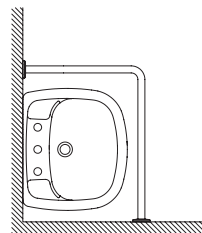
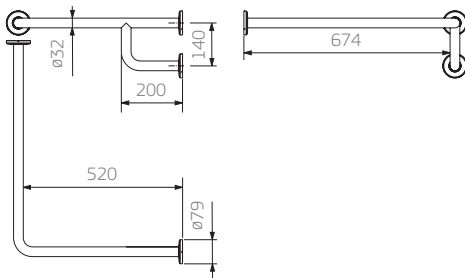

BARRAS DE APOIO - AÇO INOX

2385.C.ESC
barra de canto
direita para
lavatório

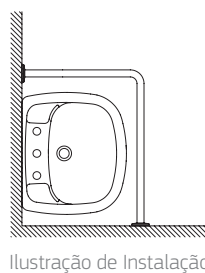
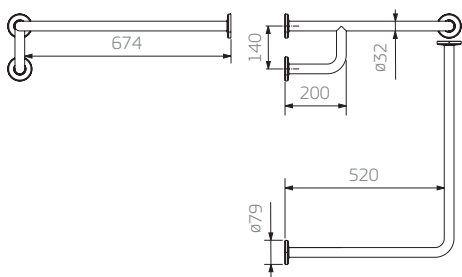

2385.C.POL
barra de canto
direita para
lavatório

2390.C.ESC
barra para lavatório

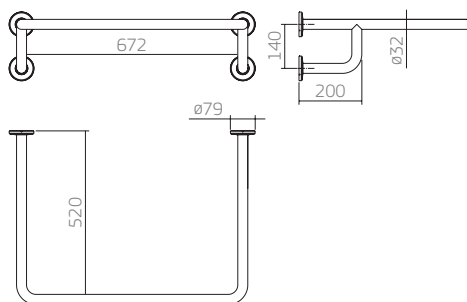

2390.C.POL
barra para lavatório

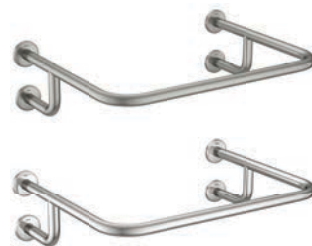

dimensões em milímetros

- Estrutura metálica galvanizada resistente a corrosão.
- Painel de madeira reforçada e resistente a umidade.
- Indicada para fixação de barras de apoio.

1100.SP.136.01
suporte para barras de apoio para
instalação em drywall

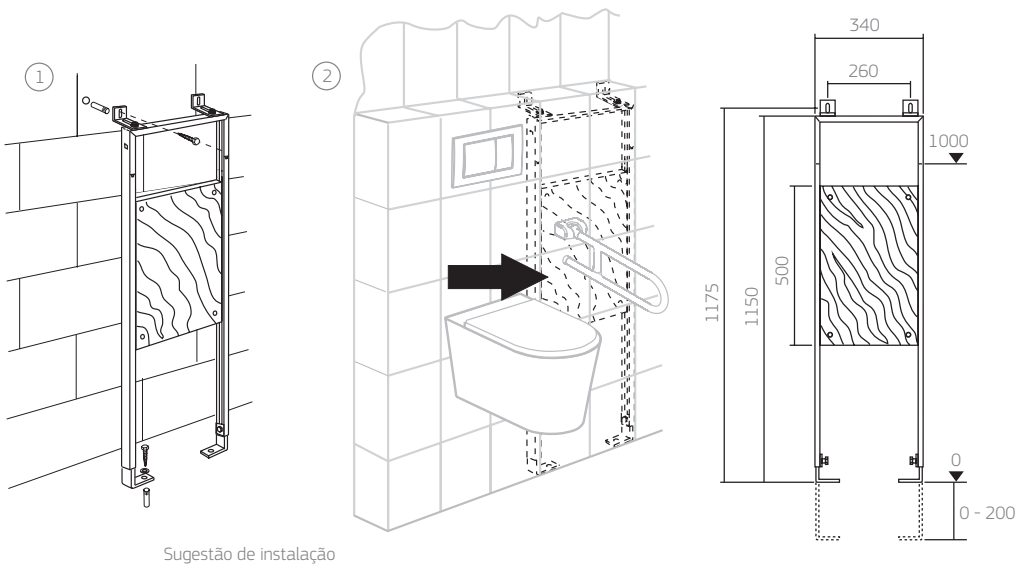

dimensões em milímetros



1196.C.LNK
torneira lavatório mesa

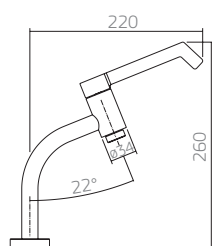
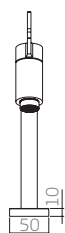

1176.C.LNK
torneira lavatório parede

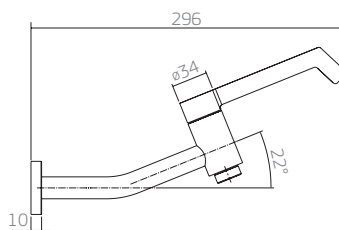
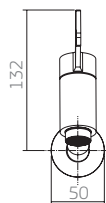

dimensões em milímetros



NOVO

- Qualidade reconhecida.
- Alavanca que facilita e suaviza o acionamento.
- Com tecnologia exclusiva: Economiza água através de restritor de fluxo - independente do tempo de pressão a válvula limita o fluxo em 6 litros.
- Recomendável utilização com bacias de 6 litros.
- Disponível em duas bitolas: 1 1/2" e 1 1/4"
- Pode ser instalada em alta ou baixa pressão.
- Fácil manutenção.
- Canopla com sistema anti vandalismo.
- Ideal para utilização por pessoas portadoras de necessidades especiais e em locais públicos.
- Disponível na versão cromado.



ALTA PRESSÃO	BAIXA PRESSÃO
DN 32 (1 ¼)	DN 40 (1 ½)
100 a 400 Kpa	20 a 100 Kpa
1,0 a 4,0 Kgf/cm ²	0,2 a 1,0 Kgf/cm ²

Cromado

2565.C.114.CONF
válvula de descarga
Hydra Eco Conforto

2565.C.112.CONF
válvula de descarga
Hydra Eco Conforto

4900.C.CONF
acabamento
Hydra Eco Conforto

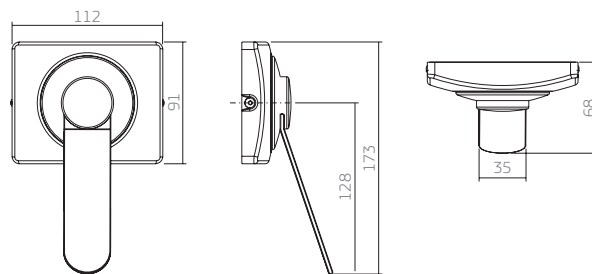

dimensões em milímetros



NOVO

1173.C.CONF
Torneira lavatório mesa
fechamento automático
com alavanca

Possui restritor de vazão constante 8l/m.

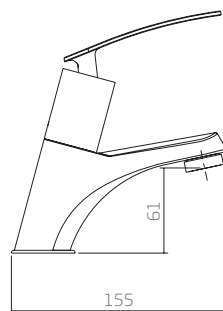
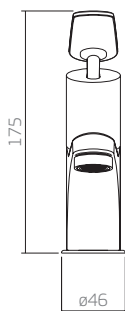

Disponível na versão cromado.

dimensões em milímetros

P.510
bacia vogue plus conforto sem abertura frontal

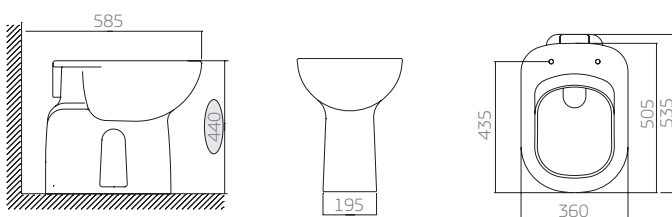

P.51
bacia vogue plus conforto
com abertura frontal

AP.52
assento com abertura
frontal

AP.521
assento com abertura
frontal sem tampa

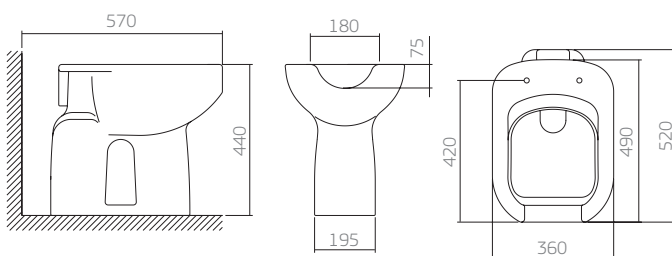

Recomendada para usuários que necessitem de auxílio em sua higienização.
Utilizar com assento AP.52 ou AP.521.

dimensões em milímetros



L.51
(lavatório)

CS.1
(coluna suspensa)
lavatório com
coluna suspensa

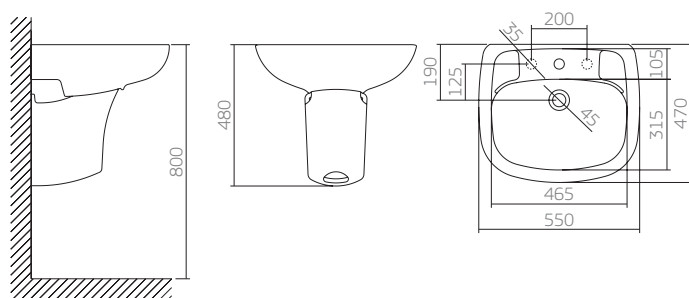

L.510
(lavatório)

C.510
(coluna suspensa)
lavatório pequeno com coluna suspensa

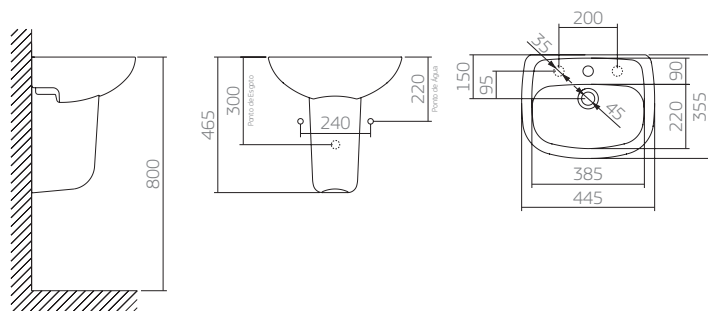

dimensões em milímetros



Medidas para Instalação

- Barras de apoio e barra de apoio lateral nas paredes para uso conjunto com bacias ou assentos sanitários com abertura frontal.

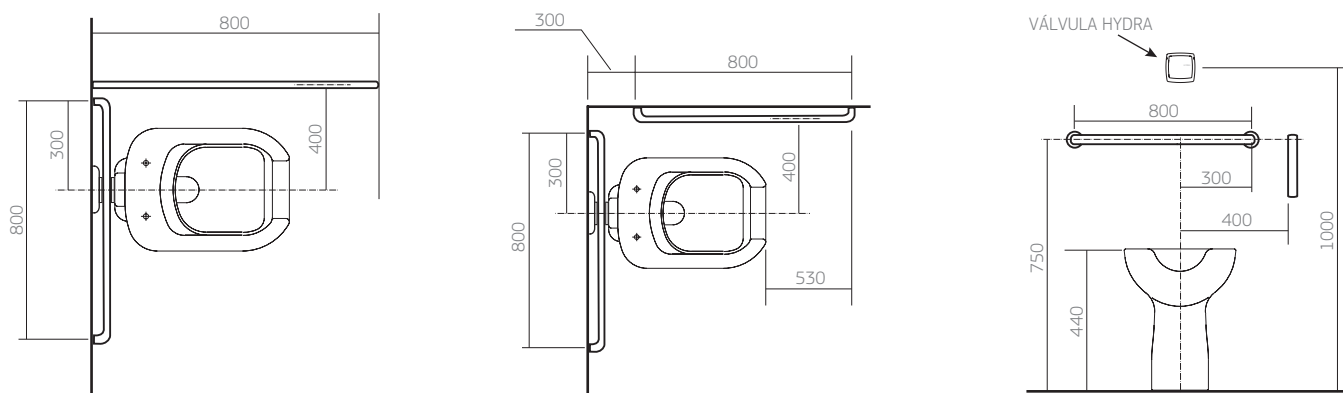

- A bacia P51 com abertura frontal, facilita a higienização íntima de pessoas com restrição de movimentos.
- Os lavatórios com coluna suspensa são adequados para o acesso à cadeirantes.

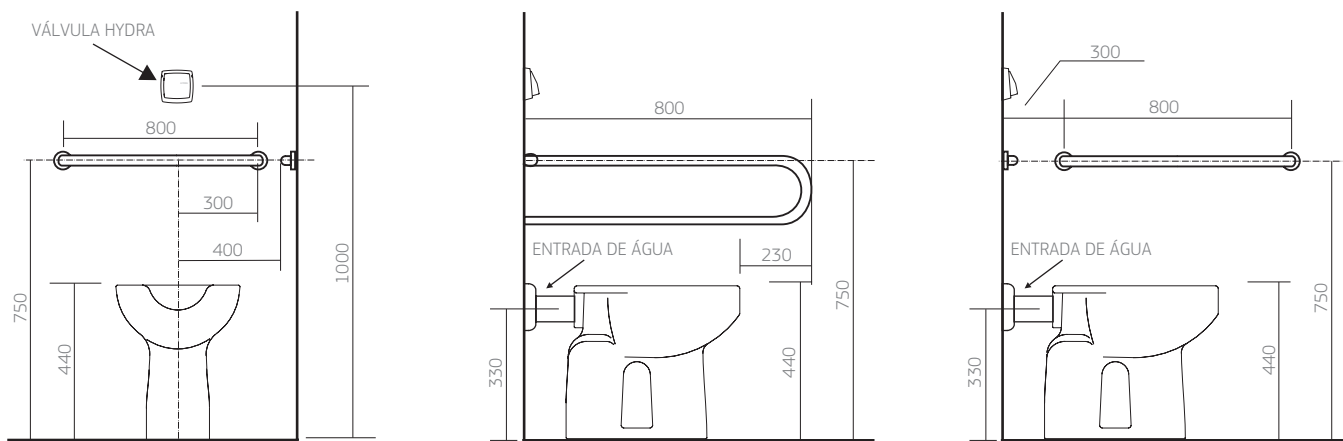

Medidas de acordo com a ABNT NBR 9050 / 2004.

dimensões em milímetros

Medidas para Instalação

Lavatórios de semi-encaixe e lavatórios com coluna suspensa.

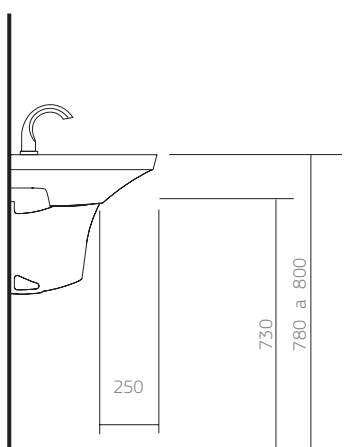

Barras de apoio para uso conjunto com mictórios.

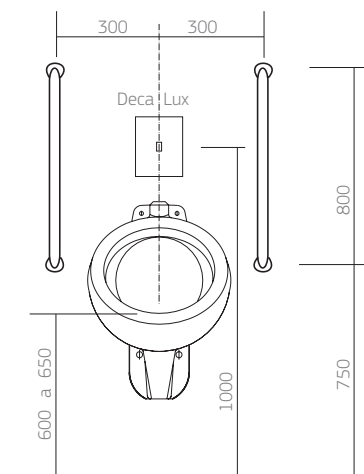

Barras de apoio, altura dos assentos removíveis, registros e duchas no box.

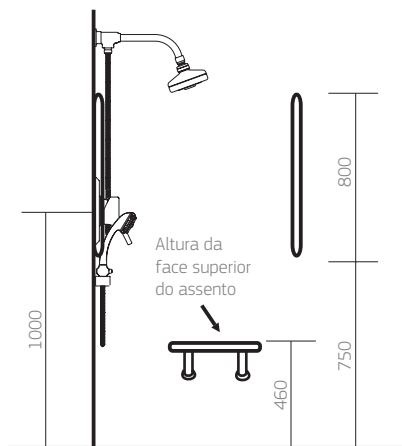

Medidas de acordo com a ABNT NBR 9050 / 2004.

ABNT NBR 9050: Acessibilidade e edificações, mobiliários, espaços e equipamentos urbanos. Esta norma estabelece critérios e parâmetros técnicos a serem observados quando do projeto, construção, instalação e adaptação de edificações, mobiliários, espaços e equipamentos urbanos às condições de acessibilidade.

ABNT NBR 10283: Revestimentos eletrolíticos de metais e plásticos sanitários. Esta norma especifica os requisitos exigíveis dos revestimentos eletrolíticos (níquel e cromo para metais sanitários e cobre; níquel e cromo para plásticos sanitários) das superfícies aparentes de metais e plásticos sanitários, utilizado nas instalações hidráulicas predial.

UNE-EN 12182: Esta norma Européia especifica os requisitos técnicos e métodos de ensaio de produtos sanitários, para pessoas com necessidades especiais.

2071.C
saboneteira

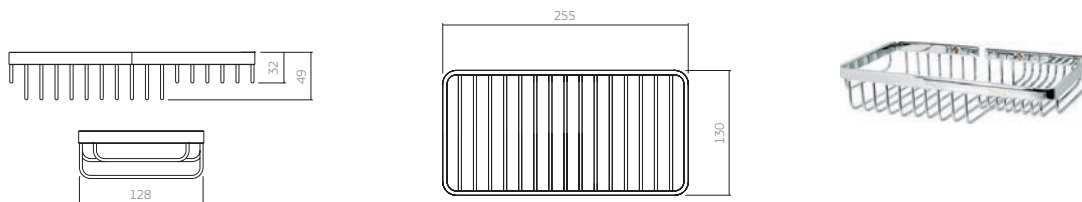

2072.C
saboneteira triangular de canto

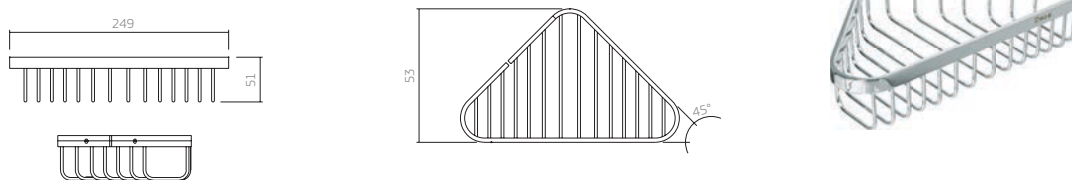

2073.C
toalheiro com barra

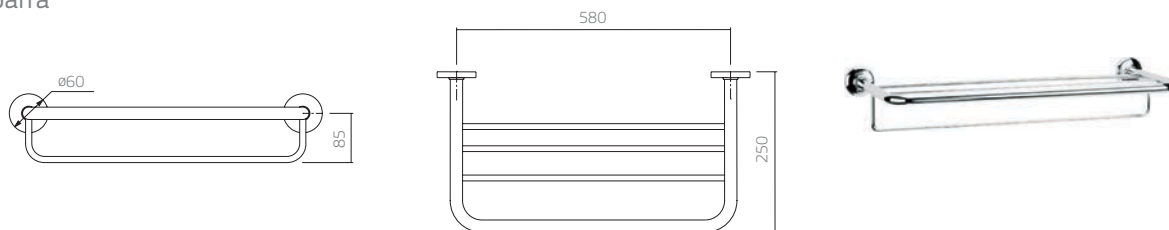

2074.C
varal retrátil

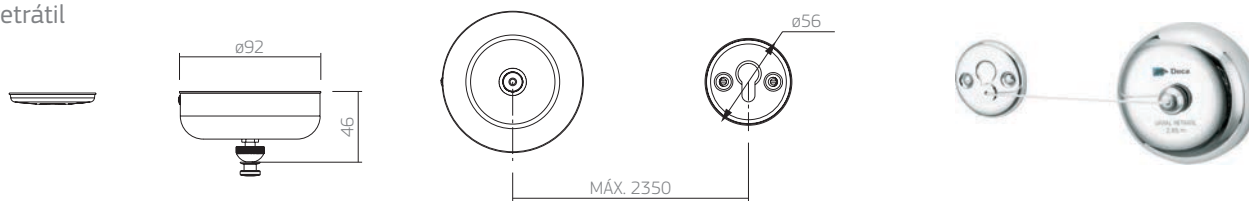

Disponível na versão cromado

dimensões em milímetros

- Design neutro, harmonizando com qualquer linha de metal. O espelho possui duas faces (imagem normal e aumentada) e adapta-se a qualquer posição, podendo ser usado como espelho auxiliar ao lado de um fixo ou mesmo como espelho único.
- O varal retrátil é excelente para flats, hotéis ou áreas de serviço pequenas.
- A alça de apoio é ideal para a área de banho, onde o risco de acidentes é maior.
- As saboneteiras tem cantos arredondados e são vazadas, proporcionando higiene e segurança.
- Fácil limpeza.
- Alça de apoio suporta cargas até 60 kg.
- Alta durabilidade:
- A resistência do acabamento da Coleção Deca Hotel é verificada por testes de confiabilidade, testes de corrosão e abrasão.

2075.C
espelho duas faces

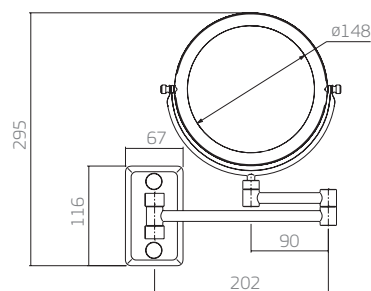

Reflexo do espelho normal e aumentado em 5 vezes

2076.C
porta lenços de papel

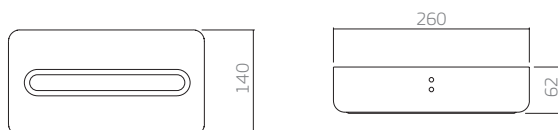

2077.C
alça de apoio

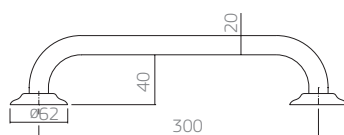

Disponível na versão cromado

dimensões em milímetros



Deca

PRODUTOS ECONOMIZADORES

DECALUX SAVE	365
DECALUX	366
DECALUX MICTÓRIO	369
TORNEIRA DECALUX DE EMBUTIR	371
DECALUX MICTÓRIO DE EMBUTIR	372
DECALUX BATERIA	373
DECALUX BATERIA MICTÓRIO	374
DECAMATIC MICTÓRIO	375
DECAMATIC	376
DECAMATIC CONFORTO	379
DECAMATIC KIDS	379
DECAMATIC ECO	380
MONOCOMANDO VOGUE PLUS	383
MONOCOMANDO SMART	384
MISTURADOR TERMOSTATO	385
MICTÓRIO SAVE	387
RESTRITORES E AREJADORES	389



- A torneira eletrônica com hidrogerador possui um **sistema inovador**, capaz de armazenar a **energia gerada pela própria força da água**, necessária para o acionamento.
- **Não é necessário ligar na rede elétrica** e não depende exclusivamente da energia de pilhas para seu funcionamento (a pilha é apenas utilizada como energia de back-up).
- Possui 2 versões com sensor e ON/OFF.
- Permite regulação da distância para acionamento.
- Arejador embutido de vazão constante.
- Versão ON/OFF possui desligamento automático após 60 segundos de uso.
- Versão com sensor possui desligamento automático após 30 segundos de uso em caso de sensor obstruído.

1187.C.HG
torneira lavatório mesa
com hidrogerador

Possui arejador de vazão constante 8 l/min

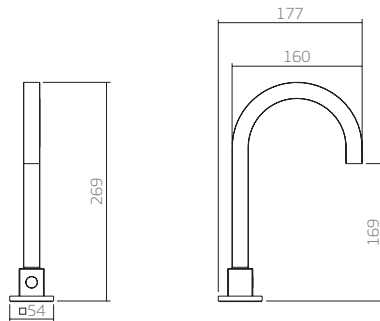

Até
70%
de economia
de água.

1188.C.HG
torneira lavatório mesa
com hidrogerador

Possui arejador de vazão constante 8 l/min

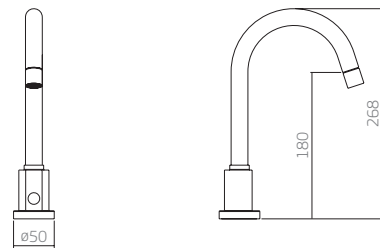

Até
70%
de economia
de água.



Disponível na versão cromada.

dimensões em milímetros

NOVO

1187.C.HG.ONOF
torneira lavatório mesa com
hidrogerador e sistema ON/OFF

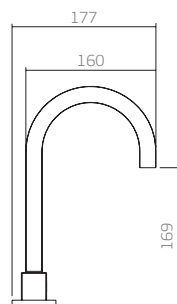
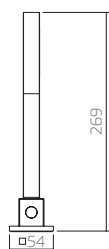

Até
70%
de economia
de água.

Possui arejador de vazão constante 8 l/min

1188.C.HG.ONOF
torneira lavatório mesa com
hidrogerador e sistema ON/OFF

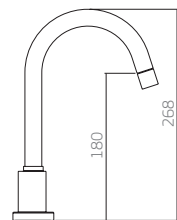
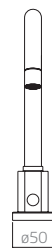

Até
70%
de economia
de água.

Possui arejador de vazão constante 8 l/min

Disponível na versão cromada.

dimensões em milímetros



- Economia de até 85% de água.
- Higiene total.
- Fechamento automático se o sensor for obstruído.
- Não dá choque: possui sistema de segurança que trabalha com baixa tensão - 12 V CC e dupla proteção elétrica.
- Arejador anti-furto.
- Disponível na versão cromado.
- Baixo consumo de energia.
- O alcance do sensor óptico na torneira é regulável.

CUIDADOS NA INSTALAÇÃO

Certifique-se de que o ponto de energia não esteja a mais de 60 centímetros de distância da torneira. No caso de cuba de sobrepor, esta não deve ultrapassar 4mm da superfície de instalação para não interferir no funcionamento do sensor.

DADOS TÉCNICOS	
Tensão de alimentação	Bivolt automática (110/220) VAC
Consumo de energia	Torneira fechada - 0,7w Torneira aberta - 6,8W
Entrada de água	DN 15 (1/2)
Alcance do sensor	100 a 300mm
Sistema anti-vandalismo (tempo máximo de funcionamento ininterrupto)	30 a 40 segundos
Pressão de sentido	2 a 40 mca

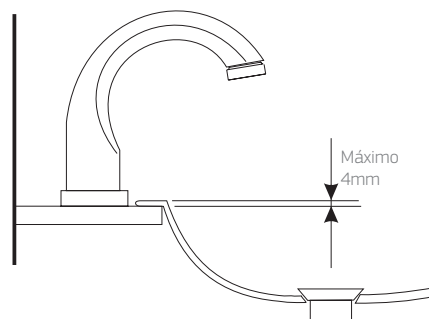

*Para um melhor desempenho de 2 a 10 m.c.a, substitua o arejador pelo de baixa pressão (acompanha o produto).

dimensões em milímetros

1180.C
torneira lavatório mesa
acionamento com sensor bivolt

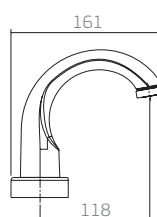
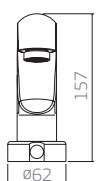

Possui arejador de vazão constante 6 l/min

1188.C
torneira lavatório mesa
acionamento com sensor bivolt

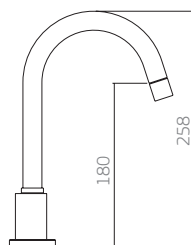

Possui arejador de vazão constante 8 l/min

1180.C.SLX
torneira lavatório mesa
acionamento com sensor bivolt

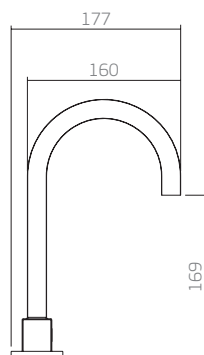
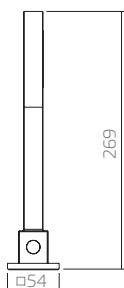

Possui arejador de vazão constante 8 l/m.



Disponível na versão cromada.
Utilizar a furação no tampo de 35mm para misturadores e torneiras de mesa.

dimensões em milímetros

- Acionamento após a saída do usuário.
- Higiene total.
- Baixo consumo de energia.
- Funciona em Alta e Baixa pressão (2 a 40 mca).
- Possui abertura e fechamento automático ideal para uso público.
- O alcance do sensor óptico e o tempo de descarga no mictório são reguláveis.
- Possui sistema de segurança que trabalha com baixa tensão - 12 V CC e dupla proteção elétrica.
- Disponível na cor Branca.
- Restritor de vazão constante 8 litros/min. incorporado para maior economia*.

DICAS DE INSTALAÇÃO

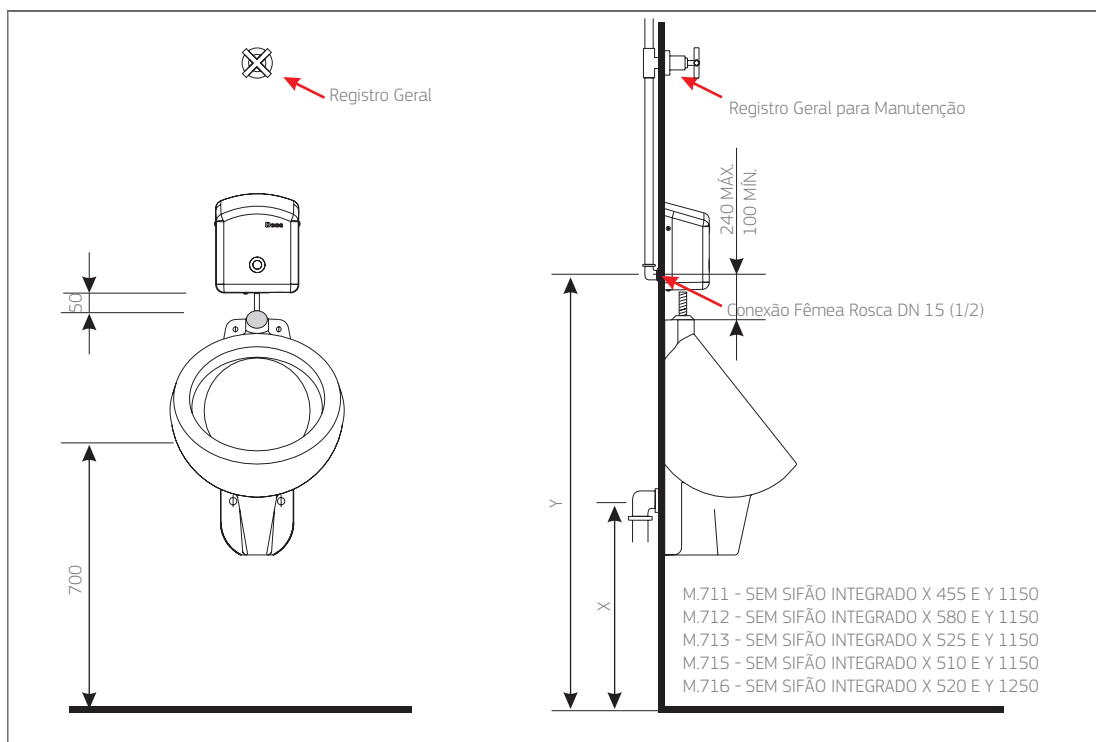

*Para um melhor desempenho de 2 a 10 m.c.a, substitua o arejador pelo de baixa pressão (acompanha o produto).

2580.E.BR
 válvula para mictório
 acionamento com sensor bivolt

DADOS TÉCNICOS	
Tensão de alimentação	Bivolt automática (110/220) VAC
Consumo de energia	Mictório fechado - 0,7w Mictório aberto - 6,8w
Entrada de água	DN 15 (1/2)
Alcance do sensor	300 a 700mm
Pressão de serviço	2 a 40mca

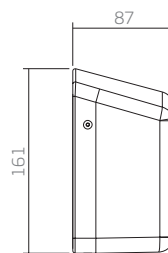
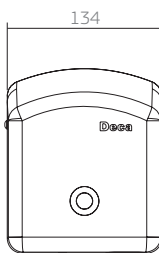

Para um melhor desempenho, retire o restritor de vazão para pressões de 2 a 10 m.c.a.

dimensões em milímetros

- Não dá choque: possui sistema de segurança que trabalha com baixa tensão - 12 V CC e dupla proteção elétrica.
- Higiene total.
- Fechamento automático se o sensor for obstruído.
- Arejador anti-furto.
- Baixo consumo de energia quando em uso.
- O alcance do sensor óptico na torneira é regulável.
- Sistema anti-vandalismo.
- Acompanha arejador de vazão constante 8 l/min*.
- Ideal para ser instalado com lavabo cirúrgico.

1780.C
torneira lavatório embutida
parede acionamento com sensor

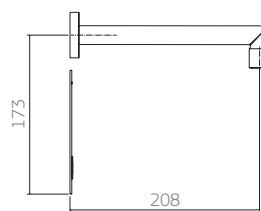
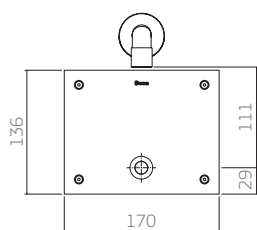

CUIDADOS NA INSTALAÇÃO

O produto requer instalações elétricas e hidráulicas embutidas.

DADOS TÉCNICOS	
Tensão de alimentação	Bivolt automática (110/220) VAC
Consumo de energia	Torneira fechada - 0,7w Torneira aberta - 6,8w
Entrada de água	DN 15 (1/2)
Alcance do sensor	100 a 300mm
Sistema anti-vandalismo (tempo máximo de funcionamento ininterrupto)	30 a 40 segundos
Pressão de serviço	2 a 40mca.



* Para um melhor desempenho de 2 a 10 mca, substitua o arejador pelo de baixa pressão (acompanha o produto). Disponível nas versões cromado e aço inox.

dimensões em milímetros

- Acionamento após a saída do usuário.
- Higiene total.
- Baixo consumo de energia quando em uso.
- Funciona em Alta e Baixa pressão (2 a 40 mca).
- Possui abertura e fechamento automático ideal para uso público.
- O alcance do sensor óptico e o tempo de descarga no mictório são reguláveis.
- Possui sistema de segurança que trabalha com baixa tensão - 12 V CC e dupla proteção elétrica.
- Restritor de vazão constante 8 litros/min. incorporado para maior economia*.

2780.C**
válvula para mictório acionamento
com sensor - embutida

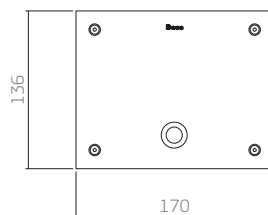

CUIDADOS NA INSTALAÇÃO

O produto requer instalações elétricas e hidráulicas embutidas.

DADOS TÉCNICOS	
Tensão de alimentação	Bivolt automática (110/220) VAC
Consumo de energia	Mictório fechado - 0,7w Mictório aberto - 6,8w
Entrada de água	DN 15 (1/2)
Alcance do sensor	400 a 700mm
Pressão de serviço	2 a 40mca



* Para um melhor desempenho de 2 a 10 m.c.a, substitua o arejador pelo de baixa pressão (acompanha o produto).
** Somente para mictório.
Disponível nas versões cromado e aço inox.
Ideal para uso com mictório Deca M.714

dimensões em milímetros

1183.C
torneira lavatório mesa acionamento
com sensor a bateria

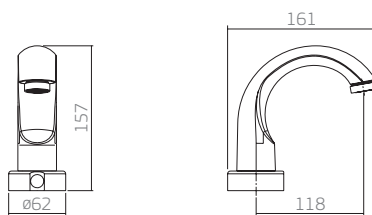

Possui arejador de vazão constante 6 l/min

1183.C.SLX
torneira lavatório mesa acionamento
com sensor a bateria

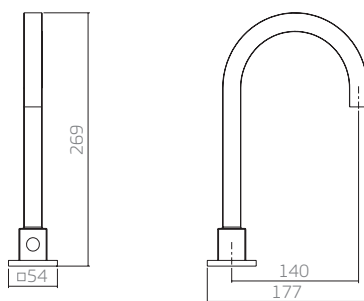

Possui arejador de vazão constante 8 l/min



Utilizar a furação no tampo de 35mm para misturadores e torneiras de mesa.

dimensões em milímetros

- Acionamento após a saída do usuário.
- Higiene total.
- Consumo de água por descarga regulável.
- Funciona em Alta e Baixa pressão (2 a 40 mca).
- Possui abertura e fechamento automático ideal para uso público.
- O alcance do sensor óptico e o tempo de descarga no mictório são reguláveis.
- Trabalha com 4 pilhas alcalinas tipo AA.
- Possui regulador de vazão incorporado à solenoide.
- Possui LED indicador de bateria fraca.
- Equipada com dispositivo economizador de bateria (patente Deca).
- Disponível na cor Branca.
- Possui restritor de vazão constante de 8 l/min.

DICAS DE INSTALAÇÃO

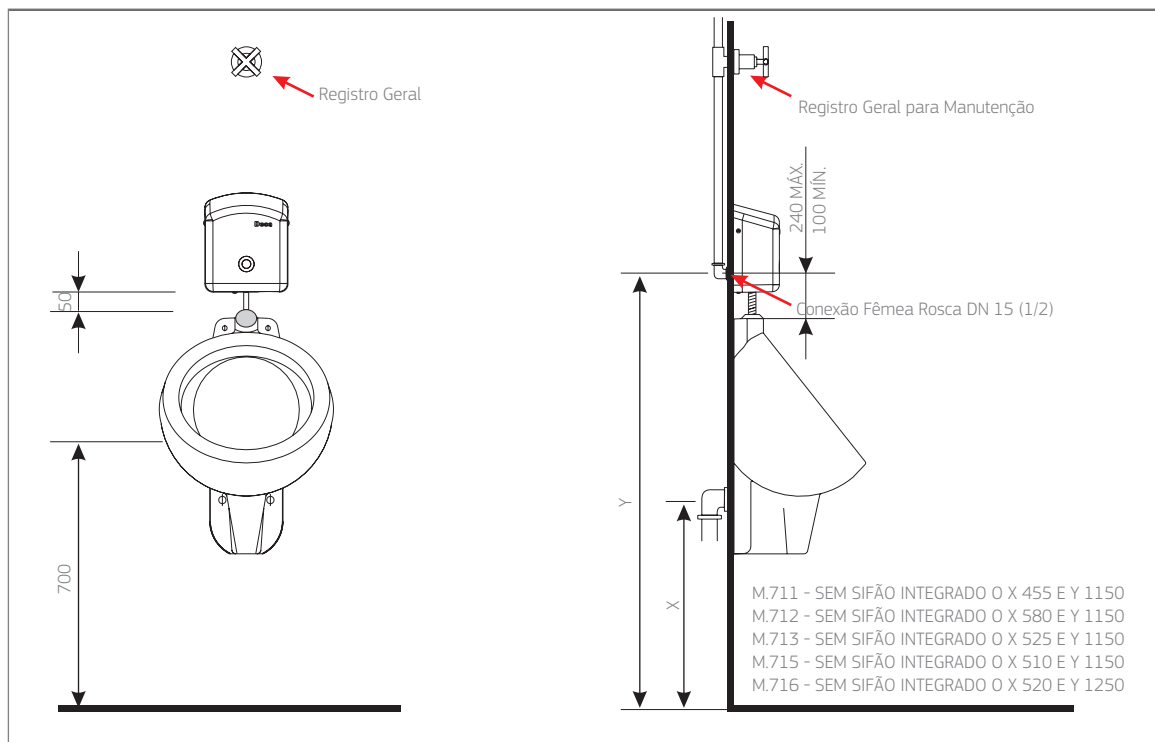

dimensões em milímetros

2583.E.BR
 válvula para mictório acionamento com
 sensor de bateria

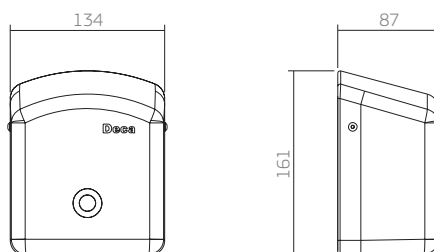

DADOS TÉCNICOS	
Alimentação	4 pilhas alcalinas tipo AA
Durabilidade	300.000 ciclos
Entrada de água	DN 15 (1/2)"
Sensibilidade do range	300 a 700mm
Pressão de serviço	2 a 40 m.c.a

2570.C
 válvula mictório
 fechamento automático

- Atende à norma da ABNT NBR 13713
- É a única que permite regulagem de vazão através do Registro Integrado
- Possui botão anti-furto
- Disponível na versão cromado

DADOS TÉCNICAS	
Entrada de água	DN 15 (1/2)"
Tempo médio de fechamento	4 a 10 segundos
Pressão de serviço	2 a 40 m.c.a

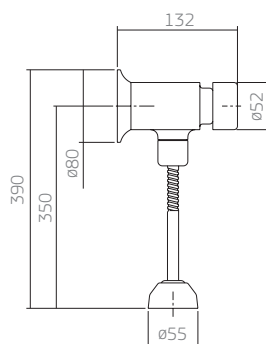

dimensões em milímetros



- Atende à norma da ABNT NBR 13713.
- Permite economia de até 70% no consumo de água.
- Possui botão e arejador anti-furto.
- Disponível na versão cromado.

1170.C
torneira lavatório mesa
fechamento automático

tempo de fechamento
de 4 a 10 segundos

DADOS TÉCNICOS	
Entrada de água	DN 15 (1/2)"
Pressão de serviço	2 a 40mca

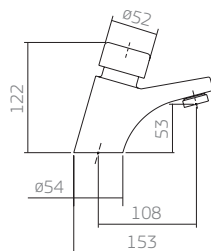

Permite regulação de vazão através do Registro Integrado.

1172.C.LNK
torneira lavatório mesa
fechamento automático

tempo de fechamento
de 4 a 10 segundos

DADOS TÉCNICOS	
Entrada de água	DN 15 (1/2)"
Pressão de serviço	2 a 40 m.c.a

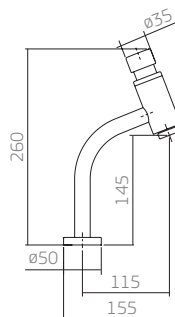

Possui restritor de vazão constante de 8 l/min..

dimensões em milímetros



- Produto desenvolvido para instalação em tampos, indicando para todas cubas de sobrepor e embutir, desde que não possuam deck.
- Possui botão antivandalismo.
- Reservatório de sabão antifurto.
- Capacidade do reservatório 1 litro, para aproximadamente 1000 acionamentos, ou seja, 1 ml/acionamento.
- Maior durabilidade - utilização para diferentes viscosidades de sabão.
- Dimensões apropriadas para maior conforto do usuário.
- Fechamento automático com sistema de retenção de líquido após utilização, evitando vazamentos.
- Atende a norma ABNT NBR 13713.

2015.C
porta sabão líquido

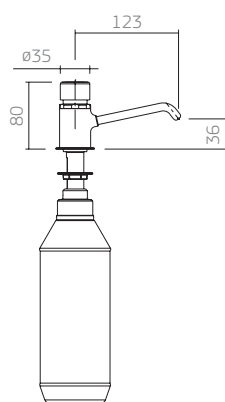
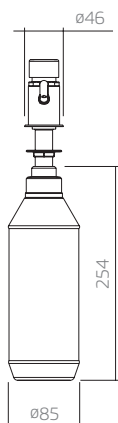

Utilizar a furação no tampo de 35mm para misturadores e torneiras de mesa.
Disponíveis na versão cromado.

dimensões em milímetros

- Possui registro de vazão embutido, permitindo aumentar a economia e o conforto.
- Fechamento automático.
- Tempo médio de funcionamento de 35 a 45 segundos.
- Acionamento suave.
- Totalmente antivandalismo, pois é embutido na parede.
- Possui acabamento e botão antifurto.
- Recomendamos sua utilização com água fria ou pré-misturada.
- Atende a norma ABNT NBR 13713.

2670.C
válvula para chuveiro Decamatic
com fechamento automático

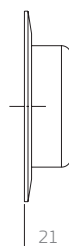
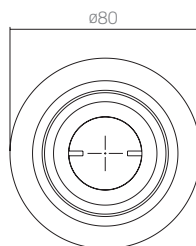

Até
60%
de economia
de água.



dimensões em milímetros

1173.C.CONF
Torneira lavatório mesa
fechamento automático
com alavanca

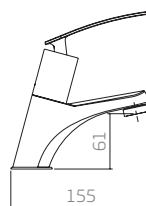
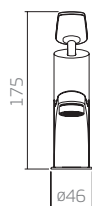

Disponível na versão cromado.
Possui restritor de vazão constante 8 l/m.

1172.VA.KD
torneira lavatório mesa fechamento automático

1172.VB.KD
torneira lavatório mesa fechamento automático

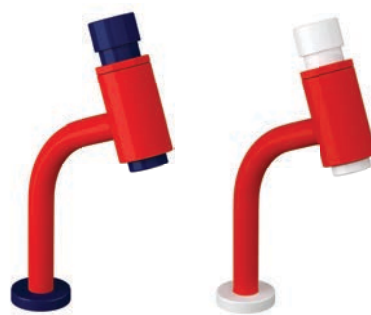
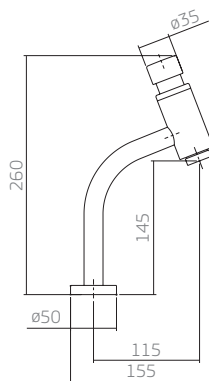

DADOS TÉCNICOS	
Entrada de água	DN 15 (1/2)"
Pressão de serviço	2 a 40 m.c.a

dimensões em milímetros



1171.C
torneira para lavatório bica alta
parede com fechamento automático
DN15/DN20 Decamatic Eco

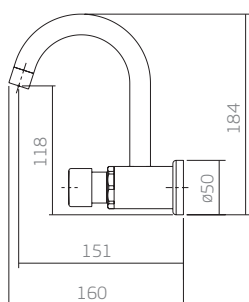

Possui restritor de vazão constante de 6 l/min.

1175.C
torneira para lavatório bica alta
mesa com fechamento automático
DN15/DN20 Decamatic Eco

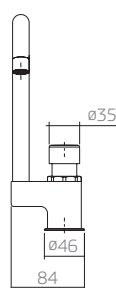
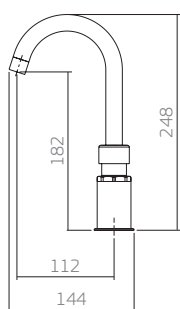

Possui restritor de vazão constante de 6 l/min.

1172.C
torneira lavatório parede
fechamento automático

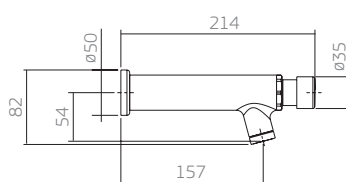

Possui restritor de vazão constante de 8 l/min.



Disponível na versão cromado.
Atende a norma ABNT NBR 13713.

dimensões em milímetros

1173.C
torneira lavatório mesa
fechamento automático

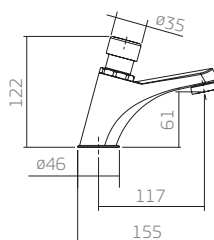

Possui restritor de vazão constante de 8 l/min.

1176.C
torneira lavatório parede
fechamento automático

4976.C
acabamento torneira
lavatório parede
fechamento automático

4576.000
base torneira
lavatório parede
fechamento automático

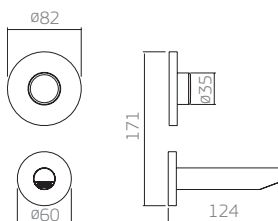

NOVO



Disponível na versão cromado.
Atende a norma ABNT NBR 13713.

dimensões em milímetros

2572.C
válvula mictório
fechamento automático

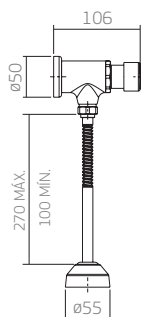

Possui restritor de vazão constante de 8 l/min.

2573.C
válvula para mictório
fechamento automático

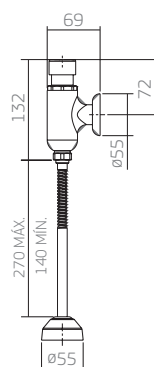

Possui restritor de vazão constante de 8 l/min.

2574.C
válvula de mictório
embutida fechamento
automático

NOVO

4974.C
acabamento válvula de
mictório fechamento
automático

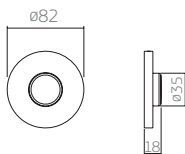

4574.000
base válvula de mictório
fechamento automático



Disponível na versão cromado.
Atende a norma ABNT NBR 13713.

dimensões em milímetros

- Cartucho cerâmico.
- Temperatura de Trabalho: máx. 70°C.
- Homologado: NF, ASME, DIN, CSA, KIWA.
- Vida Útil: 500.000 ciclos (Conforme teste CSA -
- Canadian St. Association).
- Acionamento suave.
- Rápida seleção da temperatura desejada.
- Dispositivo de economia de água e energia (regulagem de vazão máxima e temperatura).

2993.C36.034

monocomando para chuveiro baixa e alta pressão

4993.C36.CHU

acabamento de monocomando para chuveiro baixa e alta pressão

4993.C36.ACT

acabamento de monocomando para ducha higiênica baixa e alta pressão

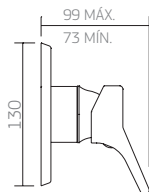

2994.C36*

monocomando para chuveiro com desviador para banheira

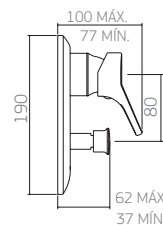
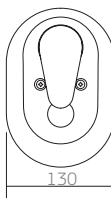

Recomendável com pressão mínima de 6 m.c.a para aquecedor de passagem e de 2 m.c.a para aquecedor de acumulação.

2875.C36

monocomando lavatório mesa

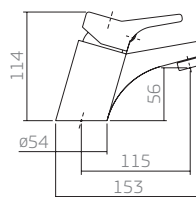

Recomendável com pressão mínima de 6 m.c.a para aquecedor de passagem e de 2 m.c.a para aquecedor de acumulação.

2895.C36

monocomando para bidê

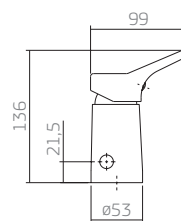

Recomendável com pressão mínima de 6 m.c.a para aquecedor de passagem e de 2 m.c.a para aquecedor de acumulação.

Disponível na versão cromado
Diâmetro dos furos de tampo para lavatório 37 mm.

dimensões em milímetros

- Cartucho cerâmico.
- Temperatura de Trabalho: máx. 70°C.
- Homologado: NF, ASME, DIN, CSA, KIWA.
- Vida Útil: 500.000 ciclos (Conforme teste CSA - Canadian St. Association).
- Acionamento suave.
- Rápida seleção da temperatura desejada.
- Dispositivo de economia de água e energia (regulagem de vazão máxima e temperatura).

2993.C71.034
monocomando para chuveiro baixa e alta pressão

4993.C71.CHU
acabamento de monocomando para chuveiro baixa e alta pressão

4993.C71.ACT
acabamento de monocomando para ducha higiênica baixa e alta pressão

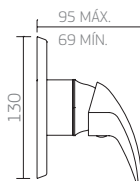

2994.C71
monocomando para chuveiro com desviador para banheira

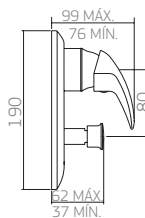
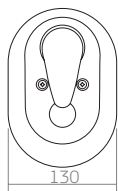

Recomendável com pressão mínima de 6 m.c.a para aquecedor de passagem e de 2 m.c.a para aquecedor de acumulação.

2875.C71
monocomando lavatório mesa

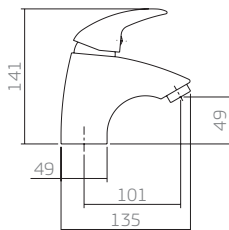

Recomendável com pressão mínima de 6 m.c.a para quecedor de passagem e de 2 m.c.a para aquecedor de acumulação.

2895.C71
monocomando para bidê

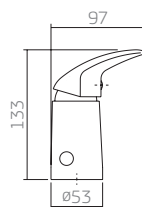

Recomendável com pressão mínima de 6 m.c.a para quecedor de passagem e de 2 m.c.a para aquecedor de acumulação.

Disponível na versão cromado
Diâmetro dos furos de tampo para lavatório 37 mm.

dimensões em milímetros

- Temperatura do banho programável e constante, garantindo conforto no banho.
- O volume de água misturada é controlada por um registro integrado ao aparelho que não interfere na temperatura.
- Possui dois volantes - um para regulagem de vazão (superior) e outro para regulagem da temperatura (inferior).
- Trava de segurança a 38°C.
- Seletor de temperatura que permite a programação de 20° a 60°C.
- Entrada e saída de água de 3/4".
- Regulagem de vazão na entrada de água fria e quente.
- Funciona em alta e baixa pressão. Quando instalado para utilização em mais de um ponto, considerar pressão mínima de 10 m.c.a.

QUADRATTA CLÁSSICA

2430.C85
misturador termostato
Quadratta Clássica

4430.015 base Decaterm
4994.C85 acabamento cromado

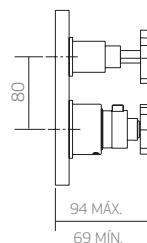
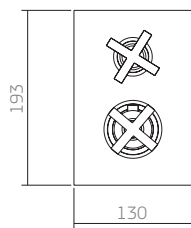

DUNA CLÁSSICA

2430.C64
misturador termostato
Duna Clássica

4430.015 base Decaterm
4994.C64 acabamento cromado

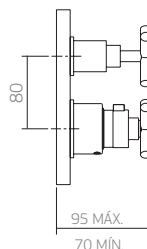
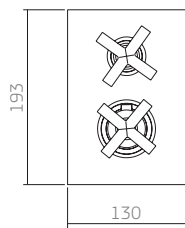

DECATERM

2430.C.034
misturador termostato
Decaterm (cromado)

2430.D.034
misturador termostato
Decaterm (dourado)



4430.034 base Decaterm
4994.C acabamento Decaterm cromado
4994.D acabamento Decaterm dourado

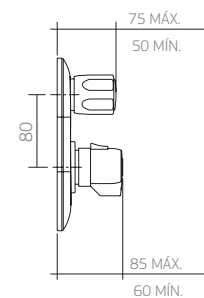
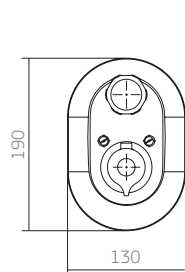

dimensões em milímetros

MISTURADOR TERMOSTATO

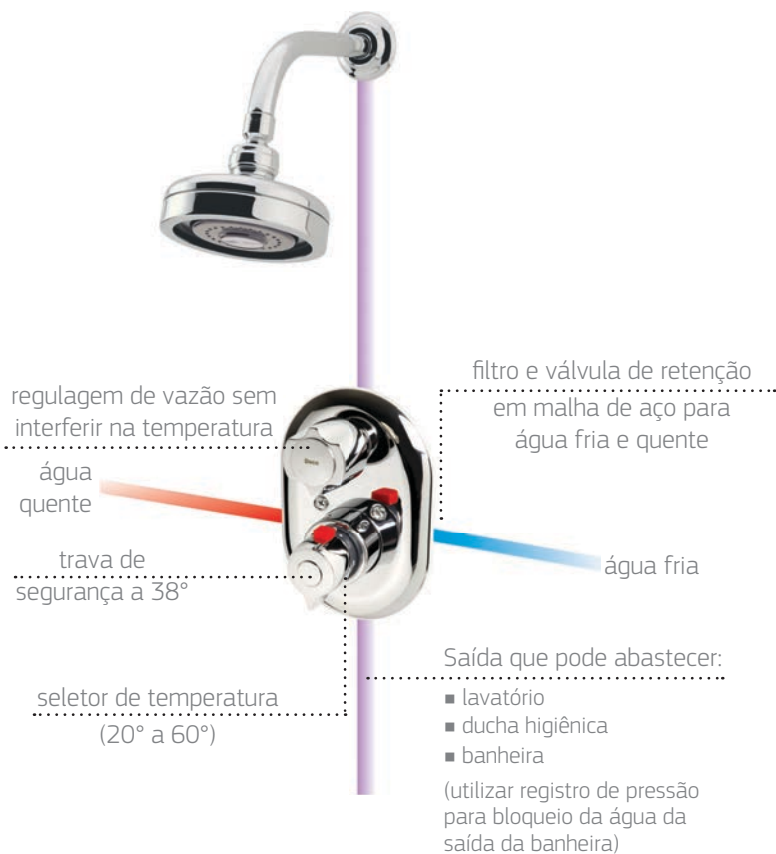

Recomendada a utilização somente com aquecedores de acumulação.
 Para aquecedores de passagem a gás com controle automático de chama.
 A pressão mínima de utilização deverá ser de 15 m.c.a.

VARIAÇÃO DE TEMPERATURA ÁGUA TEMPERADA X ÁGUA QUENTE

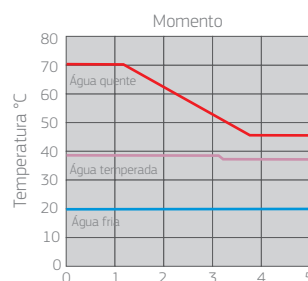

COMO INTERPRETAR O GRÁFICO
 Ex: Embora a temperatura tenha variado de 70°C a 45°C, a temperatura da água misturada variou apenas 1°C (de 39°C a 38°C)

OPÇÕES DE UTILIZAÇÃO:



dimensões em milímetros

MICTÓRIO SAVE DECA

Mictório Save Deca não necessita de água. É a solução econômica e ecológica para seu estabelecimento. É mais fácil e rápido de instalar, com ele você não precisa acrescentar pontos de água. O usuário não precisa apertar a descarga, ou seja, é mais higiênico e prático.

Veja por quê:

- Possui sistema interno de vedação por membrana.
- Ambiente higiênico: menor proliferação de bactérias.
- Não deixa odores: vedação por membrana que evita o retorno do mau cheiro
- Alta durabilidade: cartucho que dura 7.500 ciclos;
- Fácil higienização: o mictório deve ser **pulverizado** uma vez ao dia com solução de água e detergente com PH neutro e limpo com pano macio;

TECNOLOGIA QUE FAZ A DIFERENÇA

O anel superior tem as seguintes funções:

- Detergente: faz a limpeza da válvula e da tubulação.
- Desodorizador: mantém o ambiente livre de mau cheiro e perfumado, sem a necessidade de aplicação de outros produtos (ex: pastilhas, naftalina, limão e gelo).
- Sinalizador visual: aponta a hora certa de trocar. Quando o anel perde a cor, é o momento de trocar o refil.

Obs: o cartucho e a chave para troca acompanham os mictórios Save e Save Design.



Na parte interna você tem:

- Válvula com sistema interno de vedação por membrana: evita que o mau cheiro do esgoto retorne para o ambiente.

RECOMENDAÇÕES DE INSTALAÇÃO

Para uso confortável do mictório, são recomendadas as seguintes medidas de instalação:

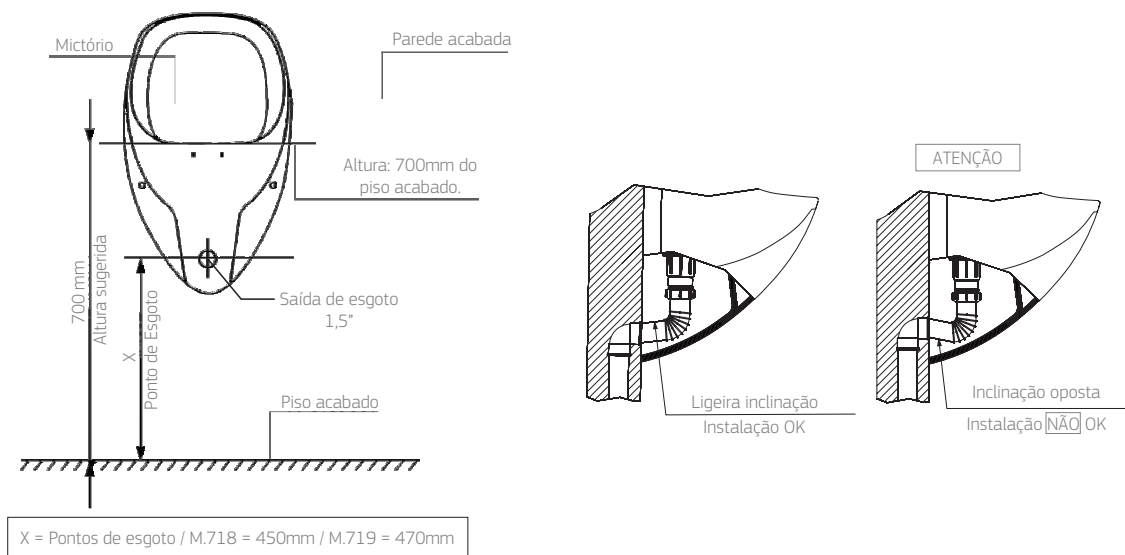

M.719
mictório com
sifão integrado

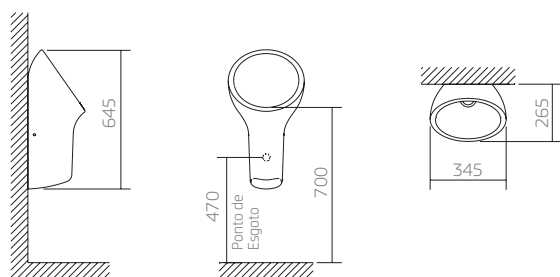

Acompanha fixação.

M.718
mictório com
sifão integrado

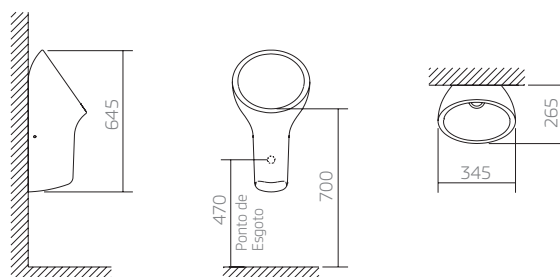

Utilizar SP.13 para fixação

SD.01.01
cartucho mictório save



dimensões em milímetros

4224.010
arejador, autolimpante, com
vazão de 4,5 litros/minuto

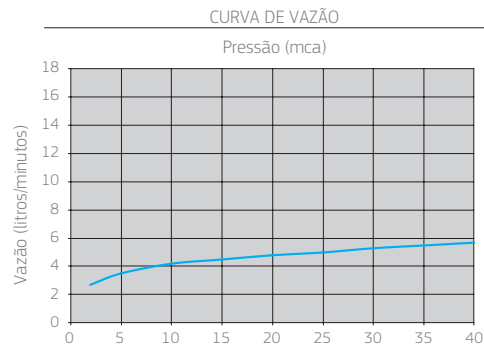

4224.011
dispersor, antibactéria, com
vazão de 6 litros/minuto

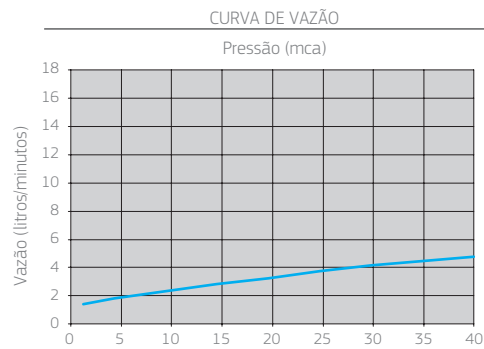

4224.012
dispersor com vazão
de 1,8 litros/minuto

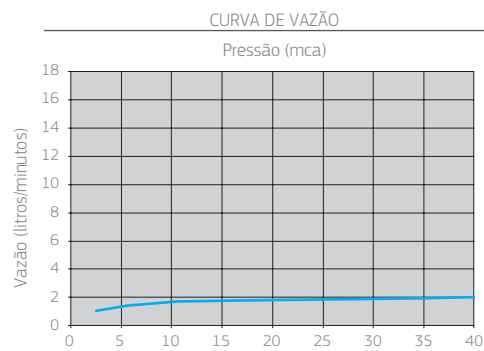

RESTRITORES E AREJADORES

4224.013
dispensador com vazão
de 3,6 litros/minuto

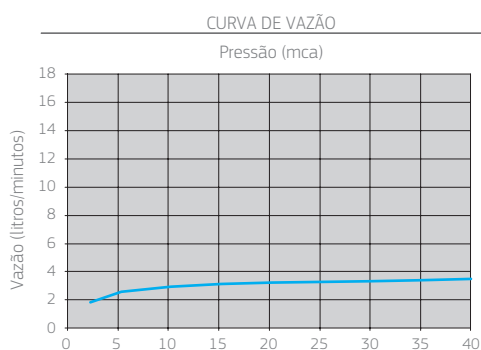

4224.000
arejador com vazão
de 6 litros/minuto

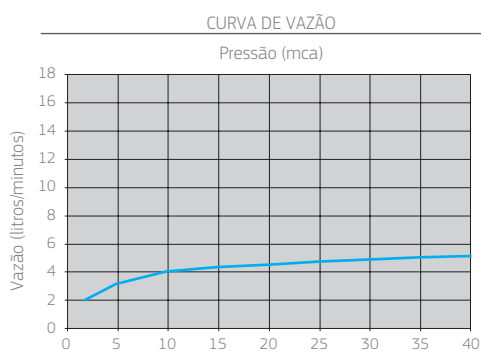

4224.009
arejador com vazão
de 8 litros/minuto

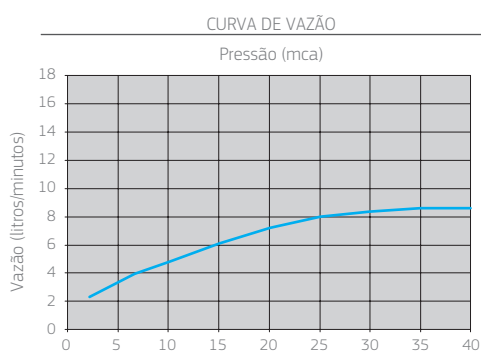

- Reduz o consumo de água em até 50% nas torneiras, misturadores e monocomandos e até 60% no banho;
- Mantém a vazão constante - Recomendado para pressões acima de 10 m.c.a.;
- Produtos embutidos: não permitem acesso ao usuário;

4176.000
dispositivo restritor de vazão
para torneiras sem arejador
de 6 litros/minuto

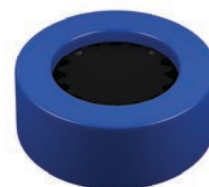
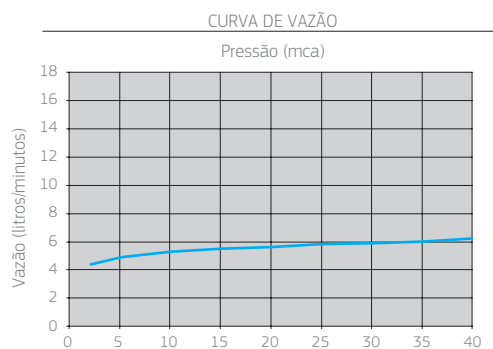

4266.065
dispositivo restritor de vazão
para torneiras sem arejador
de 8 litros/minuto

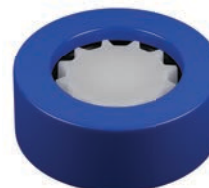
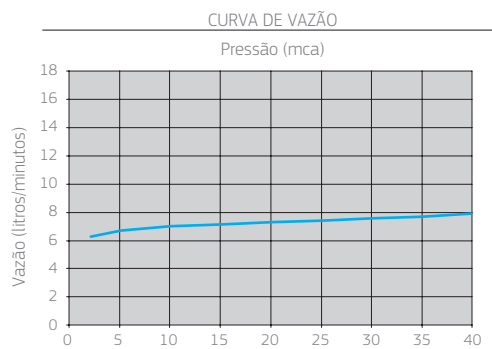

RESTRITORES E AREJADORES

4266.695
dispositivo restritor de vazão
de 10 litros/minuto

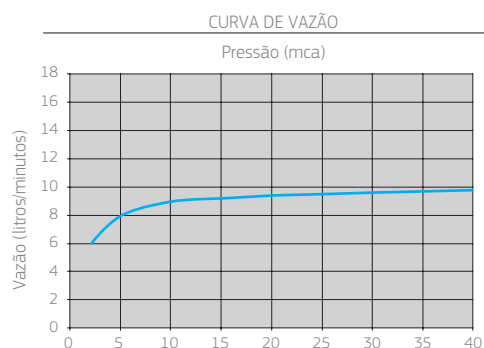

4266.061
dispositivo restritor de vazão
de 8 litros/minuto

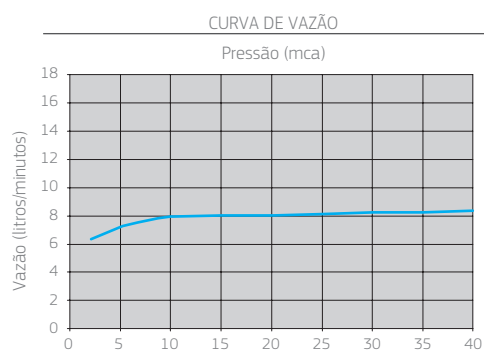

4266.062
dispositivo restritor de vazão
de 14 litros/minuto

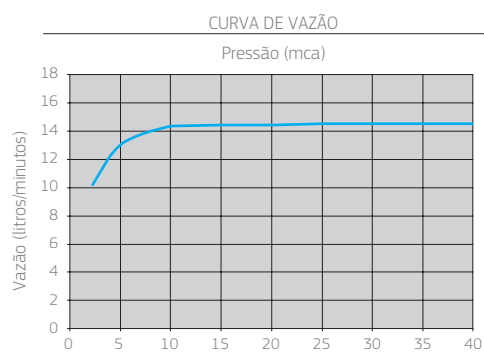

- Versão antivandalismo: Removível somente com chave especial que acompanha o produto;
- Mantém a vazão constante;
- Recomendado para pressões acima de 10 mca;
- Proporciona maior economia e aumenta o conforto do usuário.

4266.059
dispositivo restritor de vazão
de 16 litros/minuto

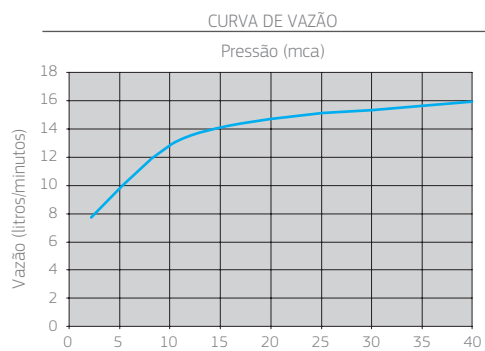

4290.023
arejador com adaptador



dimensões em milímetros

RESTRITORES E AREJADORES

4666.095
uso público com
chave antivandalismo

4666.090
uso público sem
chave antivandalismo

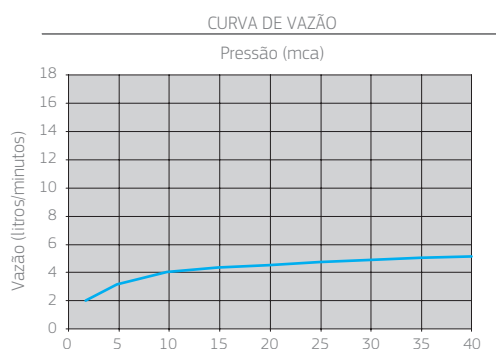

Possui arejador de vazão constante de 6 l/min.

4666.002
uso público com
chave antivandalismo

4666.004
uso público sem
chave antivandalismo

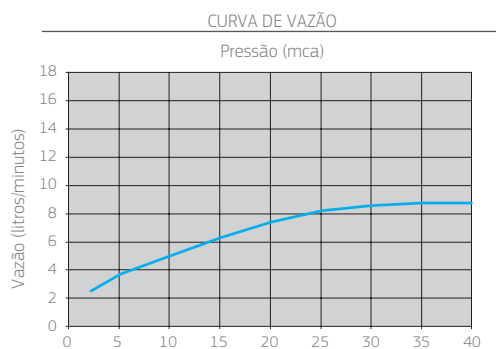

Possui arejador de vazão constante de 8 l/min.

4266.190
adaptador para dispositivo restritor de vazão
DN15 1/2" B8P



dimensões em milímetros



DN150

BÁSICOS

REGISTROS BRUTOS	399
BASE FÁCIL	401
REGISTROS DE GAVETA 1510 HD - BASE FÁCIL	402
REGISTROS DE PRESSÃO - BASE FÁCIL	404
REGISTROS DE PRESSÃO	406
REGISTROS DE GAVETA - BASE FÁCIL	407
REGISTROS DE GAVETA	409
TORNEIRA DE BÓIA	411
BASE DE MONOCOMANDO - BASE FÁCIL	412
BASES	413
DRY WALL	415
BASE - DRY WALL	418
COMPLEMENTOS DRY WALL	420
FILTROS	421

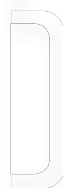

1416.B
registro de pressão bruto

BITOLA	A	B	C	øD
DN 15 (½")	59	44	107	48
DN 20 (¾")	58	39	102	48

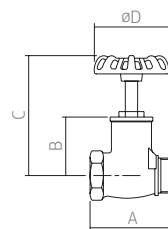

Atende à norma brasileira NBR 15704-1 de Instalação Hidráulica Predial.

1510.HD
registro de gaveta uso
predial, residencial e ar
comprimido de ½" a 4"

BITOLA	A	B	C	øD
DN 15 (½")	40	35	80	47
DN 20 (¾")	42	48	90	55
DN 25 (1")	47	60	110	62
DN 32 (1 ¼")	54	75	130	69
DN 40 (1 ½")	57	87	140	75
DN 50 (2")	72	92	210	79
DN 65 (2 ½")	89	114	249	100
DN 80 (3")	96	140	275	114
DN 100 (4")	130	215	361	156

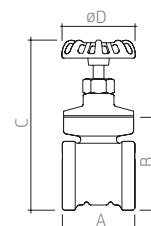

Atende à norma brasileira NBR 15705 de Instalação Hidráulica Predial.

dimensões em milímetros

1552.B
válvula de esfera
passagem plena

BITOLA	A	B	C	∅D
DN 15 (1/2)	44	63	86	26
DN 20 (3/4)	54	74	86	33
DN 25 (1)	79	81	86	40
DN 32 (1 1/4)	91	98	133	50
DN 40 (1 1/2)	98	107	133	56
DN 50 (2)	122	127	133	70

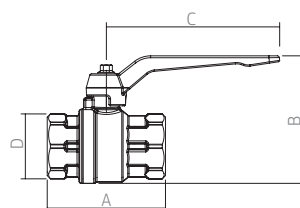

1502.B
uso semi-industrial
registro de gaveta
bruto classe de
pressão Pn16 1/2" a 4"

BITOLA	A	B	C	∅D
DN 15 (1/2")	46	35	102	47
DN 20 (3/4")	52	42	115	55
DN 25 (1")	57	52	136	62
DN 32 (1 1/4")	62	65	150	69
DN 40 (1 1/2")	67	76	170	75
DN 50 (2")	74	93	210	85
DN 65 (2 1/2")	93	117	250	95
DN 80 (3")	100	143	294	109
DN 100 (4")	140	195	340	156

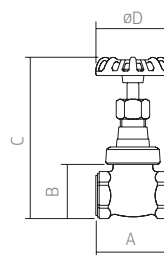

Indicado para uso residencial/predial, conforme norma NBR 15705 e ar comprimido até 55 mca (80psi)

dimensões em milímetros

BASE FÁCIL DECA

Tecnologia, Economia e Durabilidade

Tecnologia: a Base Fácil, foi projetada para ser a maneira mais inteligente de montar seu registro. Sua tecnologia inovadora permite o ajuste após a instalação, evitando o problema de desalinhamento com a parede.

Economia: você elimina o uso de diversos materiais para fazer o serviço, ganhando tempo na instalação dos produtos.

Durabilidade: a Base Fácil Deca foi desenvolvida seguindo os mais rigorosos testes, o que garante a qualidade e a segurança da marca Deca.

Elimina o uso de:

■ adaptadores macho e fêmea

■ fita veda-rosca

■ alicate bico de papagaio



Alinhamento fácil

A Base Fácil Deca é a única que permite corrigir erro de alinhamento mesmo após a instalação.

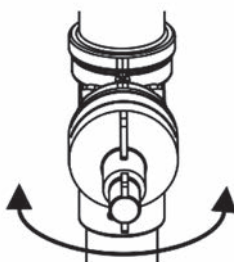

Disponíveis para as tubulações:

PVC: 20mm / 25mm

PPR: 20mm / 25mm

CPVC: 15mm / 22mm / 28mm

EQUIVALÊNCIA DE MEDIDAS		
	Base convencional	Base fácil
TUBULAÇÃO	POLEGADAS	MILÍMETROS
PVC E PPR	1/2	20
	3/4	25
CPVC	1/2	15
	3/4	22
	1	28

dimensões em milímetros

REGISTROS DE GAVETA 1510 HD - BASE FÁCIL

NOVO

1510.HD.102.PVC
base de registro de gaveta HD (20mm)

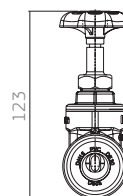
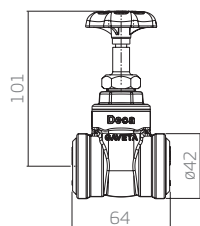

1510.HD.102.PPR
base de registro de gaveta HD (20mm)

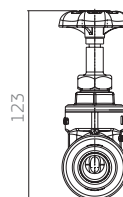
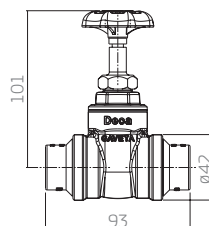

1510.HD.102.CPVC
base de registro de gaveta HD (15mm)

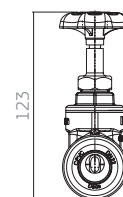
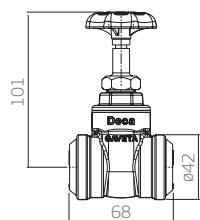

1510.HD.202.PVC
base de registro de gaveta HD (25mm)

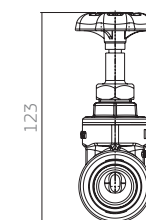
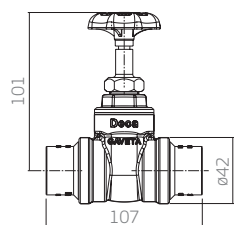

dimensões em milímetros



1510.HD.202.PPR
base de registro de gaveta HD (25mm)

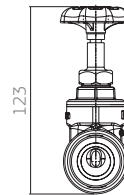
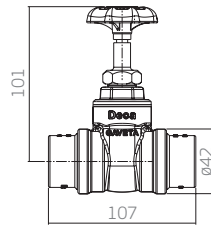

1510.HD.202.CPVC
base de registro de gaveta HD (22mm)

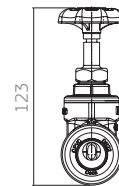
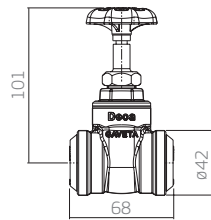

1510.HD.302.CPVC
base de registro de gaveta HD (28mm)

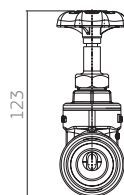
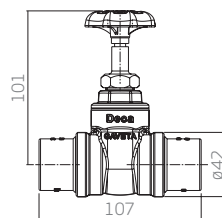

dimensões em milímetros

REGISTROS DE PRESSÃO - BASE FÁCIL

4416.102.PVC
base de registro de pressão (20mm)

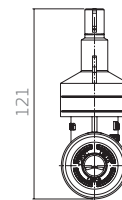
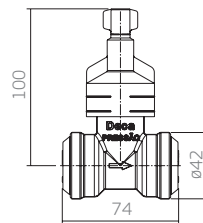

4416.102.PPR
base de registro de pressão (20mm)

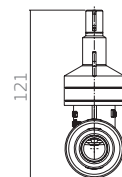
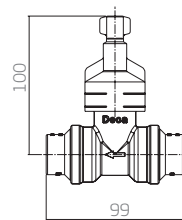

4416.102.CPVC
base de registro de pressão (15mm)

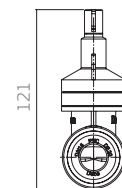
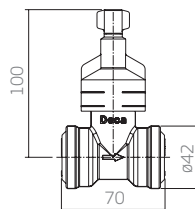

4416.202.PVC
base de registro de pressão (25mm)

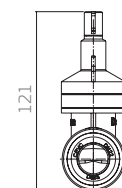
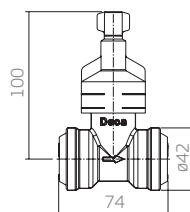

dimensões em milímetros

4416.202.PPR
base de registro de pressão (25mm)

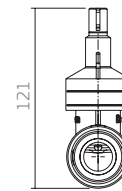
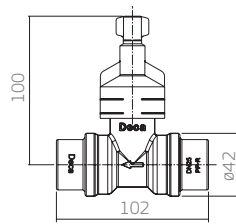

4416.202.CPVC
base de registro de pressão (22mm)

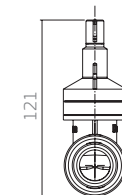
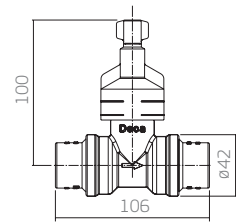

4416.302.PVC
base e registro de pressão (28mm)

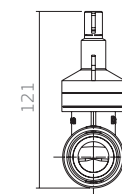
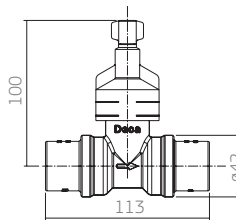

dimensões em milímetros

4416
base de registro de pressão MVS

CÓDIGOS	BITOLA	A	MÍN	MÁX	B
4416.102	DN 15 (½")	59	35	45	99
4416.202	DN 20 (¾")	58	30	40	94

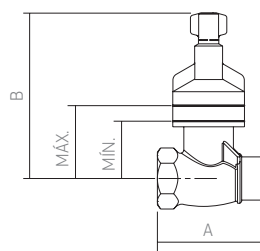

A parede com acabamento deve ficar entre a marcação máx/mín.

MAX

1416.C34.034
registro de pressão

Cromado.



ASPEN

1416.C35.034
registro de pressão

Cromado.



STANDART

1416.C39.034
registro de pressão

Cromado.



SPOT

1416.C43.034
registro de pressão

Cromado.



TARGA

1416.C40.034.CR
registro de pressão

Cromado, cromado com preto e branco.



PRATA

1416.C50.034
registro de pressão

Cromado.



Os registros básicos da Deca possuem corpo em bronze e mecanismos de vedação com materiais de engenharia que garantem alta durabilidade.

Qualidade indubitável há mais de quarenta anos, resultado na certificação ISO 9002, e 10 anos de garantia comprovada com certificado que acompanha os produtos.

Atende à norma brasileira NBR 15704-1 de Instalação Hidráulica Predial.

dimensões em milímetros

4509.102.PVC
base de registro de gaveta (20mm)

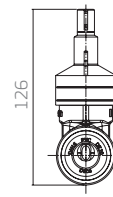
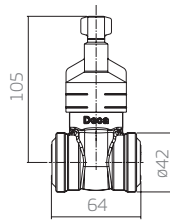

4509.102.PPR
base de registro de gaveta (20mm)

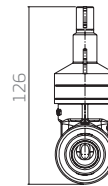
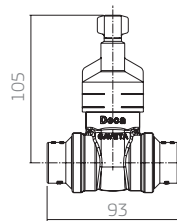

4509.102.CPVC
base de registro de gaveta (15mm)

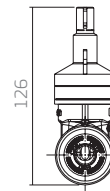
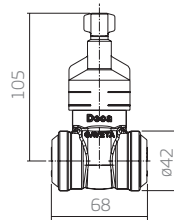

4509.202.PVC
base de registro de gaveta (25mm)

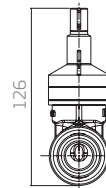
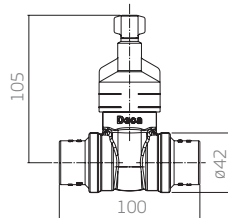

dimensões em milímetros

REGISTROS DE GAVETA - BASE FÁCIL

4509.202.PPR
base de registro de gaveta (25mm)

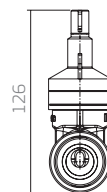
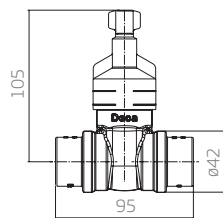

4509.202.CPVC
base de registro de gaveta (22mm)

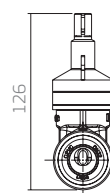
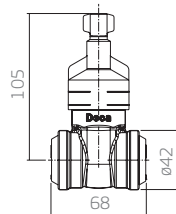

4509.302.CPVC
base de registro de gaveta (28mm)

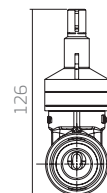
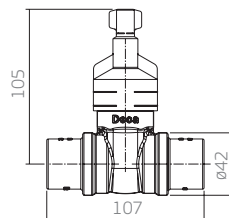

dimensões em milímetros

4509 base de registro de gaveta

CÓDIGOS	BITOLA	A	MÍN	MÁX	B
4509.102	DN 15 (½")	40	32	42	96
4509202	DN 20 (¾")	52	36	46	100
4509.302	DN 25 (1")	52	49	59	114
4509.402	DN 32 (1 ¼")	60	48	58	135
4509.502	DN 40 (1 ½")	60	52	62	139

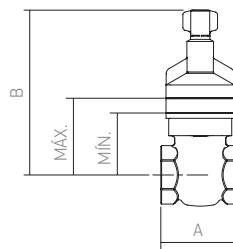

Antes de instalar verifique se o registro está completamente fechado.
A parede com acabamento deve ficar entre a marcação máx/mín.

MAX

1509.C34.034
registro de gaveta

Cromado.



ASPEN

1509.C35.034
registro de gaveta

1509.C35.112
registro de gaveta

Cromado.



STANDART

1509.C39.034
registro de gaveta

Cromado.



As bases de registro Deca podem ser utilizadas com todas as lihas de acabamento Deca.
Atende à norma brasileira NBR 15705 de Instalação Hidráulica Predial.

dimensões em milímetros

SPOT

1509.C43.034
registro de gaveta

Cromado.



TARGA

1509.C40.034.CR
registro de gaveta

1509.C40.112.CR
registro de gaveta

Cromado.



PRATA

1509.C50.034
registro de gaveta

1509.C50.112.CR
registro de gaveta

Cromado.



As bases de registro Deca podem ser utilizadas com todas as lihas de acabamento Deca.
Atende à norma brasileira NBR 15705 de Instalação Hidráulica Predial.

dimensões em milímetros

1350
torneira de bóia
1/2" a 2"

CÓDIGOS	BITOLA	A	B	C	øD	h
1350 BSA 012	DN 15 (1/2)	364	60	27	122	20
1350 BSA 034	DN 20 (3/4)	365	61	29	122	20
1350 BSA 100	DN 25 (1)	368	64	32	122	20
1350 B 114	DN 32 (1 1/4)	608	100	57	212	70
1350 B 112	DN 40 (1 1/2)	611	103	60	212	70
1350 B 200	DN 50 (2)	754	108	65	224	70

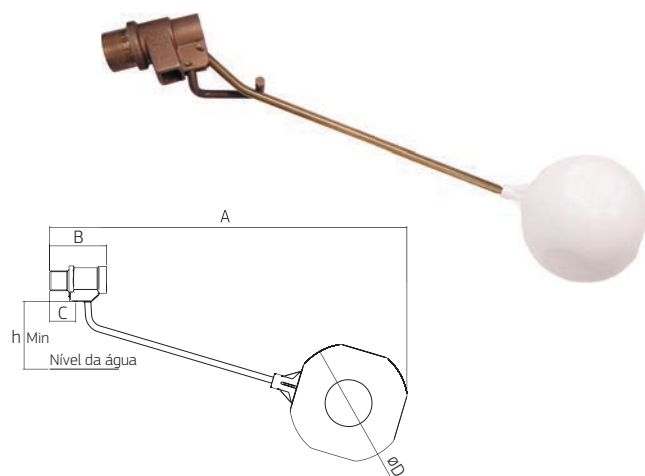

1/2" a 1"

Sede anti-corrosiva (Postiça).
Corpo fundido em bronze.
Balão reforçado em Polietileno.
Maior robustez e confiabilidade
Haste em latão.
Atende as normas NBR 14534 e NBR 5626.

1 1/4" a 2"

Maior eficiência de vedação - Sistema de dupla alavanca.
Corpo fundido em bronze.
Balão reforçado em Polietileno.
Maior robustez e confiabilidade
Haste em latão.
Atende as normas NBR 14534 e NBR 5626.

dimensões em milímetros

BASE DE MONOCOMANDO - BASE FÁCIL

4493.000.PPR
base de monocomando
chuveiro (20mm)

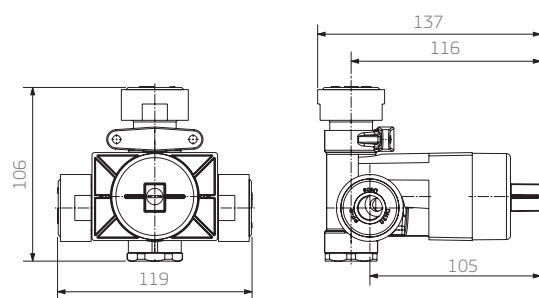

4493.000.CPVC
base monocomando
chuveiro (22mm)

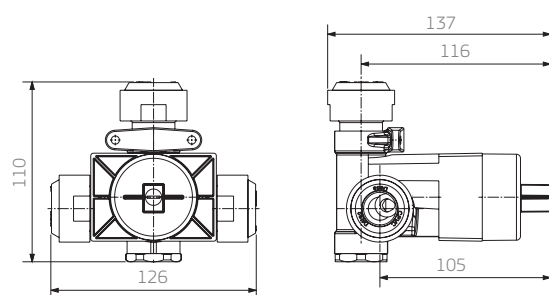

dimensões em milímetros

1983.C.ACT
 ducha manual sem registro

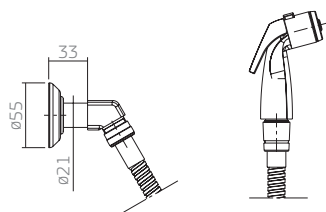

Comprimento do flexível 1,20m.
 Este produto pode ser utilizado com a base 4984.000.

1984.C.LAV
 desviador de lavatório com ducha higiênica
 (acompanha ducha higiênica horizontal)

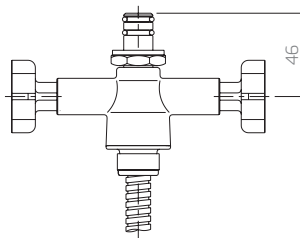

4424.MI.034
 base misturador para chuveiro
 com entrada horizontal

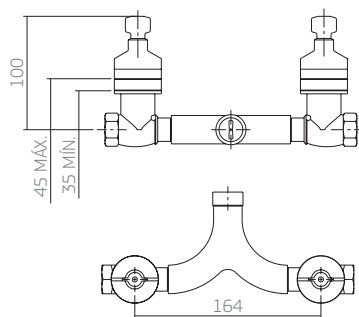

4420.BAN.CHU.202
 base desviador ban-chu

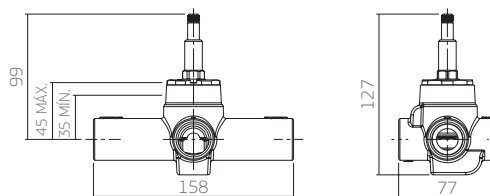

dimensões em milímetros

4493.000
base monocomando chuveiro
alta e baixa pressão

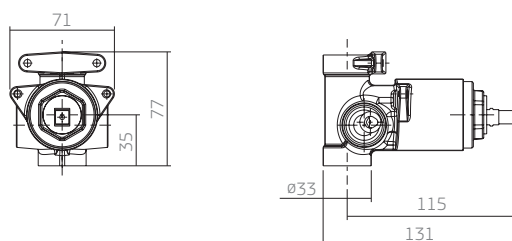

4894.005
base duplo comando
para ducha higiênica

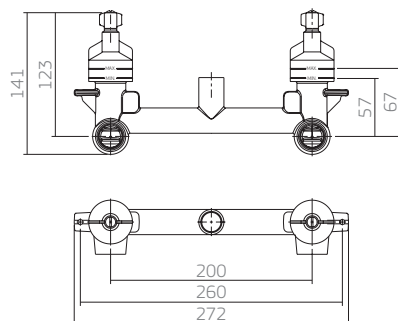

Disponível também completo (acabamento + ducha activa) na versão cromada dos acabamentos Izy e Targa.

4984.000
base msturador
monocomando para ducha

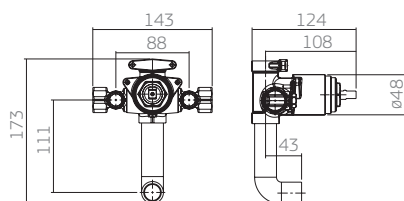

Deve ser utilizado com todos acabamentos de monocomando para ducha higiênica.
Utilizar com ducha activa 1983.C.ACT.

dimensões em milímetros

kit registro de pressão DN20 (¾)

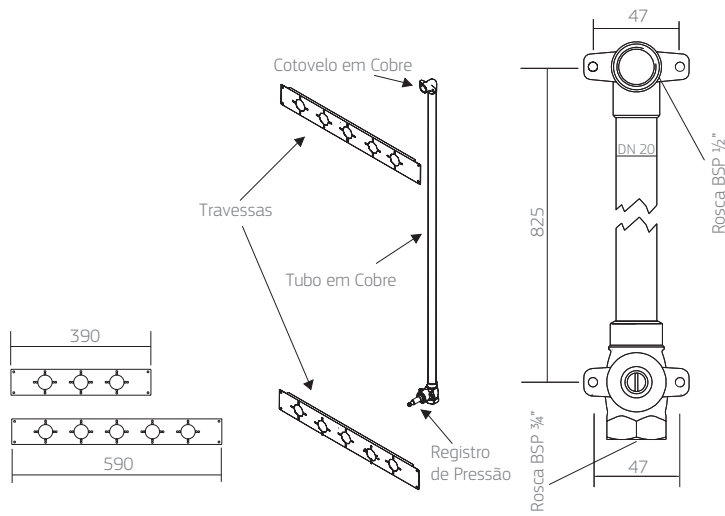

CÓDIGOS	LARGURA ENTRE MONTANTES	INSTALAÇÃO
4416.940	400 mm	MVS II
4416.960	600 mm	MVS II
4416.945	400 mm	MVR
4416.965	600 mm	MVR

dimensões em milímetros

kit monocomando alta e baixa pressão

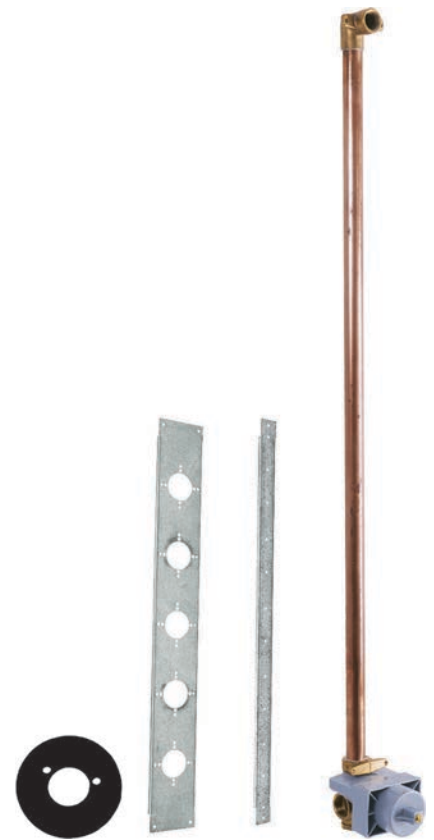
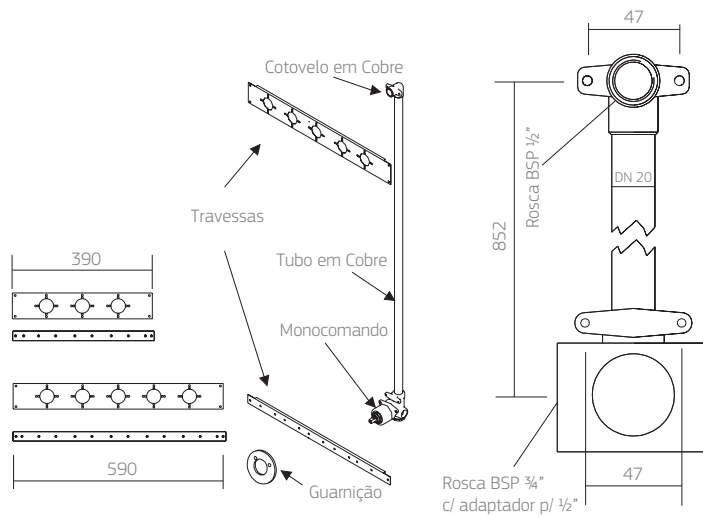

CÓDIGOS	LARGURA ENTRE MONTANTES	INSTALAÇÃO
4993.940	400 mm	ALTA PRESSÃO
4993.960	600 mm	ALTA PRESSÃO

dimensões em milímetros

kit registro de pressão duplo comando com entrada inferior

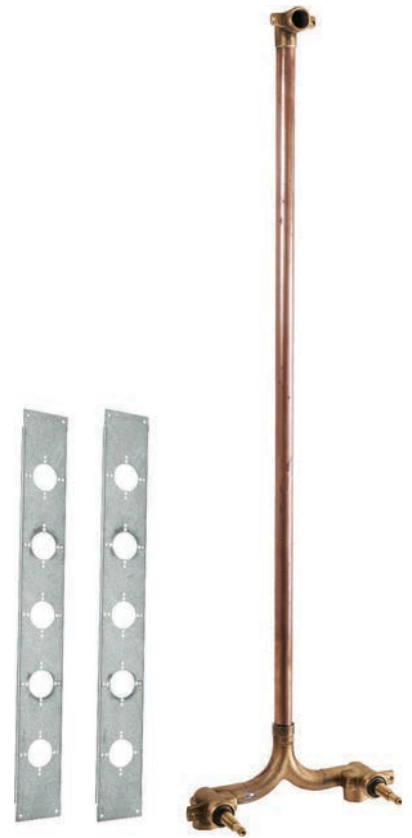
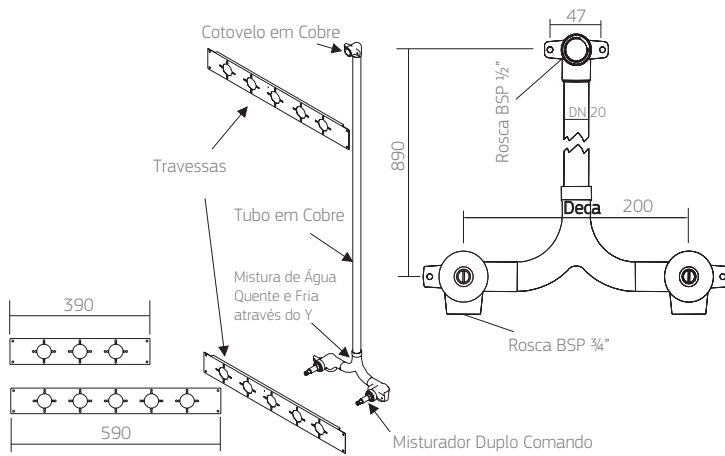

CÓDIGOS	LARGURA ENTRE MONTANTES	INSTALAÇÃO
4424.940	400 mm	MVS II
4424.960	600 mm	MVS II
4424.945	400 mm	MVR
4424.945	600 mm	MVR

dimensões em milímetros

BASE - DRY WALL

base de registro de pressão
4416.215 DN 20 3/4"
sistema de vedação MVS II

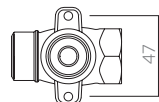
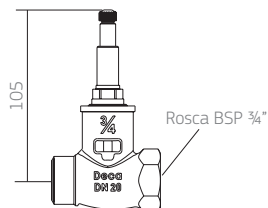

base de registro de gaveta
4509.215 DN 20 3/4"

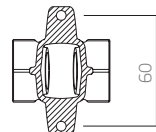
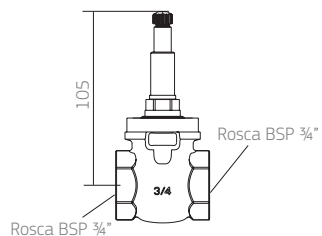

base de registro de pressão
4416.105 DN 15 1/2"
4416.205 DN 20 3/4"
sistema de vedação MVS II

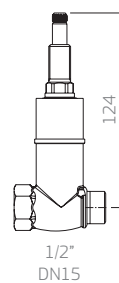
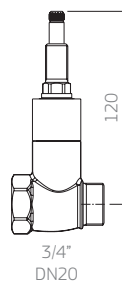

base de registro de gaveta
4509.105 DN 15 1/2"
4509.205 DN 20 3/4"
4509.305 DN 25 1"

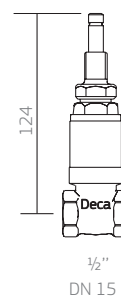
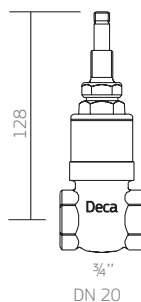
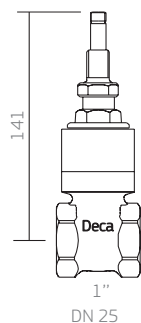

dimensões em milímetros

4493.000
base monocomando para chuveiro
alta e baixa pressão (2 a 40 mca)

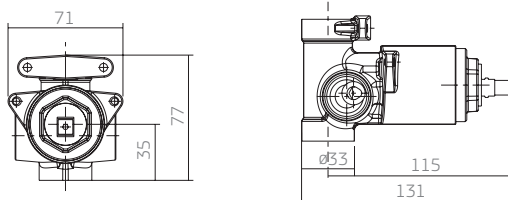

4984.000
base monocomando para
ducha activa (2 a 40 mca)

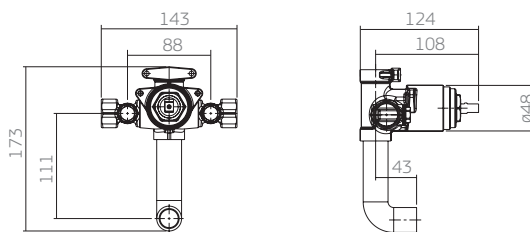

Utilizar com os acabamentos 4993.C.ACT das linhas: Axis, Unic, Decamix, Forum, Smart ou Vougue.
Válvula de retenção incorporada, evitando retroalimentação.

4420.BAN.CHU.202
base desviador
banheira-chuveiro

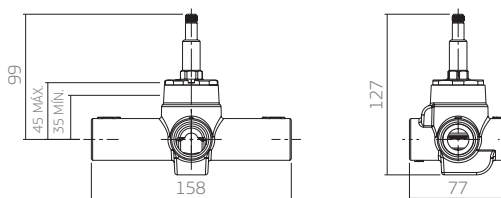

4894.005
base duplo comando para ducha activa

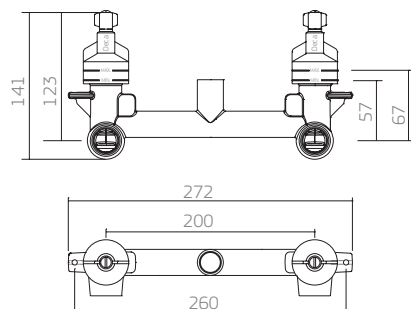

Válvula de retenção incorporada, evitando retroalimentação

dimensões em milímetros

4266.068
conexão de fixação

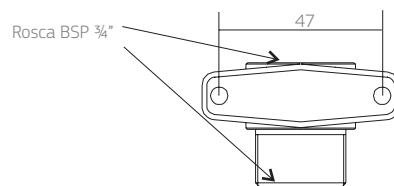

4252.056 - 400 mm
4252.057 - 600 mm
treveça para registros

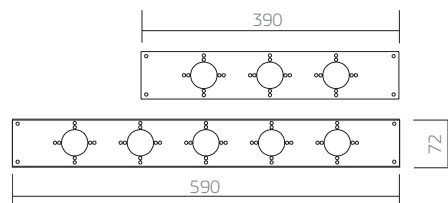

4252.054
4252.055
treveça para monocomandos

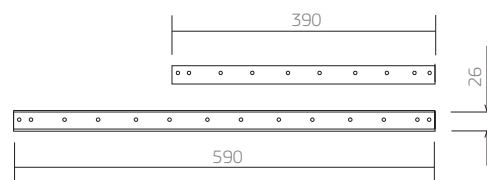

dimensões em milímetros

1330.ENT
filtro de entrada

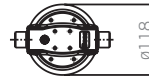
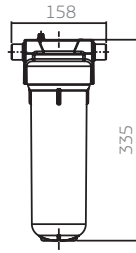

1331.MAQ
filtro para máquina

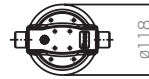
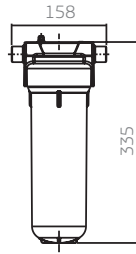

1330.ENT

- Utilizado na entrada de água da residência (cavelete e caixa d'água).
- Evita o entupimento da tubulação, mantém a caixa d'água limpa por mais tempo, protege chuveiros, torneiras e demais registros e evita o disparo da válvula de descarga por incidência de sujeira.
- Retém partículas como areia, barro, ferrugem e outros sedimentos (mínimo de $85\% \geq 15 < 30 \mu\text{m}$) – Classe IV – NBR 14908).
- Mantém o cloro, pois protege a água durante o armazenamento na caixa d'água.
- Vida útil do elemento filtrante aproximadamente 3 meses (a qualidade da água pode influenciar este período).
- Alta vazão 1360 l/h.
- Possui válvula de despressurização que facilita a troca do refl.
- Funciona em alta e baixa pressão.

Modo de instalação:

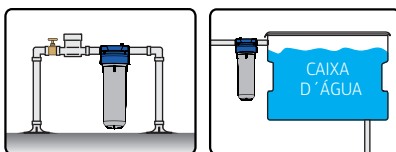

Recomendamos a utilização do POE para aumentar a vida útil e melhorar o desempenho dos seus produtos instalados no sistema hidráulico (torneiras, chuveiros, etc).

1331.MAQ

- Utilizado na entrada da máquina de lavar.
- Aumenta a durabilidade dos componentes da máquina de lavar, reduzindo custos com manutenção. Aumenta a eficiência do sabão em pó e conserva as roupas por mais tempo.
- Retém partículas como areia, barro, ferrugem e outros sedimentos (mínimo de $85\% \geq 5 < 15 \mu\text{m}$) – Classe III – NBR 14908).
- Vida útil do elemento filtrante aproximadamente 3 meses (a qualidade da água pode influenciar este período).
- Alta vazão 1360 l/h.
- Possui válvula de despressurização que facilita a troca do refl.
- Funciona em alta e baixa pressão.

Modo de instalação:

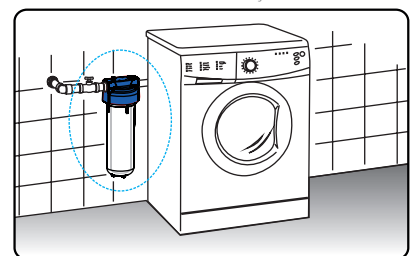

Produtos aprovados pelo Inmetro.

Aparelho para ponto uso em água potável, de acordo com a portaria nº 2914/11 do Ministério da Saúde.

dimensões em milímetros



Hydra

HYDRA

CAIXA DE DESCARGA EMBUTIDA HYDRA	425
ACABAMENTO PARA CAIXA DE DESCARGA EMBUTIDA MECÂNICA	429
ACABAMENTO PARA CAIXA DE DESCARGA EMBUTIDA PNEUMÁTICA	431
SUORTE PARA FIXAÇÃO DE BARRAS DE APOIO	433
DECA SLIM	437
HYDRA DUO	438
HYDRA DUO PRO	439
HYDRA DUO KIDS	440
HYDRA ECO	441
HYDRA ECO PRO	442
HYDRA ECO CONFORTO	443
HYDRA RETRÔ	444
HYDRA PLUS	445
HYDRA MAX	446
HYDRA CLEAN	447
HYDRA PRO	448
BASE HYDRA	449
DICAS DE INSTALAÇÃO	452
KITS CONVERSORES HYDRA	453



Caixa de Descarga Embutida Hydra

A marca Hydra reconhecida como sinônimo de válvula de descarga, passa agora a oferecer mais uma solução de Sistema de Descarga.

Design, inovação, qualidade e principalmente economia de água continuam sendo os principais atributos da marca, que agora com as novas Caixas de descarga embutida, fortalecem mais a marca Hydra.

- Diversas opções de acabamentos, vendidos separadamente; - Sistema de descarga silencioso com proteção acústica.
- Funcionamento em baixa e alta pressão (2 a 40 m.c.a.).
- Sistema de duplo acionamento (3L e 6L) em todas as versões.
- Fácil acesso ao interior para manutenção.
- Mecanismo de enchimento rápido.
- Alimentação de água pela parte superior direita ou esquerda.
- Redução de espaço: Caixa ultra-fina, 80mm de espessura.
- Registro integrado (DN 15 – Ø ½”) para ajuste de vazão e para manutenção.
- Hastes de Fixação de aço Inox.
- Acabamento Soft Touch – proporciona suavidade no toque ao acabamento (somente na versão preto fosco e areia fosco).
- Nossas caixas acompanham todas as conexões necessárias para sua instalação.
- Nossas caixas atendem aos requisitos da norma NBR 15491 (Caixa de descarga para limpeza de bacias sanitárias).
- Todas as nossas caixas e suportes permitem a instalação de bacias convencionais e suspensas respeitando as exigências das normas NBR 15097 – 1, NBR 15097 – 2 e NBR 9050.
- Vedações em silicone, o que garante maior durabilidade e resistência contra possíveis agressões da água.
- Garantia de 10 anos.

dimensões em milímetros

CAIXA DE DESCARGA EMBUTIDA HYDRA

- Exclusivo sistema que permite correção do tubo de saída de água para alinhamento horizontal/vertical em até 2cm.
- Funcionamento em baixa e alta pressão (2 a 40 m.c.a)

2500.CX.MC.AF

(Mecânica)

caixa de descarga embutida Hydra
para alvenaria e drywall (Bacia de piso)

2500.CX.PN.AF

(Pneumática)

caixa de descarga embutida Hydra
para alvenaria e drywall (Bacia de piso)

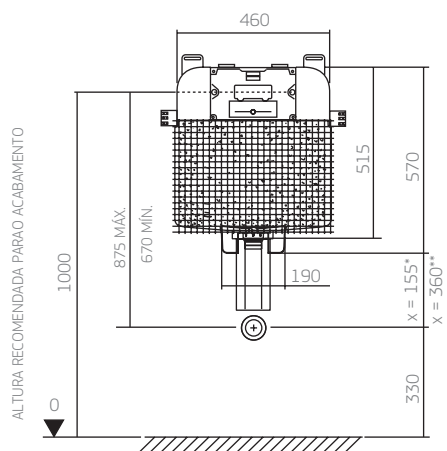

* PARA ACABAMENTO INSTALADO A 1.000 mm

** PARA ACABAMENTO INSTALADO A 1.205 mm

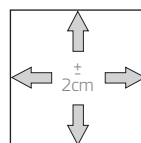
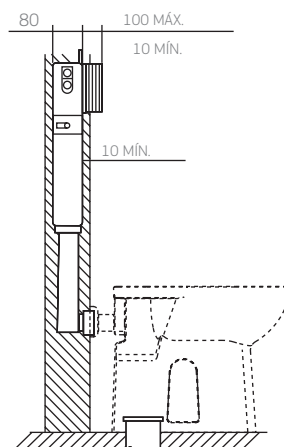

dimensões em milímetros

- Em testes realizados conforme Norma ABNT NBR 15097-2, desde que, as instalações sejam realizadas conforme as exigências descritas nos folhetos de instalação, as bacias instaladas com as caixas 2501 e 2502 suportam até 400 Kg.
- Funcionamento em baixa e alta pressão (2 a 40 m.c.a)

2501.CX.MC.AF

(Mecânica)

caixa de descarga embutida Hydra
para alvenaria (Bacia suspensa)

2501.CX.PN.AF

(Pneumática)

caixa de descarga embutida Hydra
para alvenaria (Bacia suspensa)

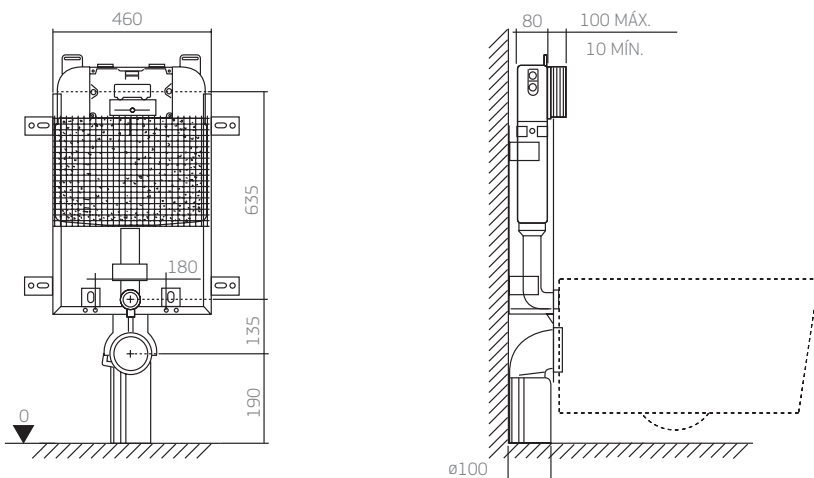

dimensões em milímetros

CAIXA DE DESCARGA EMBUTIDA HYDRA

- Em testes realizados conforme Norma ABNT NBR 15097-2, desde que, as instalações sejam realizadas conforme as exigências descritas nos folhetos de instalação, as bacias instaladas com as caixas 2501 e 2502 suportam até 400 Kg.
- As caixas 2502 possuem um sistema que permitem a regulagem do tudo de saída para os casos em que o ponto de esgoto não esteja alinhado com a parede, podendo ser deslocado para frente e para traz com um range de regulagem de até 50 mm.
- Funcionamento em baixa e alta pressão (2 a 40 m.c.a)
- Fixação no piso e na parede ou somente no piso, utilizando o suporte 1100.SP.134.01.

2502.CX.MC.AF
(Mecânica)
caixa de descarga embutida
Hydra para Drywall
(Bacia suspensa)

2502.CX.PN.AF
(Pneumática)
caixa de descarga embutida
Hydra para Drywall
(Bacia suspensa)

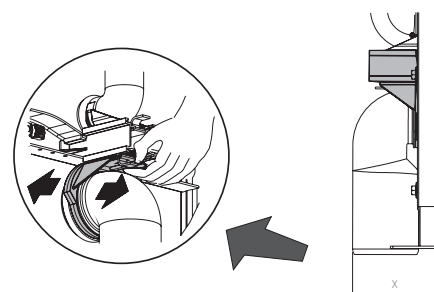
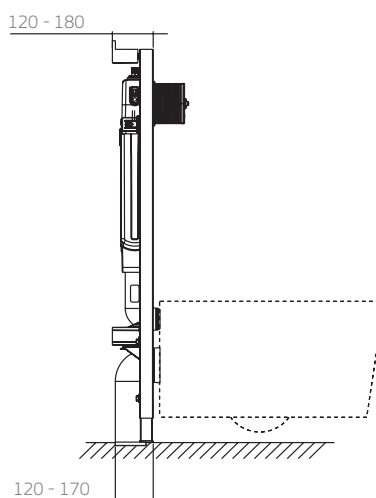
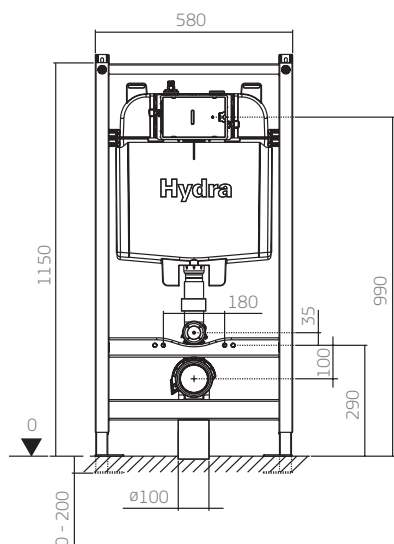

	MIN	MAX
 ø100	x = 120	x = 170

dimensões em milímetros

H SLIM DUO

Cromado

4900.C.HSL.DUO
acabamento para caixa de descarga
embutida mecânica



Branco

4900.E.HSL.DUO.BR
acabamento para caixa de descarga
embutida mecânica



Preto fosco

4900.F.HSL.DUO.PT
acabamento para caixa de descarga
embutida mecânica



Areia

4900.F.HSL.DUO.AR
acabamento para caixa de descarga
embutida mecânica

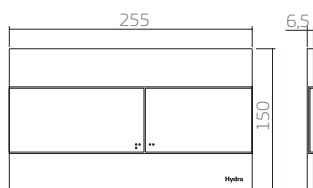
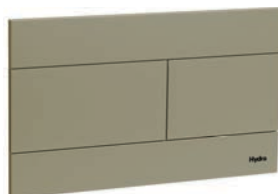

- Acabamento para caixa de descarga embutida mecânica.
- A espessura do acabamento é de apenas 6,5 mm.
- Variedade de cores de acabamentos.
- 10 anos de garantia



Compatível com as caixas: 2500.CX.MC.AF, 2501.CX.MC.AF e 2502.CX.MC.AF

dimensões em milímetros

H PRO DUO

Cromado

4900.C.HPR.DUO
acabamento para
caixa de descarga
embutida mecânica

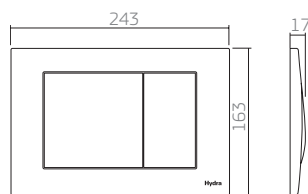
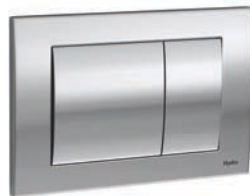

- Acabamento para caixa de descarga embutida mecânica.
- Versão metálica antivandalismo, para uso público.
- 10 anos de garantia



Compatível com as caixas: 2500.CX.MC.AF, 2501.CX.MC.AF e 2502.CX.MC.AF

dimensões em milímetros

H QUADRA DUO

Cromado

4900.C.HQD.DUO
acabamento para caixa de descarga
embutida pneumática



Branco

4900.E.HQD.DUO.BR
acabamento para caixa de descarga
embutida pneumática



Preto fosco

4900.F.HQD.DUO.PT
acabamento para caixa de descarga
embutida pneumática

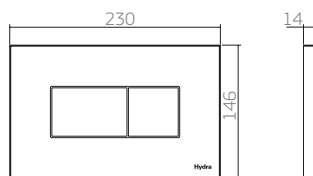
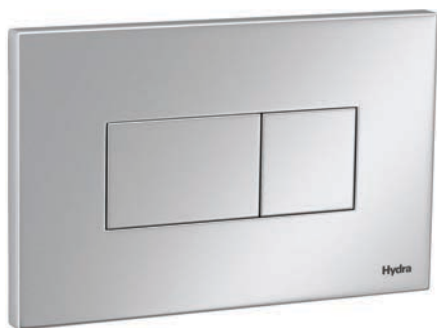

- Acabamento para caixa de descarga embutida pneumática.
- A espessura do acabamento é de apenas 6,5 mm.
- Variedade de cores de acabamentos.
- 10 anos de garantia



Compatível com as caixas: 2500.CX.PN.AF, 2501.CX.PN.AF e 2502.CX.PN.AF.

dimensões em milímetros

H IZY DUO

Cromado

4900.C.HIZ.DUO
acabamento para caixa de descarga
embutida pneumática



Branco

4900.E.HIZ.DUO.BR
acabamento para caixa de descarga
embutida pneumática



Preto fosco com cromado

4900.CF.HIZ.DUO.PT
acabamento para
caixa de descarga
embutida pneumática

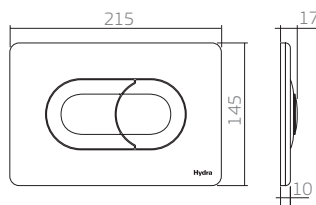

- Acabamento para caixa de descarga embutida pneumática.
- Variedade de cores de acabamentos
- 10 anos de garantia



Compatível com as caixas: 2500.CX.PN.AF, 2501.CX.PN.AF e 2502.CX.PN.AF.

dimensões em milímetros

- Permite a fixação da caixa de embutir diretamente no piso sem necessidade de uma parede.
- Sempre utilizar com o suporte Hydra 1100.SP.133.01 ou com as caixas de embutir 2502.CX.MC.AF ou 2502.CX.PN.AF.
- Estrutura metálica tubular resistente a corrosão com pintura epóxi.
- Com regulagem de altura (até 200mm).

1100.SP.134.01
suporte opcional

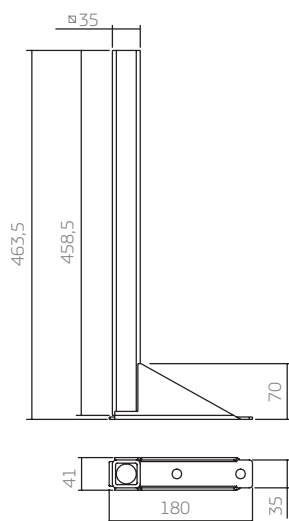
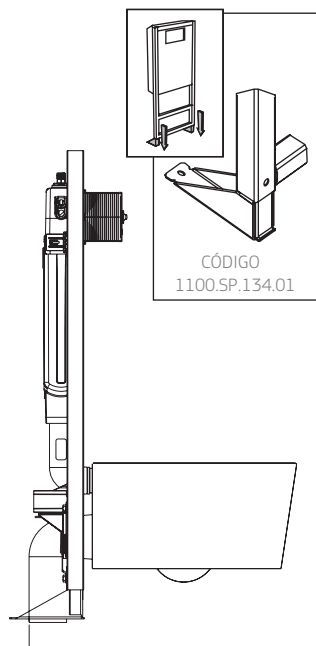

dimensões em milímetros

SUPOORTE PARA CAIXA DE DESCARGA EMBUTIDA

- Facilita a regulagem da altura e o alinhamento na instalação das caixas 2501.CX.MC.AF e 2501.CX.PN.AF, oferecendo maior estabilidade na fixação quando necessário.

1100.SP.135.01
suporte opcional

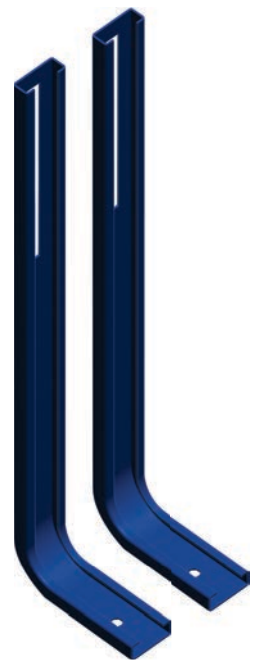
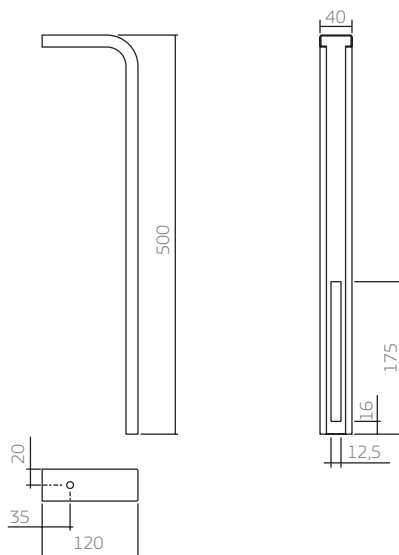
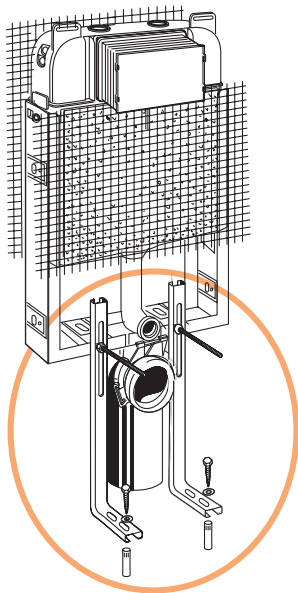

dimensões em milímetros

- Este suporte é indicado para bacia suspensa em parede drywall independente do sistema de descarga utilizado: válvula Hydra ou caixa de embutir Hydra
- Resistente: haste de fixação em aço inox, estrutura metálica resistente a corrosão com pintura epóxi.
- Fixação no chão ou na parede.
- Inclui cotovelo de 100mm regulável em profundidade e acessórios de fixação.
- Com regulagem de altura (até 200mm).

1100.SP.133.01
suporte para instalação
de bacia suspensa em drywall

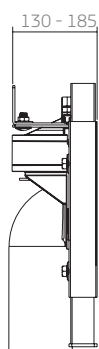
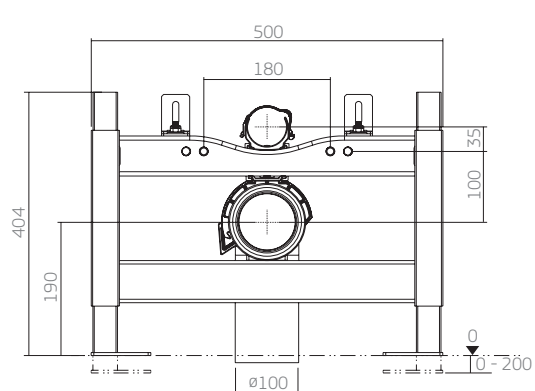

Permite a fixação:

1 - no piso e na parede
(Drywall com alvenaria)

2 - somente no piso (utilizando também o suporte
1100.SP.134.01) (Drywall)

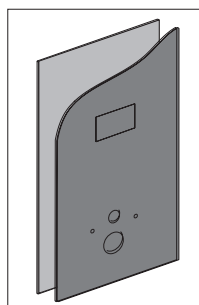
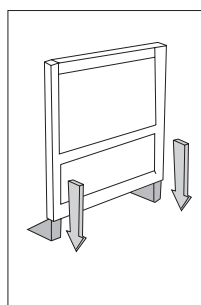
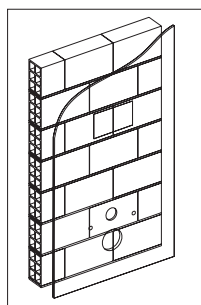
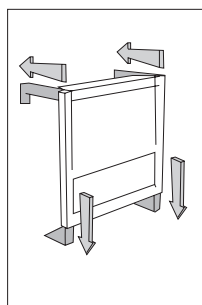

dimensões em milímetros

SUPOORTE PARA FIXAÇÃO DE BARRAS DE APOIO DE APOIO

- Estrutura metálica galvanizada resistente a corrosão.
- Painel de madeira reforçada e resistente a umidade.
- Indicada para fixação de barras de apoio conforto.

1100.SP.136.01
suporte para barras de apoio para
instalação em drywall

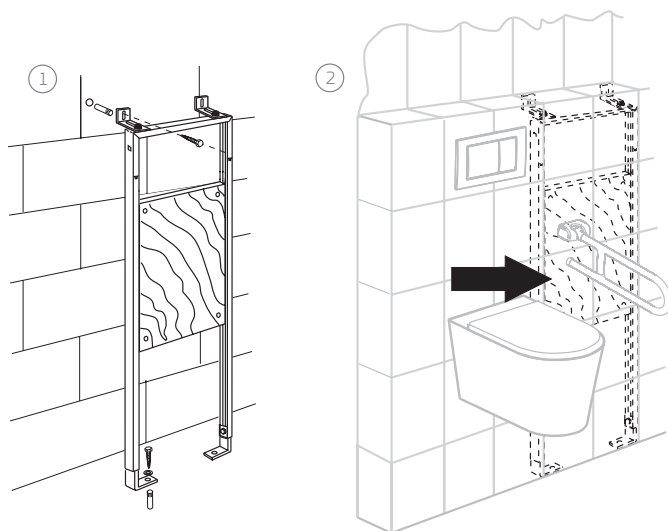

Sugestão de instalação

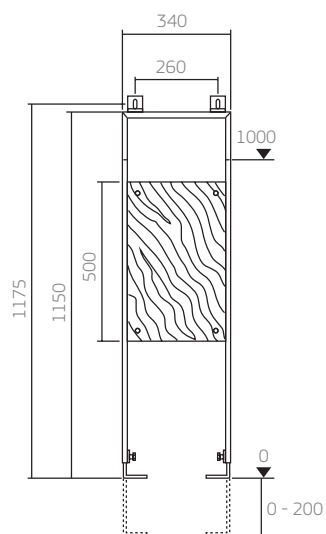

dimensões em milímetros





DECA SLIM

Design diferenciado com espessura de 10mm e mecanismo com tecnologia e qualidade Hydra..



- Ganhadora do prêmio IF Design
- Design inovador
- A espessura do acabamento é de apenas 10mm.
- Acionamento suave através do mecanismo soft touch.
- Possui regulação de vazão
- Pode ser instalada em alta ou baixa pressão
- Pode ser instalada com qualquer bacia convencional
- 10 anos de garantia
- Disponível nas versões cromado, dourado, preto fosco e gold.



PARA ALTA E BAIXA PRESSÃO
20 a 400 KPa - 0,2 a 4,0 Kgf/cm²

A válvula de descarga Deca Slim é fornecida nas bitolas de DN.32 (1 ¼) e DN.40 (1 ½). Ambas podem ser utilizadas em alta ou baixa pressão de 2 a 40 mca

Preto Fosco

4916.F.SLM.PTO
kit conversor Deca Slim



Gold

4916.D.SLIM.GLD
kit conversor Deca Slim



Cromado

2553.C.114 - válvula de descarga
Deca Slim

2553.C.112 - válvula de descarga
Deca Slim

Dourado

2553.D.114 - válvula de descarga
Deca Slim

2553.D.112 - válvula de descarga
Deca Slim

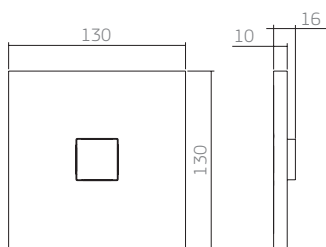

Kit Conversor disponível nas versões: preto fosco e gold.

dimensões em milímetros

HYDRA DUO

Descarga com duplo acionamento

Desenvolvida com base na crescente preocupação com a preservação do meio ambiente, a Hydra Duo é a primeira válvula de descarga com duplo acionamento, agora de cara nova.

Essa inovação garante uma maior economia no consumo de água.

São dois botões que regulam a quantidade de água a ser usada.

1 - Descarga com volume reduzido:
Limpeza rápida (aprox. 3 litros)

2 - Descarga completa:
Limpeza total (aprox. 6 litros)



Válvulas com acabamento metálico

Cromado

2545.C.114 / válvula de descarga Hydra Duo
2545.C.112 / válvula de descarga Hydra Duo
4900.C.DUO / acabamento Hydra Duo



Válvulas com acabamento em ABS

Bege

2545.PC.112.BE / válvula de descarga Hydra Duo
2545.PC.114.BE / válvula de descarga Hydra Duo
4900.PC.DUO / acabamento Hydra Duo



NOVO

Cinza

2545.PC.112.CZ / válvula de descarga Hydra Duo
2545.PC.114.CZ / válvula de descarga Hydra Duo
4900.PC.DUO.CZ / acabamento Hydra Duo



NOVO

Branco

2545.PC.112.BR / válvula de descarga Hydra Duo
2545.PC.114.BR / válvula de descarga Hydra Duo
4900.PC.DUO.BR / acabamento Hydra Duo



NOVO

Preto

2545.PC.112.PT / válvula de descarga Hydra Duo
2545.PC.114.PT / válvula de descarga Hydra Duo
4900.PC.DUO.PT / acabamento Hydra Duo



NOVO

- Descarga com duplo acionamento
- Meia descarga - aprox. 3 litros e descarga completa - aprox. 6 litros
- Acabamento menor
- Acionamento suave através do mecanismo soft touch
- Disponível em duas bitolas:
1 ½ " baixa pressão (2 a 10 mca)
1 ¼ " alta pressão (10 a 40 mca)
- Possui regulagem de vazão
- Material:
Válvula cromada e gold:
Acabamento metálico
Válvulas coloridas:
Acabamento em ABS
- 10 anos de garantia

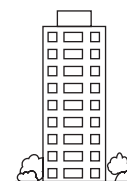

ALTA PRESSÃO
DN 32 (1 ¼")
100 a 400 Kpa
1,0 a 4,0 Kgf/cm²



BAIXA PRESSÃO
DN 40 (1 ½")
20 a 100 Kpa
0,2 a 1,0 Kgf/cm²

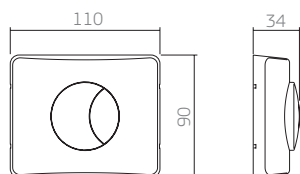

Kit Conversor disponível nas versões: cromado, bege, cinza, branco, preto, gold, kids (vermelho e azul) e kids (vermelho e branco)

dimensões em milímetros

NOVO



HYDRA DUO PRO

Descarga com duplo acionamento

Produto inovador: Anti-vandalismo e sustentável.

São dois botões que regulam a quantidade de água a ser usada.

1 - Descarga com volume reduzido:
Limpeza rápida (aprox. 3 litros)

2 - Descarga completa:
Limpeza total (aprox. 6 litros)

Até
60%
de economia
de água.

- Descarga com duplo acionamento.
- Meia descarga: aprox. 3 litros e descarga completa: aprox. 6 litros.
- Disponível em duas bitolas:
1 1/2" baixa pressão (2 a 10 m.c.a)
1 1/4" alta pressão (10 a 40 m.c.a)
- Possui regulação de vazão.
- Disponível na versão cromada.

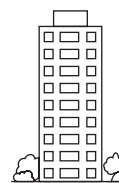

ALTA PRESSÃO
DN 32 (1 ¼)
100 a 400 Kpa
1,0 a 4,0 Kgf/cm²



BAIXA PRESSÃO
DN 40 (1 ½)
20 a 100 Kpa
0,2 a 1,0 Kgf/cm²

Cromado

2545.C.114.PRO
válvula de descarga
Hydra Duo Pro

2545.C.112.PRO
válvula de descarga
Hydra Duo Pro

4900.C.DUO.PRO
acabamento
Hydra Duo Pro

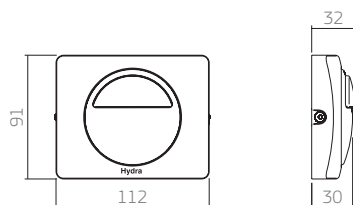

Kit Conversor disponível na versão: cromado.

dimensões em milímetros



HYDRA DUO KIDS

A funcionalidade da Hydra Duo em uma versão divertida e que ensina as crianças a economizar água desde cedo.

Descarga com duplo acionamento.

São dois botões que regulam a quantidade de água a ser usada.

1 - Descarga com volume reduzido: limpeza rápida (aprox. 3 litros)

2 - Descarga completa: limpeza total (aprox. 6 litros)

Vermelho e azul

2545.VA.114.KD

válvula de descarga Hydra Duo Kids

2545.VA.112.KD

válvula de descarga Hydra Duo Kids

4900.VA.DUO.KD

acabamento Hydra Duo Kids



Vermelho e branco

2545.VB.114.KD

válvula de descarga Hydra Duo Kids

2545.VB.112.KD

válvula de descarga Hydra Duo Kids

4900.VB.DUO.KD

acabamento Hydra Duo Kids



- Descarga com duplo acionamento.
- Meia descarga: Aprox. 3 litros e descarga completa: Aprox. 6 litros.
- Disponível em duas bitolas
1 ½ " baixa pressão (2 a 10 m.c.a)
1 ¼ " alta pressão (10 a 40 m.c.a)
- Possui regulagem de vazão
- Acionamento suave através do mecanismo Soft-touch.
- Pintura em epóxi de alta resistência.
- Acabamento metálico.
- 10 anos de garantia.

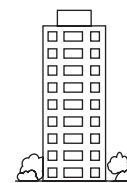

ALTA PRESSÃO
DN 32 (1 ¼")
100 a 400 Kpa
1,0 a 4,0 Kgf/cm²



BAIXA PRESSÃO
DN 40 (1 ½")
20 a 100 Kpa
0,2 a 1,0 Kgf/cm²

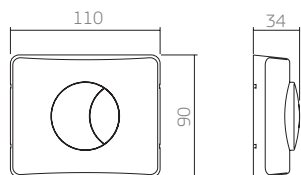

Kit Conversor disponível nas versões: vermelho com azul e vermelho com branco.

dimensões em milímetros



HYDRA ECO

Mais tecnologia para você economizar água.

Desenvolvida com base na crescente preocupação com a preservação do meio ambiente, a Hydra ECO tem fluxo de aproximadamente 6 litros por acionamento.

Essa inovação garante uma maior Economia no consumo de água.



- Evita o desperdício de água
- Válvula com fluxo de descarga de aproximadamente 6 litros
- Possui regulagem de vazão
- Acionamento suave
- Recomendável utilização com bacias de 6 litros
- Disponível em duas bitolas
1 ½" baixa pressão (2 a 10 mca)
1 ¼" alta pressão (10 a 40 mca)
- 10 anos de garantia
- Disponível na versão cromada

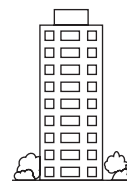

ALTA PRESSÃO
DN 32 (1 ¼")
100 a 400 Kpa
1,0 a 4,0 Kgf/cm²



BAIXA PRESSÃO
DN 40 (1 ½")
20 a 100 Kpa
0,2 a 1,0 Kgf/cm²

Cromado

2565.C.114
válvula de descarga
Hydra Eco

2565.C.112
válvula de descarga
Hydra Eco

4900.C.ECO
acabamento
Hydra Eco

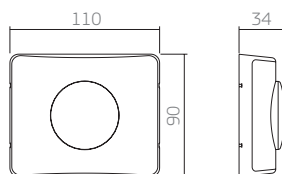

Kit Conversor disponível na versão: cromado.

dimensões em milímetros

NOVO

- Qualidade reconhecida
- Com tecnologia exclusiva que limita o fluxo em 6 litros por ciclo.
- Recomendável utilização com bacias de 6 litros.
- Disponível em duas bitolas: 1 ½" e 1 ¼"
- Pode ser instalada em alta ou baixa pressão
- Fácil Manutenção
- Acabamento anti-vandalismo
- Ideal para utilização em locais públicos
- Disponível na versão cromada

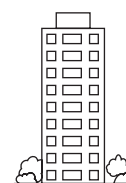

ALTA PRESSÃO
DN 32 (1 ¼")
100 a 400 Kpa
1,0 a 4,0 Kgf/cm²



BAIXA PRESSÃO
DN 40 (1 ½")
20 a 100 Kpa
0,2 a 1,0 Kgf/cm²

Cromado

2565.C.112.PRO
válvula de descarga
Hydra Eco Pro

2565.C.114.PRO
válvula de descarga
Hydra Eco Pro

4900.C.ECO.PRO
acabamento
Hydra Eco Pro

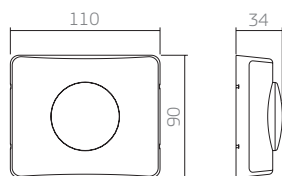

Kit Conversor disponível na versão: cromado.

dimensões em milímetros

NOVO

- Qualidade reconhecida.
- Alavanca que facilita e suaviza o acionamento.
- Com tecnologia exclusiva: Economiza água através de restritor de fluxo - independente do tempo de pressão a válvula limita o fluxo em 6 litros.
- Recomendável utilização com bacias de 6 litros.
- Disponível em duas bitolas: 1 1/2" e 1 1/4"
- Pode ser instalada em alta ou baixa pressão.
- Fácil manutenção.
- Canopla com sistema anti vandalismo.
- Ideal para utilização por pessoas portadoras de necessidades especiais e em locais públicos.
- Disponível na versão cromado.

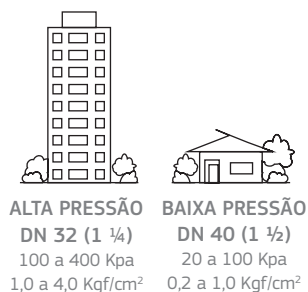

Cromado

2565.C.114.CONF
válvula de descarga
Hydra Eco Conforto

2565.C.112.CONF
válvula de descarga
Hydra Eco Conforto

4900.C.CONF
acabamento
Hydra Eco Conforto

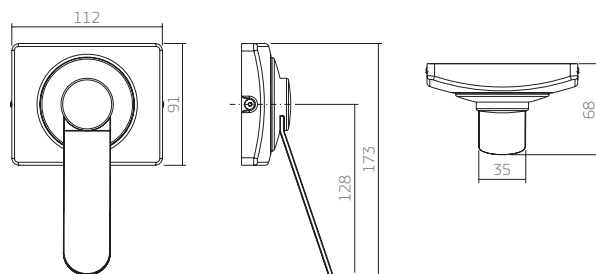

Kit Conversor disponível na versão: cromado.

dimensões em milímetros



HYDRA RETRÔ

Desenvolvida com base na crescente preocupação com a preservação do meio ambiente, a Hydra RETRÔ tem fluxo de aproximadamente 6 litros por acionamento.

Essa inovação garante uma maior Economia no consumo de água.

- Evita o desperdício de água
- Válvula com fluxo fixo de descarga de aproximadamente 6 litros
- Possui regulagem de vazão
- Acionamento suave
- Disponível em duas bitolas:
1 ½" baixa pressão (2 a 10 mca)
1 ¼" alta pressão (10 a 40 mca)
- 10 anos de garantia
- Disponível nas versões cromado e dourado

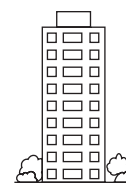

ALTA PRESSÃO
DN 32 (1 ¼")
100 a 400 Kpa
1,0 a 4,0 Kgf/cm²



BAIXA PRESSÃO
DN 40 (1 ½")
20 a 100 Kpa
0,2 a 1,0 Kgf/cm²

Cromado

2525.C.114
válvula de descarga
Hydra Retrô

2525.C.112
válvula de descarga
Hydra Retrô

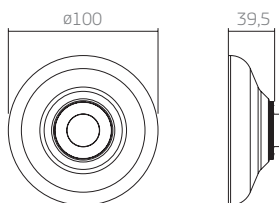

dimensões em milímetros





HYDRA PLUS

Design ultrafino com apenas 12 mm de espessura

Inovação no segmento de válvulas de descarga, a Hydra Plus é instalada com dentro da parede, ficando visível somente o acabamento.

- Acabamento menor
- Pode ser instalada com qualquer bacia convencional
- Acionamento suave através do mecanismo soft touch
- Possui regulagem de vazão
- Pode ser instalada em alta ou baixa pressão
- 10 anos de garantia
- Disponível nas versões cromado e dourado



PARA ALTA E BAIXA PRESSÃO
20 a 400 KPa - 0,2 a 4,0 Kgf/cm²

A válvula de descarga Hydra Plus é fornecida nas bitolas de DN.32 (1 ¼) e DN.40 (1 ½). Ambas podem ser utilizadas em alta ou baixa pressão de 2 a 40 mca.

Cromado

2555.C.114
válvula de descarga
Hydra Plus

2555.C.112
válvula de descarga
Hydra Plus

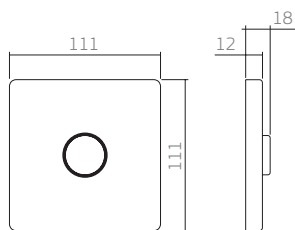

dimensões em milímetros



Kit Conversor disponível na versão: cromado.

dimensões em milímetros

Cromado

2550.C.112
válvula de descarga Hydra Max
2550.C.114
válvula de descarga Hydra Max
4900.C.MAX
acabamento Hydra Max



Dourado

2550.D.112
válvula de descarga Hydra Max
2550.D.114
válvula de descarga Hydra Max
4900.D.MAX
acabamento Hydra Max



Bege

2550.E.112.BE
válvula de descarga Hydra Max
2550.E.114.BE
válvula de descarga Hydra Max
4900.E.MAX.BE
acabamento Hydra Max



Cinza

2550.E.112.CZ
válvula de descarga Hydra Max
2550.E.114.CZ
válvula de descarga Hydra Max
4900.E.MAX.CZ
acabamento Hydra Max



Branco

2550.E.112.BR
válvula de descarga Hydra Max
2550.E.114.BR
válvula de descarga Hydra Max
4900.E.MAX.BR
acabamento Hydra Max



- Qualidade reconhecida
- Possui regulagem de vazão
- Pode ser ins talada com qualquer bacia convencional
- Disponível em duas bitolas: 1 ½" e 1 ¼"
- Fácil Manutenção
- Variedade de cores de acabamentos
- Pode ser instalada em alta ou baixa de pressão
- 10 anos de garantia



PARA ALTA E BAIXA PRESSÃO
20 a 400 KPa - 0,2 a 4,0 Kg/cm²

A válvula de descarga Hydra Max é fornecida nas bitolas de DN.32 (1 ¼) e DN.40 (1 ½). Ambas podem ser utilizadas em alta ou baixa pressão de 2 a 40 mca.

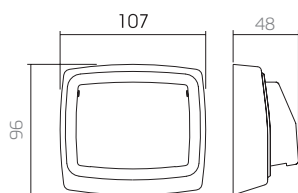

dimensões em milímetros

Válvulas com acabamento metálico

Cromado

2590.C.112 / válvula de descarga Hydra Clean
2590.C.114 / válvula de descarga Hydra Clean



Dourado

4900.D.CLN / acabamento Hydra Clean



Branco

4900.E.CLN.BR / acabamento Hydra Clean



Válvulas com acabamento em ABS

Branco

2590.PC.112.BR / válvula de descarga Hydra Clean
2590.PC.114.BR / válvula de descarga Hydra Clean
4900.PC.CLN.BR / acabamento Hydra Clean



NOVO

Bege

2590.PC.112.BE / válvula de descarga Hydra Clean
2590.PC.114.BE / válvula de descarga Hydra Clean
4900.PC.CLN.BE / acabamento Hydra Clean



NOVO

Cinza

2590.PC.112.CZ / válvula de descarga Hydra Clean
2590.PC.114.CZ / válvula de descarga Hydra Clean
4900.PC.CLN.CZ / acabamento Hydra Clean



NOVO

- Qualidade reconhecida
- Possui regulagem de vazão
- Pode ser instalada com qualquer bacia convencional
- Disponível em duas bitolas: 1 ½" e 1 ¼"
- Design clean
- Pode ser instalada em alta ou baixa de pressão
- Fácil Manutenção
- Variedade de cores de acabamentos
- 10 anos de garantia



PARA ALTA E BAIXA PRESSÃO
20 a 400 KPa - 0,2 a 4,0 Kgf/cm²

A válvula de descarga Hydra Clean é fornecida nas bitolas de DN.32 (1 ¼) e DN.40 (1 ½). Ambas podem ser utilizadas em alta ou baixa pressão de 2 a 40 mca.

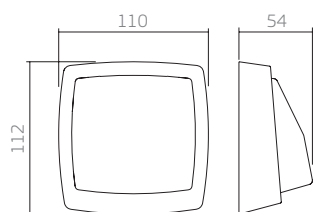

dimensões em milímetros



- Qualidade reconhecida
- Recomendável utilização com bacias de 6 litros
- Disponível em duas bitolas: 1 ½" e 1 ¼"
- Pode ser instalada em alta ou baixa pressão
- Fácil Manutenção
- Acabamento em latão fundido com 3 mm de espessura
- Acabamento anti-vandalismo
- Ideal para utilização em locais públicos
- Disponível na versão cromada

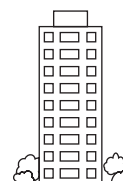

ALTA PRESSÃO
DN 32 (1 ¼)
 100 a 400 Kpa
 1,0 a 4,0 Kgf/cm²



BAIXA PRESSÃO
DN 40 (1 ½)
 20 a 100 Kpa
 0,2 a 1,0 Kgf/cm²

Cromado

2551.C.112
 válvula de descarga
 Hydra Max Pro

2551.C.114
 válvula de descarga
 Hydra Max Pro

4900.C.PRO
 acabamento
 Hydra Max Pro

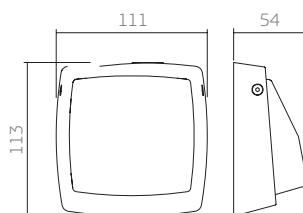

dimensões em milímetros



Base para válvula Hydra Max, Clean e Pro

4550.504
base DN.40 (1 1/2")

4550.404
base DN.32 (1 1/4")



4686.325
reparo válvula
Hydra Clean, Max e Pro.



Acabamentos compatíveis



Hydra Max



Hydra Clean



Hydra Pro

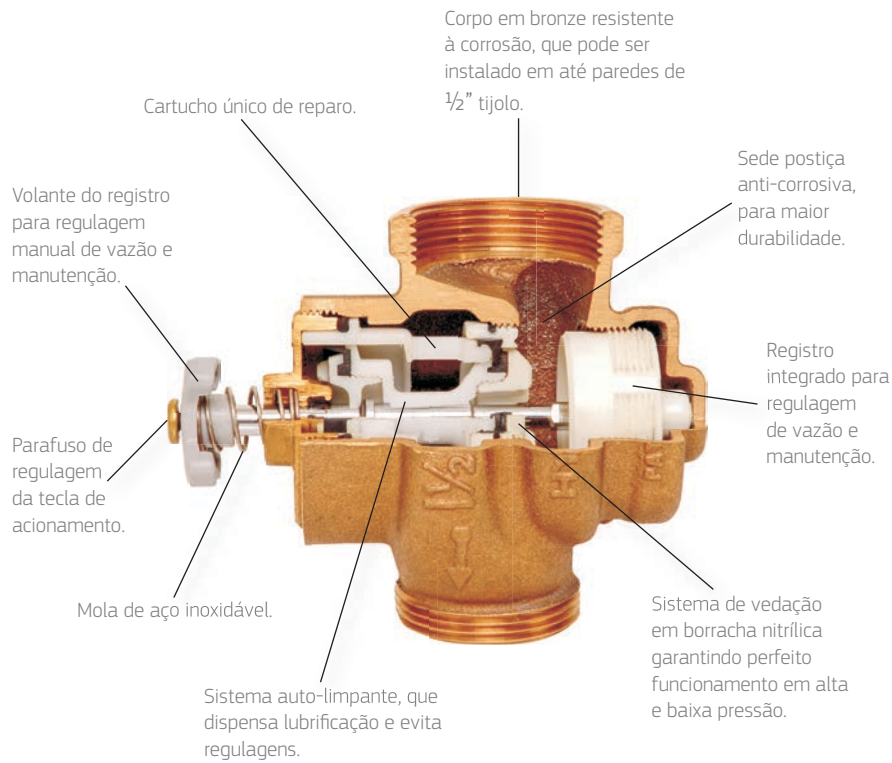

dimensões em milímetros

Base para válvula Hydra Duo

4545.500
base DN.40 (1 1/2")

4545.400
base DN.32 (1 1/4")

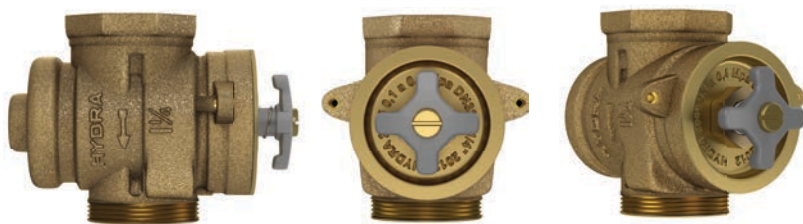

Acabamento compatível



Hydra Duo

Kit conversor Hydra

Se você tem em sua casa uma válvula Max, Clean ou Pro e deseja trocá-las por uma Hydra Duo, faça a conversão utilizando o Kit Conversor Hydra.



- 4916.C.114.DUO - 4916.C.112.DUO
- 4916.PC.114.DUO.BE - 4916.PC.112.DUO.BE
- 4916.PC.114.DUO.CZ - 4916.PC.112.DUO.CZ
- 4916.PC.114.DUO.BR - 4916.PC.112.DUO.BR
- 4916.PC.114.DUO.PT - 4916.PC.112.DUO.PT
- 4916.D.114.DUO.GLD - 4916.D.112.DUO.GLD
- 4916.VA.114.DUO.KD - 4916.VA.112.DUO.KD
- 4916.VB.114.DUO.KD - 4916.VB.112.DUO.KD



- 4916.C.114.DUO.PRO - 4916.C.112.DUO.PRO

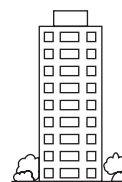

ALTA PRESSÃO
DN 32 (1 1/4")
100 a 400 Kpa
1,0 a 4,0 Kgf/cm²



BAIXA PRESSÃO
DN 40 (1 1/2")
20 a 100 Kpa
0,2 a 1,0 Kgf/cm²

dimensões em milímetros

Kit conversor Hydra

Se você tem em sua casa uma válvula Max, Clean ou Pro e deseja trocá-las por uma Hydra Eco, Hydra Eco Pro ou Hydra Eco Conforto, faça a conversão utilizando o Kit Conversor Hydra.



4916.C.114.ECO.PRO - 4916.C.112.ECO.PRO



4916.C.114.ECO - 4916.C.112.ECO



4916.C.114.CONF - 4916.C.112.CONF

Base para válvula Hydra Eco

4565.500
base DN.40 (1 ½")

4565.400
base DN.32 (1 ¼")



Acabamentos compatíveis



Hydra Eco



Hydra Eco Pro

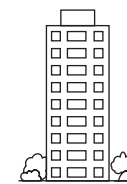

ALTA PRESSÃO
DN 32 (1 ¼)
100 a 400 Kpa
1,0 a 4,0 Kgf/cm²



BAIXA PRESSÃO
DN 40 (1 ½)
20 a 100 Kpa
0,2 a 1,0 Kgf/cm²

dimensões em milímetros

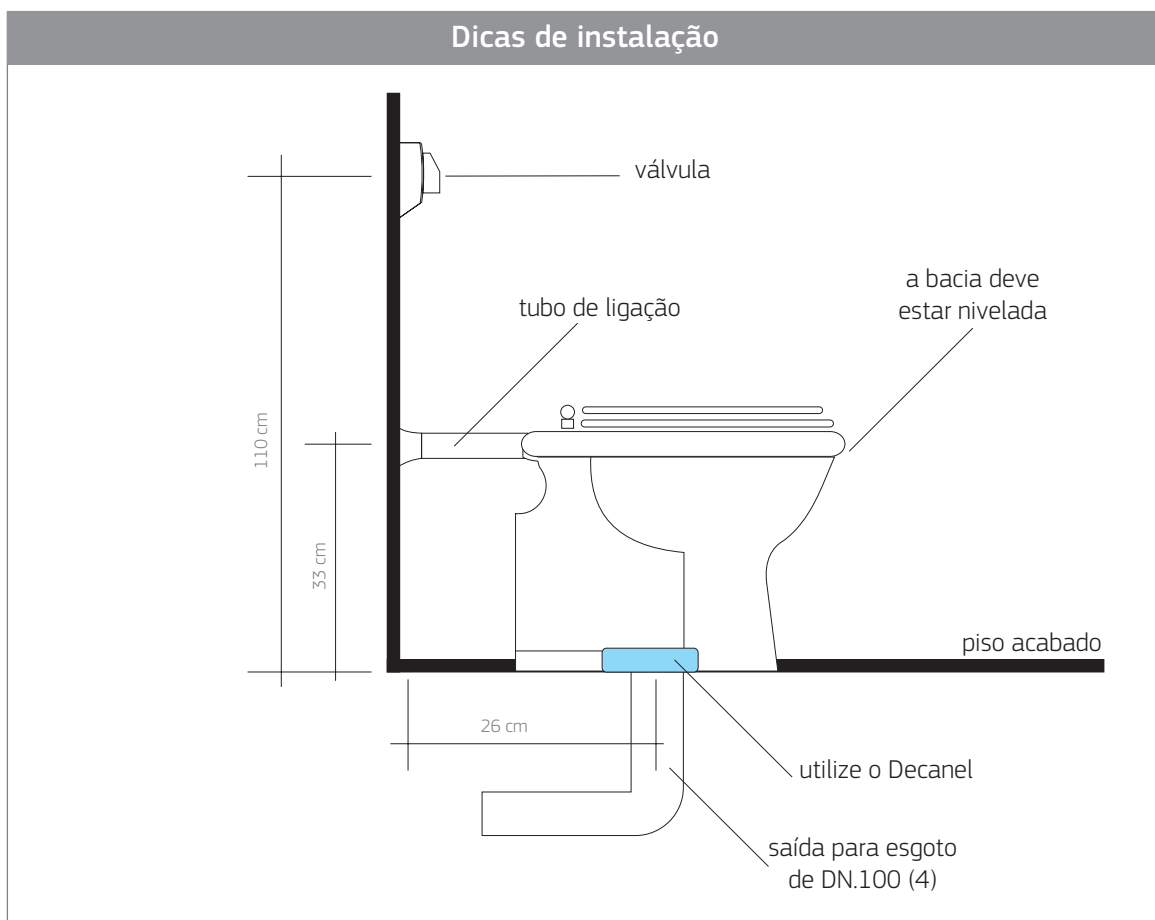

dimensões em milímetros

NOVAS VÁLVULAS SEM QUEBRADEIRA NO BANHEIRO.

Como funciona?

Se você tem em sua casa uma válvula Max, Clean ou Pro e deseja trocá-las por uma Nova Hydra, faça a conversão utilizando o Kit Conversor Hydra.

Por que trocar pelas novas Hydras?

Produzidas com tecnologia de ponta, as Novas Hydras possuem design diferenciado, contribuem com a economia de água e ajudam na preservação do planeta.

O que já é bom, pode ser ainda melhor.

Adquirindo o Kit Conversor Hydra, você converte as válvulas Max, Clean e Pro em modelos Nova Hydra sem a necessidade de obras no banheiro.

 <p>Hydra Max</p>	 <p>Hydra Clean</p>	 <p>Hydra Pro</p>
<p>4916.C.114.DUO - 4916.C.112.DUO 4916.PC.114.DUO.BE - 4916.PC.112.DUO.BE 4916.PC.114.DUO.CZ - 4916.PC.112.DUO.CZ 4916.PC.114.DUO.BR - 4916.PC.112.DUO.BR 4916.PC.114.DUO.PT - 4916.PC.112.DUO.PT 4916.D.114.DUO.GLD - 4916.D.112.DUO.GLD 4916.VA.114.DUO.KD - 4916.VA.112.DUO.KD 4916.VB.114.DUO.KD - 4916.VB.112.DUO.KD</p>  <p>Hydra Duo</p>	<p>4916.C.114.DUO.PRO 4916.C.112.DUO.PRO</p>  <p>Hydra Duo PRO</p>	<p>4916.C.PLS</p>  <p>Hydra Plus</p>
<p>4916.C.114.ECO 4916.C.112.ECO</p>  <p>Hydra Eco</p>	<p>4916.C.114.ECO.PRO 4916.C.112.ECO.PRO</p>  <p>Hydra Eco Pro</p>	<p>4916.C.114.CONF 4916.C.112.CONF</p>  <p>Hydra Eco Conforto</p>

dimensões em milímetros

FAÇA PARTE DA NOSSA REDE.

Faça parte da nossa rede e acompanhe a empresa e suas atividades em diversos setores, também é possível curtir e compartilhar posts e tweets sobre temas relacionados ao universo da sustentabilidade, design, decoração e cultura.



Facebook/Decaoficial



Twitter/Decaoficial



Blog.deca.com.br



deca 

Duratex S.A.

Showroom Deca

Av. Brasil, 1589 - São Paulo - T. (11) 3088 2744

Atendimento ao consumidor: 0800 011 7073

www.deca.com.br